

Groupe d'Annecy

Laboratoire
d'Annecy-le-Vieux de
Physique des Particules

Groupe de Lyon

Ecole Normale
Supérieure de Lyon

Dictionary on Lie Superalgebras

L. Frappat, P. Sorba

*Laboratoire de Physique Théorique ENSLAPP*¹
Chemin de Bellevue, BP 110, F-74941 Annecy-le-Vieux cedex, France
and
46, avenue d'Italie, F-69364 Lyon cedex 07, France
e-mail: frappat@lapp.in2p3.fr and sorba@lapp.in2p3.fr

and

A. Sciarrino

Università di Napoli "Federico II" and I.N.F.N. Sezione di Napoli
Mostra d'Oltremare, Pad. 19, I-80125 Napoli, Italy
e-mail: sciarrino@napoli.infn.it

ENSLAPP-AL-600/96
DSF-T-30/96
hep-th/9607161
July 1996

¹URA 1436 du CNRS, associée à l'Ecole Normale Supérieure de Lyon et à l'Université de Savoie.

Foreword

The main definitions and properties of Lie superalgebras are proposed *à la façon de* a short dictionary, the different items following the alphabetical order. The main topics deal with the structure of simple Lie superalgebras and their finite dimensional representations; rather naturally, a few pages are devoted to supersymmetry.

This modest booklet has two ambitious goals: to be elementary and easy to use. The beginner is supposed to find out here the main concepts on superalgebras, while a more experimented theorist should recognize the necessary tools and informations for a specific use.

It has not been our intention to provide an exhaustive set of references but, in the quoted papers, the reader must get the proofs and developments of the items which are presented hereafter, as well as a more detailed bibliography.

Actually, this work can be considered as the continuation of a first section, entitled "Lie algebras for physicists" written fifteen years ago (see ref. [40]). The success of this publication as well as the encouragements of many of our colleagues convinced us to repeat the same exercise for superalgebras. During the preparation of the following pages, it has appeared to us necessary to update the Lie algebra part. In this respect we are writing a new version of this first section, by adding or developing some properties which are of some interest these recent years in the domains of theoretical physics where continuous symmetries are intensively used (elementary particle physics, integrable systems, statistical mechanics, e.g.). Finally, a third section is in preparation and deals with infinite dimensional symmetries – Kac-Moody algebras and superalgebras, two-dimensional conformal symmetry and its extensions. When completed, we have in mind to gather the three parts in a unique volume. However, we have preferred to display right now the second part on superalgebras since we do not see any reason to keep in a drawer this document which might be of some help for physicists. Moreover, we hope to receive from the interested readers suggestions and corrections for a better final version.

Contents

| | |
|---|----|
| 1 Automorphisms | 1 |
| 2 Cartan matrices | 1 |
| 3 Cartan subalgebras | 3 |
| 4 Cartan type superalgebras | 3 |
| 5 Casimir invariants | 7 |
| 6 Centralizer, Center, Normalizer of a Lie superalgebra | 10 |
| 7 Characters and supercharacters | 10 |
| 8 Classical Lie superalgebras | 12 |
| 9 Classification of simple Lie superalgebras | 14 |
| 10 Clifford algebras | 14 |
| 11 Decompositions w.r.t. $osp(1 2)$ subalgebras | 16 |
| 12 Decompositions w.r.t. $sl(1 2)$ subalgebras | 17 |
| 13 Derivation of a Lie superalgebra | 20 |
| 14 Dirac matrices | 20 |
| 15 Dynkin diagrams | 20 |
| 16 Embeddings of $osp(1 2)$ | 21 |
| 17 Embeddings of $sl(2 1)$ | 22 |
| 18 Exceptional Lie superalgebra $F(4)$ | 24 |
| 19 Exceptional Lie superalgebra $G(3)$ | 26 |
| 20 Exceptional Lie superalgebras $D(2, 1; \alpha)$ | 28 |
| 21 Gelfand-Zetlin basis | 30 |
| 22 Grassmann algebras | 32 |
| 23 Killing form | 32 |
| 24 Lie superalgebra, subalgebra, ideal | 34 |

| | | |
|----|---|----|
| 25 | Matrix realizations of the classical Lie superalgebras | 35 |
| 26 | Nilpotent and solvable Lie superalgebras | 36 |
| 27 | Orthosymplectic superalgebras | 37 |
| 28 | Oscillator realizations: Cartan type superalgebras | 40 |
| 29 | Oscillator realizations: orthosymplectic and unitary series | 41 |
| 30 | Oscillator realizations: strange series | 44 |
| 31 | Real forms | 45 |
| 32 | Representations: basic definitions | 45 |
| 33 | Representations: exceptional superalgebras | 46 |
| 34 | Representations: highest weight representations | 49 |
| 35 | Representations: induced modules | 50 |
| 36 | Representations: orthosymplectic superalgebras | 52 |
| 37 | Representations: reducibility | 55 |
| 38 | Representations: star and superstar representations | 56 |
| 39 | Representations: typicality and atypicality | 58 |
| 40 | Representations: unitary superalgebras | 59 |
| 41 | Roots, root systems | 60 |
| 42 | Schur's lemma | 62 |
| 43 | Serre-Chevalley basis | 62 |
| 44 | Simple root systems | 63 |
| 45 | Simple and semi-simple Lie superalgebras | 66 |
| 46 | Spinors (in the Lorentz group) | 66 |
| 47 | Strange superalgebras $P(n)$ | 69 |
| 48 | Strange superalgebras $Q(n)$ | 71 |
| 49 | Subsuperalgebras (regular) | 72 |

| | | |
|----|--|-----|
| 50 | Subsuperalgebras (singular) | 73 |
| 51 | Superalgebra, subsuperalgebra | 75 |
| 52 | Superalgebra $osp(1 2)$ | 75 |
| 53 | Superalgebra $sl(1 2)$ | 77 |
| 54 | Superconformal algebra | 80 |
| 55 | Supergroups | 81 |
| 56 | Supergroups of linear transformations | 82 |
| 57 | Supermatrices | 82 |
| 58 | Superspace and superfields | 85 |
| 59 | Supersymmetry algebra: definition | 87 |
| 60 | Supersymmetry algebra: representations | 89 |
| 61 | Unitary superalgebras | 91 |
| 62 | Universal enveloping algebra | 93 |
| 63 | Weyl group | 94 |
| 64 | Z-graded Lie superalgebras | 95 |
| | List of Tables | 96 |
| | Tables | 98 |
| | Bibliography | 135 |

Main Notations

| | |
|--|--|
| $[\cdot, \cdot]$ | commutator |
| $\{\cdot, \cdot\}$ | anticommutator |
| $[\cdot, \cdot]$ | super or \mathbb{Z}_2 -graded commutator (Lie superbracket) |
| (\cdot, \cdot) | inner product, Killing form |
| $\mathbb{N}, \mathbb{Z}, \mathbb{R}, \mathbb{C}, \mathbb{H}$ | sets of positive integers, of integers, of real numbers, of complex numbers, of quaternions |
| \mathbb{K} | commutative field of characteristic zero |
| $\mathcal{A}, \mathcal{A}_{\bar{0}}, \mathcal{A}_{\bar{1}}$ | (super)algebra, even/odd part of a superalgebra |
| \mathcal{B} | Borel subalgebra |
| $\mathcal{G}, \mathcal{G}_{\bar{0}}, \mathcal{G}_{\bar{1}}$ | Lie superalgebra, even/odd part of a Lie superalgebra |
| \mathcal{H} | Cartan subalgebra |
| \mathcal{N} | nilpotent subalgebra |
| \mathcal{V} | module, representation space |
| $A(m, n) \simeq sl(m+1 n+1)$ | unitary basic superalgebras |
| $B(m, n) \simeq osp(2m+1 2n)$ | orthosymplectic basic superalgebras |
| $C(n+1) \simeq osp(2 2n)$ | ” ” ” |
| $D(m, n) \simeq osp(2m 2n)$ | ” ” ” |
| $\bar{0}, \bar{1}$ | \mathbb{Z}_2 -gradation of a superalgebra |
| Aut | automorphism group |
| Der | derivation algebra |
| Int | inner automorphism group |
| Out | set of outer automorphisms |
| $\Delta, \Delta_{\bar{0}}, \Delta_{\bar{1}}$ | root system, even root system, odd root system |
| $\Delta^+, \Delta_{\bar{0}}^+, \Delta_{\bar{1}}^+$ | positive roots, positive even roots, positive odd roots |
| Δ^0 | simple root system |

1 Automorphisms

Let $\mathcal{G} = \mathcal{G}_{\bar{0}} \oplus \mathcal{G}_{\bar{1}}$ be a simple Lie superalgebra. An automorphism Φ of \mathcal{G} is a bijective homomorphism from \mathcal{G} into itself which respects the \mathbb{Z}_2 -gradation, that is $\Phi(\mathcal{G}_{\bar{0}}) \subset \mathcal{G}_{\bar{0}}$ and $\Phi(\mathcal{G}_{\bar{1}}) \subset \mathcal{G}_{\bar{1}}$. The automorphisms of \mathcal{G} form a group denoted by $\text{Aut}(\mathcal{G})$. The group $\text{Int}(\mathcal{G})$ of inner automorphisms of \mathcal{G} is the group generated by the automorphisms of the form $X \mapsto gXg^{-1}$ with $g = \exp Y$ where $X \in \mathcal{G}$ and $Y \in \mathcal{G}_{\bar{0}}$. Every inner automorphism of $\mathcal{G}_{\bar{0}}$ can be extended to an inner automorphism of \mathcal{G} . The automorphisms of \mathcal{G} which are not inner are called outer automorphisms.

In the case of a simple Lie algebra \mathcal{A} , the quotient of the automorphism group by the inner automorphism group $\text{Aut}(\mathcal{A})/\text{Int}(\mathcal{A})$ – called the factor group $F(\mathcal{A})$ – is isomorphic to the group of symmetries of the Dynkin diagram of \mathcal{A} .

In the same way, the outer automorphisms of a basic Lie superalgebra \mathcal{G} can also be connected with some Dynkin diagram (\rightarrow) of \mathcal{G} . It is possible to write $\text{Out}(\mathcal{G}) = \text{Aut}(\mathcal{G})/\text{Int}(\mathcal{G})$, where $\text{Int}(\mathcal{G}) \simeq \mathcal{G}_{\bar{0}}$, and $\text{Out}(\mathcal{G})$ can be reconstructed in general by looking at the symmetries of the Dynkin diagrams of \mathcal{G} . More precisely, when $\text{Out}(\mathcal{G})$ is not trivial, there exists at least one Dynkin diagram of \mathcal{G} which exhibits a symmetry associated to $\text{Out}(\mathcal{G})$ – except in the case of $sl(2m+1|2n+1)$. The table I lists the outer automorphisms of the basic Lie superalgebras. For more details, see ref. [43].

| superalgebra \mathcal{G} | $\text{Out}(\mathcal{G})$ | superalgebra \mathcal{G} | $\text{Out}(\mathcal{G})$ |
|---------------------------------|------------------------------------|--|---------------------------|
| $A(m, n)$ ($m \neq n \neq 0$) | \mathbb{Z}_2 | $D(m, n)$ | \mathbb{Z}_2 |
| $A(1, 1)$ | \mathbb{Z}_2 | $D(2, 1; -2)$ | \mathbb{Z}_2 |
| $A(0, 2n - 1)$ | \mathbb{Z}_2 | $D(2, 1; -1/2)$ | \mathbb{Z}_2 |
| $A(n, n)$ ($n \neq 0, 1$) | $\mathbb{Z}_2 \times \mathbb{Z}_2$ | $D(2, 1; e^{2i\pi/3})$ | \mathbb{Z}_3 |
| $A(0, 2n)$ | \mathbb{Z}_4 | $D(2, 1; e^{4i\pi/3})$ | \mathbb{Z}_3 |
| $B(m, n)$ | \mathbb{I} | $D(2, 1; \alpha)$ for generic α | \mathbb{I} |
| $C(n + 1)$ | \mathbb{Z}_2 | $F(4), G(3)$ | \mathbb{I} |

Table I: Outer automorphisms of the basic Lie superalgebras.

\rightarrow Dynkin diagram, Roots, Weyl group.

2 Cartan matrices

Let \mathcal{G} be a basic Lie superalgebra with Cartan subalgebra \mathcal{H} . To a simple root system $\Delta^0 = (\alpha_1, \dots, \alpha_r)$ of \mathcal{G} , it is always possible to associate a matrix $A = (a_{ij})$, called the

Cartan matrix, with the following conditions:

$$\begin{aligned} [H_i, H_j] &= 0, \\ [H_i, E_{\pm\alpha_j}] &= \pm a_{ij} E_{\pm\alpha_j}, \\ \llbracket E_{\alpha_i}, E_{-\alpha_j} \rrbracket &= \delta_{ij} H_i, \end{aligned}$$

the set (H_1, \dots, H_r) generating the Cartan subalgebra \mathcal{H} .

For all basic Lie superalgebras, there exists a non-degenerate inner product (\cdot, \cdot) such that

$$\begin{aligned} (E_{\alpha_i}, E_{-\alpha_j}) &= (E_{\alpha_j}, E_{-\alpha_j}) \delta_{ij} \\ (H_i, H_j) &= (E_{\alpha_j}, E_{-\alpha_j}) a_{ij} \end{aligned}$$

Notice that this inner product coincides with the Killing form (\rightarrow) except for $A(n, n)$, $D(n+1, n)$ and $D(2, 1; \alpha)$ for which the Killing form vanishes.

A non-degenerate bilinear form on \mathcal{H}^* (\rightarrow Simple root systems) is then defined by $(\alpha_i, \alpha_j) \equiv (H_i, H_j)$, where α_i, α_j are simple roots, such a form being invariant under the Weyl group of \mathcal{G} , generated by the reflections of the even roots.

Definition: For each basic Lie superalgebra, there exists a simple root system for which the number of odd roots is the smallest one. Such a simple root system is called the distinguished simple root system (\rightarrow). The associated Cartan matrix is called the *distinguished Cartan matrix*.

The distinguished Cartan matrices can be found in Tables 4 to 12.

One can also use symmetric Cartan matrices. A symmetric Cartan matrix $A^s = (a'_{ij})$ can be obtained by rescaling the Cartan generators $H_i \rightarrow H'_i = H_i / (E_{\alpha_i}, E_{-\alpha_i})$. The commutation relations then become $[H'_i, E_{\pm\alpha_j}] = \pm a'_{ij} E_{\pm\alpha_j}$ and $\llbracket E_{\alpha_i}, E_{-\alpha_j} \rrbracket = (E_{\alpha_i}, E_{-\alpha_i}) H'_i \delta_{ij}$, from which it follows that $a'_{ij} = (H'_i, H'_j)$.

If one defines the matrix $D_{ij} = d_i \delta_{ij}$ where the rational coefficients d_i satisfy $d_i a_{ij} = d_j a_{ji}$, the (distinguished) symmetric Cartan matrix is given by $A^s = DA$. One has:

$$\begin{aligned} d_i &= (\underbrace{1, \dots, 1}_{m+1}, \underbrace{-1, \dots, -1}_n) \text{ for } A(m, n), \\ d_i &= (\underbrace{1, \dots, 1}_n, \underbrace{-1, \dots, -1}_{m-1}, -1/2) \text{ for } B(m, n), \\ d_i &= (\underbrace{1, \dots, 1}_{n-1}, 1/2) \text{ for } B(0, n), \\ d_i &= (1, \underbrace{-1, \dots, -1}_{n-1}, -2) \text{ for } C(n+1), \\ d_i &= (\underbrace{1, \dots, 1}_n, \underbrace{-1, \dots, -1}_m) \text{ for } D(m, n). \end{aligned}$$

→ Killing form, Simple root systems.

3 Cartan subalgebras

Let $\mathcal{G} = \mathcal{G}_{\bar{0}} \oplus \mathcal{G}_{\bar{1}}$ be a classical Lie superalgebra. A Cartan subalgebra \mathcal{H} of \mathcal{G} is defined as the maximal nilpotent (→) subalgebra of \mathcal{G} coinciding with its own normalizer, that is

$$\mathcal{H} \text{ nilpotent and } \{X \in \mathcal{G} \mid [X, \mathcal{H}] \subseteq \mathcal{H}\} = \mathcal{H}$$

In most cases (for basic Lie superalgebras e.g.), a Cartan subalgebra \mathcal{H} reduces to the Cartan subalgebra of the even part $\mathcal{G}_{\bar{0}}$ (then the Cartan subalgebras of a Lie superalgebra are conjugate since the Cartan subalgebras of a Lie algebra are conjugate and any inner automorphism of the even part $\mathcal{G}_{\bar{0}}$ can be extended to an inner automorphism of \mathcal{G}).

In the case of the strange superalgebra $Q(n)$, the Cartan subalgebra \mathcal{H} does not coincide with the Cartan subalgebra of the even part $sl(n)$, but admits also an odd part: $\mathcal{H} \cap \mathcal{G}_{\bar{1}} \neq \emptyset$. Since the odd generators of \mathcal{H} change the gradation of the generators on which they act, it is rather convenient to give the root decomposition of $Q(n)$ with respect to $\mathcal{H}_{\bar{0}} = \mathcal{H} \cap \mathcal{G}_{\bar{0}}$ instead of \mathcal{H} .

From what precedes, all Cartan subalgebras of a classical superalgebra \mathcal{G} have the same dimension. By definition, the dimension of a Cartan subalgebra \mathcal{H} is the rank of \mathcal{G} :

$$\text{rank } \mathcal{G} = \dim \mathcal{H}$$

4 Cartan type superalgebras

The Cartan type Lie superalgebras are superalgebras in which the representation of the even subalgebra on the odd part is not completely reducible (→ Classification of simple Lie algebras). The Cartan type simple Lie superalgebras are classified into four infinite families called $W(n)$ with $n \geq 2$, $S(n)$ with $n \geq 3$, $\tilde{S}(n)$ and $H(n)$ with $n \geq 4$. $S(n)$ and $\tilde{S}(n)$ are called special Cartan type Lie superalgebras and $H(n)$ Hamiltonian Cartan type Lie superalgebras. Strictly speaking, $W(2)$, $S(3)$ and $H(4)$ are not Cartan type superalgebras since they are isomorphic to classical ones (see below).

4.1 Cartan type superalgebras $W(n)$

Consider $\Gamma(n)$ the Grassmann algebra (→) of order n with generators $\theta_1, \dots, \theta_n$ and relations $\theta_i \theta_j = -\theta_j \theta_i$. The \mathbb{Z}_2 -gradation is induced by setting $\deg \theta_i = \bar{1}$. Let $W(n)$

be the derivation superalgebra of $\Gamma(n)$: $W(n) = \text{Der } \Gamma(n)$. Any derivation $D \in W(n)$ is written as

$$D = \sum_{i=1}^n P_i \frac{\partial}{\partial \theta_i}$$

where $P_i \in \Gamma(n)$ and the action of the θ -derivative is defined by

$$\frac{\partial \theta_j}{\partial \theta_i} = \delta_{ij}$$

The \mathbb{Z}_2 -gradation of $\Gamma(n)$ induces a consistent \mathbb{Z} -gradation of $W(n)$ (\rightarrow \mathbb{Z} -graded superalgebras) by

$$W(n)_k = \left\{ \sum_{i=1}^n P_i \frac{\partial}{\partial \theta_i}, \quad P_i \in \Gamma(n), \quad \deg P_i = k + 1 \right\} \quad \text{where} \quad -1 \leq k \leq n - 1$$

One has

$$W(n) = \bigoplus_{k=-1}^{n-1} W(n)_k$$

where

$$\llbracket W(n)_i, W(n)_j \rrbracket \subset W(n)_{i+j}$$

The superalgebra $W(n)$ has the following properties:

- $W(n)$ has dimension $n2^n$, the number of even generators being equal to the number of odd generators.
- The superalgebra $W(n)$ is simple for $n \geq 2$.
- The semi-simple part of $W(n)_0$ is isomorphic to $gl(n)$.
- The superalgebra $W(2)$ is isomorphic to $A(1, 0)$.
- Every automorphism of $W(n)$ with $n \geq 3$ is induced by an automorphism of $\Gamma(n)$.
- The superalgebra $W(n)$ is transitive (\rightarrow \mathbb{Z} -graded superalgebras).
- $W(n)$ is universal as a \mathbb{Z} -graded Lie superalgebra. More precisely, if $\mathcal{G} = \bigoplus_{i \geq -1} \mathcal{G}_i$ is a transitive \mathbb{Z} -graded superalgebra with $\dim \mathcal{G}_{-1} = n$, then there is an embedding of \mathcal{G} in $W(n)$ preserving the \mathbb{Z} -gradation.
- The representations of $sl(n)$ in the subspace $W(n)_i$ ($i = -1, 0, \dots, n-1$) are in Young tableaux notation $[2^{i+1}1^{n-2-i}] \oplus [1^i]$ where the second representation appears only for $i \geq 0$ and $[1^0]$ has to be read as the singlet. For example we have (the subscripts stand for the \mathbb{Z} -gradation indices i):

$$\begin{aligned}
\text{for } W(3) & \quad (\bar{3})_{-1} \oplus (8 \oplus 1)_0 \oplus (\bar{6} \oplus 3)_1 \oplus (\bar{3})_2 \\
\text{for } W(4) & \quad (\bar{4})_{-1} \oplus (15 \oplus 1)_0 \oplus (\bar{20} \oplus 4)_1 \oplus (\bar{10} \oplus 6)_2 \oplus (\bar{4})_3 \\
\text{for } W(5) & \quad (\bar{5})_{-1} \oplus (24 \oplus 1)_0 \oplus (\bar{45} \oplus 5)_1 \oplus (\bar{40} \oplus 10)_2 \oplus (\bar{15} \oplus \bar{10})_3 \oplus (\bar{5})_4
\end{aligned}$$

4.2 Cartan type superalgebras $S(n)$ and $\tilde{S}(n)$

The Cartan type Lie superalgebras $S(n)$ and $\tilde{S}(n)$, called special Lie superalgebras, are constructed as follows. Consider $\Theta(n)$ the associative superalgebra over $\Gamma(n)$ with generators denoted by $\xi\theta_1, \dots, \xi\theta_n$ and relations $\xi\theta_i \wedge \xi\theta_j = -\xi\theta_j \wedge \xi\theta_i$. A \mathbb{Z}_2 -gradation is induced by setting $\deg \xi\theta_i = \bar{1}$. Any element of $\Theta(n)$ is written as

$$\omega_k = \sum_{i_1 < \dots < i_k} a_{i_1 \dots i_k} \xi\theta_{i_1} \wedge \dots \wedge \xi\theta_{i_k}$$

where $a_{i_1 \dots i_k} \in \Gamma(n)$.

One defines then the volume form superalgebra $S(\omega)$ as a $W(n)$ subsuperalgebra by

$$S(\omega) = \{D \in W(n) \mid D(\omega) = 0\}$$

where $\omega = a(\theta_1, \dots, \theta_n) \xi\theta_1 \wedge \dots \wedge \xi\theta_n$ and $a \in \Gamma(n)_{\bar{0}}$, $a(0) \neq 0$.

Any element of $S(\omega)$ has the form

$$\sum_{i=1}^n P_i \frac{\partial}{\partial \theta_i} \quad \text{with} \quad \sum_{i=1}^n \frac{\partial(aP_i)}{\partial \theta_i} = 0$$

One sets also

$$S(n) = S(\omega = \xi\theta_1 \wedge \dots \wedge \xi\theta_n) = \{D \in W(n) \mid D(\xi\theta_1 \wedge \dots \wedge \xi\theta_n) = 0\}$$

and

$$\begin{aligned}
\tilde{S}(n) &= S(\omega = (1 + \theta_1 \dots \theta_n) \xi\theta_1 \wedge \dots \wedge \xi\theta_n) \\
&= \{D \in W(n) \mid D((1 + \theta_1 \dots \theta_n) \xi\theta_1 \wedge \dots \wedge \xi\theta_n) = 0\} \quad \text{where } n \text{ is even}
\end{aligned}$$

Elements of $S(n)$ are thus divergenceless derivations of $W(n)$:

$$S(n) = \left\{ \sum_{i=1}^n P_i \frac{\partial}{\partial \theta_i} \in W(n) \mid \sum_{i=1}^n \frac{\partial P_i}{\partial \theta_i} = 0 \right\}$$

The Lie superalgebras $S(n)$ and $\tilde{S}(n)$ have the following properties:

- $S(n)$ and $\tilde{S}(n)$ have dimension $(n-1)2^n + 1$, the number of even generators being less (resp. greater) by 1 than the number of odd generators for n even (resp. odd).

- The superalgebra $S(n)$ is simple for $n \geq 3$ and $\tilde{S}(n)$ is simple for $n \geq 4$.
- The semi-simple part of $S(n)_0$ and $\tilde{S}(n)_0$ is isomorphic to $sl(n)$.
- The superalgebra $S(3)$ is isomorphic to $P(3)$.
- the \mathbb{Z} -graded Lie superalgebra $S(n)$ is transitive (\rightarrow \mathbb{Z} -graded superalgebras).
- Every automorphism of $S(n)$ with $n \geq 3$ and $\tilde{S}(n)$ with $n \geq 4$ is induced by an automorphism of $\Gamma(n)$.
- Every superalgebra $S(\omega)$ is isomorphic either to $S(n)$ or $\tilde{S}(n)$.
- The representation of $sl(n)$ in the subspace $S(n)_i$ ($i = -1, 0, \dots, n-2$) is in Young tableaux notation $[2^{i+1}1^{n-2-i}]$. For example we have (the subscripts stand for the \mathbb{Z} -gradation indices i):

$$\begin{aligned} \text{for } S(4) & \quad (\bar{4})_{-1} \oplus (15)_0 \oplus (\bar{20})_1 \oplus (\bar{10})_2 \\ \text{for } S(5) & \quad (\bar{5})_{-1} \oplus (24)_0 \oplus (\bar{45})_1 \oplus (\bar{40})_2 \oplus (\bar{15})_3 \\ \text{for } S(6) & \quad (\bar{6})_{-1} \oplus (35)_0 \oplus (\bar{84})_1 \oplus (\bar{105})_2 \oplus (\bar{70})_3 \oplus (\bar{21})_4 \end{aligned}$$

4.3 Cartan type superalgebras $H(n)$

The Cartan type Lie superalgebras $H(n)$ and $\tilde{H}(n)$, called Hamiltonian Lie superalgebras, are constructed as follows. Consider $\Omega(n)$ the associative superalgebra over $\Gamma(n)$ with generators denoted by $d\theta_1, \dots, d\theta_n$ and relations $d\theta_i \circ d\theta_j = d\theta_j \circ d\theta_i$. The \mathbb{Z}_2 -gradation is induced by setting $\deg d\theta_i = \bar{0}$. Any element of $\Omega(n)$ is written as

$$\omega_k = \sum_{i_1 \leq \dots \leq i_k} a_{i_1 \dots i_k} d\theta_{i_1} \circ \dots \circ d\theta_{i_k}$$

where $a_{i_1 \dots i_k} \in \Gamma(n)$.

Among them are the Hamiltonian forms defined by

$$\omega = \sum_{i,j=1}^n a_{ij} d\theta_i \circ d\theta_j$$

where $a_{ij} \in \Gamma(n)$, $a_{ij} = a_{ji}$ and $\det(a_{ij}(0)) \neq 0$. One defines then for each Hamiltonian form ω the Hamiltonian form superalgebra $\tilde{H}(\omega)$ as a $W(n)$ subsuperalgebra by

$$\tilde{H}(\omega) = \left\{ D \in W(n) \mid D(\omega) = 0 \right\}$$

and

$$H(\omega) = \left[\tilde{H}(\omega), \tilde{H}(\omega) \right]$$

Any element of $\tilde{H}(\omega)$ has the form

$$\sum_{i=1}^n P_i \frac{\partial}{\partial \theta_i} \quad \text{with} \quad \frac{\partial}{\partial \theta_j} \sum_{t=1}^n a_{it} P_t + \frac{\partial}{\partial \theta_i} \sum_{t=1}^n a_{jt} P_t = 0$$

One sets also

$$\begin{aligned} \tilde{H}(n) &= \tilde{H}\left((d\theta_1)^2 + \dots + (d\theta_n)^2\right) \\ H(n) &= \left[\tilde{H}(n), \tilde{H}(n) \right] \end{aligned}$$

The Lie superalgebra $H(n)$ has the following properties:

- $H(n)$ has dimension $2^n - 2$, the number of even generators being equal (resp. less by 2) to (than) the number of odd generators for n odd (resp. even).
- The superalgebra $H(n)$ is simple for $n \geq 4$.
- The semi-simple part of $\tilde{H}(n)_0$ is isomorphic to $so(n)$.
- The superalgebra $H(4)$ is isomorphic to $A(1, 1)$.
- The \mathbb{Z} -graded Lie superalgebras $H(n)$ and $\tilde{H}(n)$ are transitive ($\rightarrow \mathbb{Z}$ -graded superalgebras).
- Every automorphism of $H(n)$ with $n \geq 4$ and of $\tilde{H}(n)$ with $n \geq 3$ is induced by an automorphism of $\Gamma(n)$.
- The representation of $so(n)$ in the subspace $H(n)_i$ ($i = -1, 0, \dots, n-3$) is given by the antisymmetric tensor of rank $i+2$. For example we have (the subscripts stand for the \mathbb{Z} -gradation indices i):

$$\text{for } H(4) \quad (4)_{-1} \oplus (6)_0 \oplus (4)_1$$

$$\text{for } H(5) \quad (5)_{-1} \oplus (10)_0 \oplus (10)_1 \oplus (5)_2$$

$$\text{for } H(10) \quad (10)_{-1} \oplus (45)_0 \oplus (120)_1 \oplus (210)_2 \oplus (252)_3 \oplus (210)_4 \oplus (120)_5 \oplus (45)_6 \oplus (10)_7$$

For more details, see ref. [21].

5 Casimir invariants

The study of Casimir invariants plays a great role in the representation theory of simple Lie algebras since their eigenvalues on a finite dimensional highest weight irreducible

representation completely characterize this representation. In the case of Lie superalgebras, the situation is different. In fact, the eigenvalues of the Casimir invariants *do not* always characterize the finite dimensional highest weight irreducible representations of a Lie superalgebra. More precisely, their eigenvalues on a *typical* representation completely characterize this representation while they are identically vanishing on an *atypical* representation (\rightarrow Representations: typicality and atypicality).

Definition: Let $\mathcal{G} = \mathcal{G}_0 \oplus \mathcal{G}_1$ be a classical Lie superalgebra and $\mathcal{U}(\mathcal{G})$ its universal enveloping superalgebra (\rightarrow). An element $C \in \mathcal{U}(\mathcal{G})$ such that $\llbracket C, X \rrbracket = 0$ for all $X \in \mathcal{U}(\mathcal{G})$ is called a *Casimir element* of \mathcal{G} ($\llbracket \cdot, \cdot \rrbracket$ denotes the \mathbb{Z}_2 -graded commutator). The algebra of the Casimir elements of \mathcal{G} is the \mathbb{Z}_2 -center of $\mathcal{U}(\mathcal{G})$, denoted by $\mathcal{Z}(\mathcal{G})$. It is a (\mathbb{Z}_2 -graded) subalgebra of $\mathcal{U}(\mathcal{G})$.

Standard sequences of Casimir elements of the basic Lie superalgebras can be constructed as follows. Let $\mathcal{G} = sl(m|n)$ with $m \neq n$ or $osp(m|n)$ be a basic Lie superalgebra with non-degenerate bilinear form. Let $\{E_{IJ}\}$ be a matrix basis of generators of \mathcal{G} where $I, J = 1, \dots, m+n$ with $\deg I = 0$ for $1 \leq I \leq m$ and $\deg I = 1$ for $m+1 \leq I \leq m+n$. Then defining $(\bar{E}^0)_{IJ} = \delta_{IJ}$ and $(\bar{E}^{p+1})_{IJ} = (-1)^{\deg K} E_{IK}(\bar{E}^p)_{KJ}$, a standard sequence of Casimir operators is given by

$$C_p = \text{str}(\bar{E}^p) = (-1)^{\deg I} (\bar{E}^p)_{II} = E_{II_1} (-1)^{\deg I_1} \dots E_{I_k I_{k+1}} (-1)^{\deg I_{k+1}} \dots E_{I_{p-1} I}$$

Consider the $(m+n)^2$ elementary matrices e_{IJ} of order $m+n$ satisfying $(e_{IJ})_{KL} = \delta_{IL} \delta_{JK}$. In the case of $sl(m|n)$ with $m \neq n$, a basis $\{E_{IJ}\}$ is given by the matrices $E_{ij} = e_{ij} - \frac{1}{m} \delta_{ij} \sum_{q=1}^{q=m} e_{qq}$, $E_{kl} = e_{kl} - \frac{1}{n} \delta_{kl} \sum_{q=m+1}^{q=m+n} e_{qq}$ and $Y = \frac{1}{m-n} (n \sum_{q=1}^{q=m} e_{qq} + m \sum_{q=m+1}^{q=m+n} e_{qq})$, for the even part and $E_{ik} = e_{ik}$, $E_{kj} = e_{kj}$ for the odd part, where $1 \leq i, j \leq m$ and $m+1 \leq k, l \leq m+n$. One finds for example

$$\begin{aligned} C_1 &= 0 \\ C_2 &= E_{ij} E_{ji} - E_{kl} E_{lk} + E_{ki} E_{ik} - E_{ik} E_{ki} - \frac{m-n}{mn} Y^2 \end{aligned}$$

In the case of $osp(m|n)$, a basis $\{E_{IJ}\}$ is given $E_{IJ} = G_{IK} e_{KJ} + (-1)^{(1+\deg I)(1+\deg J)} G_{JK} e_{KI}$ where the matrix G_{IJ} is defined in "Orthosymplectic superalgebras" (\rightarrow). One finds for example

$$\begin{aligned} C_1 &= 0 \\ C_2 &= E_{ij} E_{ji} - E_{kl} E_{lk} + E_{ki} E_{ik} - E_{ik} E_{ki} \end{aligned}$$

where $1 \leq i, j \leq m$ and $m+1 \leq k, l \leq m+n$.

One has to stress that unlike the algebraic case, the center $\mathcal{Z}(\mathcal{G})$ for the classical Lie superalgebras is in general *not finitely generated*. More precisely, the only classical Lie superalgebras for which the center $\mathcal{Z}(\mathcal{G})$ is finitely generated are $osp(1|2n)$. In that case, $\mathcal{Z}(\mathcal{G})$ is generated by n Casimirs invariants of degree $2, 4, \dots, 2n$.

Example 1: Consider the superalgebra $sl(1|2)$ with generators $H, Z, E^+, E^-, F^+, F^-, \bar{F}^+, \bar{F}^-$ (\rightarrow Superalgebra $sl(1|2)$). Then one can prove that a generating system of the center $\mathcal{Z}(\mathcal{G})$ is given by, for $p \in \mathbb{N}$ and $H_{\pm} \equiv H \pm Z$:

$$\begin{aligned} C_{p+2} = & H_+ H_- Z^p + E^- E^+ (Z - \frac{1}{2})^p + \bar{F}^- F^+ (H_+ Z^p - (H_+ + 1)(Z + \frac{1}{2})^p) \\ & + F^- \bar{F}^+ ((H_- + 1)(Z - \frac{1}{2})^p - H_- Z^p) + (E^- \bar{F}^+ F^+ + \bar{F}^- F^- E^+) (Z^p - (Z - \frac{1}{2})^p) \\ & + \bar{F}^- F^- \bar{F}^+ F^+ ((Z + \frac{1}{2})^p + (Z - \frac{1}{2})^p - 2Z^p) \end{aligned}$$

In that case, the Casimir elements C_p satisfy the polynomial relations $C_p C_q = C_r C_s$ for $p + q = r + s$ where $p, q, r, s \geq 2$.

Example 2: Consider the superalgebra $osp(1|2)$ with generators H, E^+, E^-, F^+, F^- (\rightarrow Superalgebra $osp(1|2)$). In that case, the center $\mathcal{Z}(\mathcal{G})$ is finitely generated by

$$C_2 = H^2 + \frac{1}{2}(E^- E^+ + E^+ E^-) - (F^+ F^- - F^- F^+)$$

Moreover, there exists in the universal enveloping superalgebra \mathcal{U} of $osp(1|2)$ an *even* operator S which is a square root of the Casimir operator C_2 such that it commutes with the even generators and anticommutes with the odd ones, given by

$$S = 2(F^+ F^- - F^- F^+) + \frac{1}{4}$$

More precisely, it satisfies $S^2 = C_2 + \frac{1}{16}$.

Such an operator exists for any superalgebra of the type $osp(1|2n)$ [1].

Harish-Chandra homomorphism:

Consider a Borel decomposition $\mathcal{G} = \mathcal{N}^+ \oplus \mathcal{H} \oplus \mathcal{N}^-$ of \mathcal{G} (\rightarrow Simple root systems) where \mathcal{H} is a Cartan subalgebra of \mathcal{G} and set $\rho = \rho_0 - \rho_1$ where ρ_0 is the half-sum of positive even roots and ρ_1 the half-sum of positive odd roots. The universal enveloping superalgebra $\mathcal{U}(\mathcal{G})$ can be decomposed as follows:

$$\mathcal{U}(\mathcal{G}) = \mathcal{U}(\mathcal{H}) \oplus (\mathcal{N}^- \mathcal{U}(\mathcal{G}) + \mathcal{U}(\mathcal{G}) \mathcal{N}^+)$$

Then any element of the center $\mathcal{Z}(\mathcal{G})$ can be written as $z = z_0 + z'$ where $z_0 \in \mathcal{U}(\mathcal{H})$ and $z' \in \mathcal{N}^- \mathcal{U}(\mathcal{G}) + \mathcal{U}(\mathcal{G}) \mathcal{N}^+$. Let $S(\mathcal{H}) \subset \mathcal{U}(\mathcal{H})$ be the symmetric algebra over \mathcal{H} . Consider the projection $\bar{h}: \mathcal{Z}(\mathcal{G}) \rightarrow S(\mathcal{H})$, $z \mapsto z_0$ and γ the automorphism of $S(\mathcal{H})$ such that for all $H \in \mathcal{H}$ and $\lambda \in \mathcal{H}^*$, $\gamma(H(\lambda)) = H(\lambda - \rho)$. The mapping

$$h = \gamma \circ \bar{h}: \mathcal{Z}(\mathcal{G}) \rightarrow S(\mathcal{H}), z \mapsto \gamma(z_0)$$

is called the Harish–Chandra homomorphism [23, 24].

Property: Let $S(\mathcal{H})^W$ be the subset of elements of $S(\mathcal{H})$ invariant under the Weyl group of \mathcal{G} (\rightarrow). Then the image of $\mathcal{Z}(\mathcal{G})$ by the Harish–Chandra homomorphism is a subset of $S(\mathcal{H})^W$.

Example: Consider the Casimir elements C_p of $sl(1|2)$ given above. In the fermionic basis of $sl(1|2)$ (\rightarrow Simple root systems), the positive (resp. negative) root generators are E^+, F^+, \bar{F}^+ (resp. E^-, F^-, \bar{F}^-) and $\rho = 0$. It follows that the image of C_p by the Harish–Chandra homomorphism is given by

$$h(C_{p+2}) = H_+ H_- Z^p = 2^{-p} H_+ H_- (H_+ - H_-)^p$$

which is obviously invariant under the action of the Weyl group $H_+ \leftrightarrow -H_-$.

For more details, see refs. [13, 19, 36, 38].

6 Centralizer, Center, Normalizer of a Lie superalgebra

The definitions of the centralizer, the center, the normalizer of a Lie superalgebra follow those of a Lie algebra.

Definition: Let \mathcal{G} be a Lie superalgebra and \mathcal{S} a subset of elements in \mathcal{G} .

- The centralizer $\mathcal{C}_{\mathcal{G}}(\mathcal{S})$ is the subset of \mathcal{G} given by

$$\mathcal{C}_{\mathcal{G}}(\mathcal{S}) = \{X \in \mathcal{G} \mid \llbracket X, Y \rrbracket = 0, \forall Y \in \mathcal{S}\}$$

- The center $\mathcal{Z}(\mathcal{G})$ of \mathcal{G} is the set of elements of \mathcal{G} which commute with any element of \mathcal{G} (in other words, it is the centralizer of \mathcal{G} in \mathcal{G}):

$$\mathcal{Z}(\mathcal{G}) = \{X \in \mathcal{G} \mid \llbracket X, Y \rrbracket = 0, \forall Y \in \mathcal{G}\}$$

- The normalizer $\mathcal{N}_{\mathcal{G}}(\mathcal{S})$ is the subset of \mathcal{G} given by

$$\mathcal{N}_{\mathcal{G}}(\mathcal{S}) = \{X \in \mathcal{G} \mid \llbracket X, Y \rrbracket \in \mathcal{S}, \forall Y \in \mathcal{S}\}$$

7 Characters and supercharacters

Let \mathcal{G} be a basic Lie superalgebra with Cartan subalgebra \mathcal{H} . Consider $\mathcal{V}(\Lambda)$ a highest weight representation (\rightarrow) of \mathcal{G} with highest weight Λ , the weight decomposition of \mathcal{V} with respect to \mathcal{H} is

$$\mathcal{V}(\Lambda) = \bigoplus_{\lambda} \mathcal{V}_{\lambda} \quad \text{where} \quad \mathcal{V}_{\lambda} = \{\vec{v} \in \mathcal{V} \mid h(\vec{v}) = \lambda(h)\vec{v}, h \in \mathcal{H}\}$$

Let e^λ be the formal exponential, function on \mathcal{H}^* (dual of \mathcal{H}) such that $e^\lambda(\mu) = \delta_{\lambda,\mu}$ for two elements $\lambda, \mu \in \mathcal{H}^*$, which satisfies $e^\lambda e^\mu = e^{\lambda+\mu}$.

The *character* and *supercharacter* of $\mathcal{V}(\Lambda)$ are defined by

$$\begin{aligned}\text{ch } \mathcal{V}(\Lambda) &= \sum_{\lambda} (\dim \mathcal{V}_{\lambda}) e^{\lambda} \\ \text{sch } \mathcal{V}(\Lambda) &= \sum_{\lambda} (-1)^{\deg \lambda} (\dim \mathcal{V}_{\lambda}) e^{\lambda}\end{aligned}$$

Let $W(\mathcal{G})$ be the Weyl group (\rightarrow) of \mathcal{G} , Δ the root system of \mathcal{G} , Δ_0^+ the set of positive even roots, Δ_1^+ the set of positive odd roots, $\overline{\Delta}_0^+$ the subset of roots $\alpha \in \Delta_0^+$ such that $\alpha/2 \notin \Delta_1^+$. We set for an element $w \in W(\mathcal{G})$, $\varepsilon(w) = (-1)^{\ell(w)}$ and $\varepsilon'(w) = (-1)^{\ell'(w)}$ where $\ell(w)$ is the number of reflections in the expression of $w \in W(\mathcal{G})$ and $\ell'(w)$ is the number of reflections with respect to the roots of $\overline{\Delta}_0^+$ in the expression of $w \in W(\mathcal{G})$. We denote by ρ_0 and ρ_1 the half-sums of positive even roots and positive odd roots, and $\rho = \rho_0 - \rho_1$. The characters and supercharacters of the *typical* finite dimensional representations $\mathcal{V}(\Lambda)$ (\rightarrow) of the basic Lie superalgebras are given by

$$\begin{aligned}\text{ch } \mathcal{V}(\Lambda) &= L^{-1} \sum_w \varepsilon(w) e^{w(\Lambda+\rho)} \\ \text{sch } \mathcal{V}(\Lambda) &= L'^{-1} \sum_w \varepsilon'(w) e^{w(\Lambda+\rho)}\end{aligned}$$

where

$$L = \frac{\prod_{\alpha \in \Delta_0^+} (e^{\alpha/2} - e^{-\alpha/2})}{\prod_{\alpha \in \Delta_1^+} (e^{\alpha/2} + e^{-\alpha/2})} \quad \text{and} \quad L' = \frac{\prod_{\alpha \in \Delta_0^+} (e^{\alpha/2} - e^{-\alpha/2})}{\prod_{\alpha \in \Delta_1^+} (e^{\alpha/2} - e^{-\alpha/2})}$$

In the case of the superalgebra $B(0, n)$ all the representations are typical. One finds then explicitly

$$\begin{aligned}\text{ch } \mathcal{V}(\Lambda) &= \frac{\sum_w \varepsilon(w) e^{w(\Lambda+\rho)}}{\sum_w \varepsilon(w) e^{w(\rho)}} \\ \text{sch } \mathcal{V}(\Lambda) &= \frac{\sum_w \varepsilon'(w) e^{w(\Lambda+\rho)}}{\sum_w \varepsilon'(w) e^{w(\rho)}}\end{aligned}$$

In the case of the superalgebra $A(m, n)$, the character of the typical representation $\mathcal{V}(\Lambda)$ is given by

$$\text{ch } \mathcal{V}(\Lambda) = \frac{1}{L_0} \sum_w \varepsilon(w) w \left(e^{\Lambda+\rho_0} \prod_{\beta \in \Delta_1^+} (1 + e^{-\beta}) \right)$$

and the character of the singly atypical representation by (see ref. [49])

$$\text{ch } \mathcal{V}(\Lambda) = \frac{1}{L_0} \sum_w \varepsilon(w) w \left(e^{\Lambda+\rho_0} \prod_{\beta \in \Delta_1^+, \langle \Lambda+\rho | \beta \rangle \neq 0} (1 + e^{-\beta}) \right)$$

where L_0 is defined as

$$\prod_{\alpha \in \Delta_0^+} (e^{\alpha/2} - e^{-\alpha/2})$$

In the case of the superalgebra $C(n+1)$, the highest weight irreducible representations are either typical or singly atypical. It follows that the character formulae of the typical and atypical representations of $C(n+1)$ are the same as for $A(m, n)$ above (with the symbols being those of $C(n+1)$).

→ Representations: highest weight, induced modules, typical and atypical.
For more details, see refs. [23, 49].

8 Classical Lie superalgebras

Definition: A simple Lie superalgebra $\mathcal{G} = \mathcal{G}_0 \oplus \mathcal{G}_1$ is called *classical* if the representation of the even subalgebra \mathcal{G}_0 on the odd part \mathcal{G}_1 is completely reducible.

Theorem: A simple Lie superalgebra \mathcal{G} is classical if and only if its even part \mathcal{G}_0 is a reductive Lie algebra.

Let $\mathcal{G} = \mathcal{G}_0 \oplus \mathcal{G}_1$ be a classical Lie superalgebra. Then the representation of \mathcal{G}_0 on \mathcal{G}_1 is either (i) irreducible or (ii) the direct sum of two irreducible representations of \mathcal{G}_0 . In that case, one has (see below)

$$\mathcal{G}_1 = \mathcal{G}_{-1} \oplus \mathcal{G}_1$$

with

$$\{\mathcal{G}_{-1}, \mathcal{G}_1\} = \mathcal{G}_0 \quad \text{and} \quad \{\mathcal{G}_1, \mathcal{G}_1\} = \{\mathcal{G}_{-1}, \mathcal{G}_{-1}\} = 0$$

In the case (i), the superalgebra is said of the type I and in the case (ii) of the type II.

Theorem: Let $\mathcal{G} = \mathcal{G}_0 \oplus \mathcal{G}_1$ be a classical Lie superalgebra. Then there exists a consistent \mathbb{Z} -gradation $\mathcal{G} = \bigoplus_{i \in \mathbb{Z}} \mathcal{G}_i$ of \mathcal{G} (called the distinguished \mathbb{Z} -gradation) such that
- for the superalgebras of type I, $\mathcal{G}_i = 0$ for $|i| > 1$ and $\mathcal{G}_0 = \mathcal{G}_0$, $\mathcal{G}_1 = \mathcal{G}_{-1} \oplus \mathcal{G}_1$.
- for the superalgebras of type II, $\mathcal{G}_i = 0$ for $|i| > 2$ and $\mathcal{G}_0 = \mathcal{G}_{-2} \oplus \mathcal{G}_0 \oplus \mathcal{G}_2$, $\mathcal{G}_1 = \mathcal{G}_{-1} \oplus \mathcal{G}_1$.

Definition: A classical Lie superalgebra \mathcal{G} is called *basic* if there exists a non-degenerate invariant bilinear form on \mathcal{G} (→ Killing form). The classical Lie superalgebras which are not basic are called *strange*.

The Table II resumes the classification and the Table III gives the \mathcal{G}_0 and \mathcal{G}_1 structure of the classical Lie superalgebras.

→ Exceptional Lie superalgebras, Orthosymplectic superalgebras, Strange superalgebras, Unitary superalgebras.

| | type I | type II |
|---|---|--|
| BASIC (non-degenerate Killing form) | $A(m, n) \quad m > n \geq 0$ $C(n+1) \quad n \geq 1$ $F(4)$ $G(3)$ | $B(m, n) \quad m \geq 0, n \geq 1$ $D(m, n) \quad \begin{cases} m \geq 2, n \geq 1 \\ m \neq n+1 \end{cases}$ |
| BASIC (zero Killing form) | $A(n, n) \quad n \geq 1$ | $D(n+1, n) \quad n \geq 1$ $D(2, 1; \alpha) \quad \alpha \in \mathbb{C} \setminus \{0, -1\}$ |
| STRANGE | $P(n) \quad n \geq 2$ | $Q(n) \quad n \geq 2$ |

Table II: Classical Lie superalgebras.

| superalgebra \mathcal{G} | $\mathcal{G}_{\bar{0}}$ | $\mathcal{G}_{\bar{1}}$ |
|----------------------------|------------------------------|------------------------------------|
| $A(m, n)$ | $A_m \oplus A_n \oplus U(1)$ | $(\bar{m}, n) \oplus (m, \bar{n})$ |
| $A(n, n)$ | $A_n \oplus A_n$ | $(\bar{n}, n) \oplus (n, \bar{n})$ |
| $C(n+1)$ | $C_n \oplus U(1)$ | $(2n) \oplus (2n)$ |
| $B(m, n)$ | $B_m \oplus C_n$ | $(2m+1, 2n)$ |
| $D(m, n)$ | $D_m \oplus C_n$ | $(2m, 2n)$ |
| $F(4)$ | $A_1 \oplus B_3$ | $(2, 8)$ |
| $G(3)$ | $A_1 \oplus G_2$ | $(2, 7)$ |
| $D(2, 1; \alpha)$ | $A_1 \oplus A_1 \oplus A_1$ | $(2, 2, 2)$ |
| $P(n)$ | A_n | $[2] \oplus [1^{n-1}]$ |
| $Q(n)$ | A_n | $\text{ad}(A_n)$ |

Table III: $\mathcal{G}_{\bar{0}}$ and $\mathcal{G}_{\bar{1}}$ structure of the classical Lie superalgebras.

9 Classification of simple Lie superalgebras

Among Lie superalgebras appearing in the classification of simple Lie superalgebras, one distinguishes two general families: the classical Lie superalgebras in which the representation of the even subalgebra on the odd part is completely reducible and the Cartan type superalgebras in which such a property is no more valid. Among the classical superalgebras (\rightarrow), one naturally separates the basic series from the strange ones.

The basic (or contragredient) Lie superalgebras split into four infinite families denoted by $A(m, n)$ or $sl(m+1|n+1)$ for $m \neq n$ and $A(n, n)$ or $sl(n+1|n+1)/\mathcal{Z}$ where \mathcal{Z} is a one-dimensional center for $m = n$ (unitary series), $B(m, n)$ or $osp(2m+1|2n)$, $C(n)$ or $osp(2|2n)$, $D(m, n)$ or $osp(2m|2n)$ (orthosymplectic series) and three exceptional superalgebras $F(4)$, $G(3)$ and $D(2, 1; \alpha)$, the last one being actually a one-parameter family of superalgebras. Two infinite families denoted by $P(n)$ and $Q(n)$ constitute the strange (or non-contragredient) superalgebras.

The Cartan type superalgebras (\rightarrow) are classified into four infinite families, $W(n)$, $S(n)$, $\tilde{S}(n)$ and $H(n)$.

The following scheme resumes this classification:

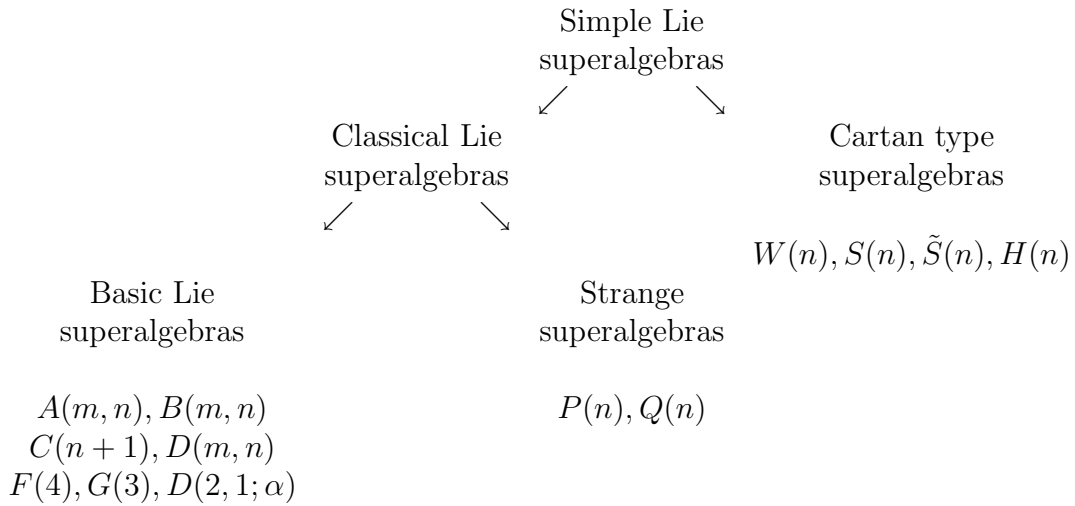

\rightarrow Cartan type superalgebras, Classical Lie superalgebras.

For more details, see refs. [21, 22, 29].

10 Clifford algebras

Let $\{\gamma_i\}$ ($i = 1, \dots, n$) be a set of square matrices such that

$$\{\gamma_i, \gamma_j\} = \gamma_i \gamma_j + \gamma_j \gamma_i = 2\delta_{ij} \mathbb{I}$$

where \mathbb{I} is the unit matrix. The algebra spanned by the n matrices γ_i is called the Clifford algebra. These relations can be satisfied by matrices of order 2^p when $n = 2p$ or $n = 2p+1$.

Consider the 2×2 Pauli matrices $\sigma_1, \sigma_2, \sigma_3$:

$$\sigma_1 = \begin{pmatrix} 0 & 1 \\ 1 & 0 \end{pmatrix} \quad \sigma_2 = \begin{pmatrix} 0 & -i \\ i & 0 \end{pmatrix} \quad \sigma_3 = \begin{pmatrix} 1 & 0 \\ 0 & -1 \end{pmatrix}$$

Then the matrices γ_i can be expressed in terms of a p -fold tensor product of the Pauli matrices.

Property: There exists a representation such that

- i) if n is even, the matrices γ_i are hermitian, half of them being symmetric, half of them being antisymmetric.
- ii) if n is odd, the matrices γ_i with $i = 1, \dots, 2p$ are hermitian, half of them being symmetric, half of them being antisymmetric and the matrix γ_{2p+1} is diagonal.

In this representation, the matrices γ can be written as ($i = 1, \dots, p-1$)

$$\begin{aligned} \gamma_1 &= \sigma_1^{(1)} \otimes \dots \otimes \sigma_1^{(p)} \\ \gamma_{2i} &= \sigma_1^{(1)} \otimes \dots \otimes \sigma_1^{(p-i)} \otimes \sigma_2^{(p-i+1)} \otimes \mathbb{I}^{(p-i+2)} \otimes \dots \otimes \mathbb{I}^{(p)} \\ \gamma_{2i+1} &= \sigma_1^{(1)} \otimes \dots \otimes \sigma_1^{(p-i)} \otimes \sigma_3^{(p-i+1)} \otimes \mathbb{I}^{(p-i+2)} \otimes \dots \otimes \mathbb{I}^{(p)} \\ \gamma_{2p} &= \sigma_2^{(1)} \otimes \mathbb{I}^{(2)} \otimes \dots \otimes \mathbb{I}^{(p)} \\ \gamma_{2p+1} &= \sigma_3^{(1)} \otimes \mathbb{I}^{(2)} \otimes \dots \otimes \mathbb{I}^{(p)} \end{aligned}$$

One can check that with this representation, one has ($i = 1, \dots, p$)

$$\gamma_{2i}^t = -\gamma_{2i} \quad \text{and} \quad \gamma_{2i+1}^t = \gamma_{2i+1}, \gamma_{2p+1}^t = \gamma_{2p+1}$$

Definition: The matrix $C = \prod_{i=1}^p \gamma_{2i-1}$ for $n = 2p$ and $C = \prod_{i=1}^{p+1} \gamma_{2i-1}$ for $n = 2p+1$ is called the charge conjugation matrix.

Property: The charge conjugation matrix satisfies

- $C^t C = 1$
- for $n = 2p$

$$C^t = (-1)^{p(p-1)/2} C = \begin{cases} C & \text{for } p = 0, 1 \pmod{4} \\ -C & \text{for } p = 2, 3 \pmod{4} \end{cases}$$

$$C \gamma_i = (-1)^{p+1} \gamma_i^t C \quad (i = 1, \dots, 2p)$$
- for $n = 2p+1$

$$C^t = (-1)^{p(p+1)/2} C = \begin{cases} C & \text{for } p = 0, 3 \pmod{4} \\ -C & \text{for } p = 1, 2 \pmod{4} \end{cases}$$

$$C \gamma_i = (-1)^p \gamma_i^t C \quad (i = 1, \dots, 2p+1)$$

11 Decompositions w.r.t. $osp(1|2)$ subalgebras

The method for finding the decompositions of the fundamental and the adjoint representations of the basic Lie superalgebras with respect to their different $osp(1|2)$ subalgebras is the following:

- one considers an $osp(1|2)$ embedding in a basic Lie superalgebra $\mathcal{G} = \mathcal{G}_0 \oplus \mathcal{G}_1$, determined by a certain subalgebra \mathcal{K} in \mathcal{G} (\rightarrow Embeddings of $osp(1|2)$), which is expressed as a direct sum of simple components: $\mathcal{K} = \oplus_i \mathcal{K}_i$.
- to each couple $(\mathcal{G}, \mathcal{K}_i)$ one associates $osp(1|2)$ representations given in Tables 17 (regular embeddings) and 18 (singular embeddings); the notations \mathcal{R} and \mathcal{R}'' are explained below.
- the decomposition of the fundamental representation of \mathcal{G} with respect to the $osp(1|2)$ subalgebra under consideration is then given by a direct sum of $osp(1|2)$ representations.
- starting from a decomposition of the fundamental representation of \mathcal{G} of the form

$$\text{fund}_{\mathcal{K}} \mathcal{G} = \left(\oplus_i \mathcal{R}_{j_i} \right) \oplus \left(\oplus_k \mathcal{R}''_{j_k} \right)$$

the decomposition of the adjoint representation $\text{ad}_{\mathcal{K}} \mathcal{G}$ is given in the unitary series by

$$\begin{aligned} \text{ad}_{\mathcal{K}} \mathcal{G} &= \left(\oplus_i \mathcal{R}_{j_i} \oplus_k \mathcal{R}''_{j_k} \right) \otimes \left(\oplus_i \mathcal{R}_{j_i} \oplus_k \mathcal{R}''_{j_k} \right) - \mathcal{R}_0 && \text{for } sl(m|n), m \neq n \\ \text{ad}_{\mathcal{K}} \mathcal{G} &= \left(\oplus_i \mathcal{R}_{j_i} \oplus_k \mathcal{R}''_{j_k} \right) \otimes \left(\oplus_i \mathcal{R}_{j_i} \oplus_k \mathcal{R}''_{j_k} \right) - 2\mathcal{R}_0 && \text{for } sl(n|n) \end{aligned}$$

and in the orthosymplectic series by

$$\text{ad}_{\mathcal{K}} \mathcal{G} = \left(\oplus_i \mathcal{R}_{j_i} \right) \otimes \left(\oplus_i \mathcal{R}_{j_i} \right) \Big|_A \oplus \left(\oplus_k \mathcal{R}''_{j_k} \right) \otimes \left(\oplus_k \mathcal{R}''_{j_k} \right) \Big|_S \oplus \left(\oplus_i \mathcal{R}_{j_i} \right) \otimes \left(\oplus_k \mathcal{R}''_{j_k} \right)$$

The symmetrized and antisymmetrized products of $osp(1|2)$ representations \mathcal{R}_j are expressed, with analogy with the Lie algebra case, by (in the following formulae j and q are integer)

$$\begin{aligned} \mathcal{R}_j \otimes \mathcal{R}_j \Big|_A &= \bigoplus_{q=1}^j \left(\mathcal{R}_{2q-1} \oplus \mathcal{R}_{2q-1/2} \right) \\ \mathcal{R}_j \otimes \mathcal{R}_j \Big|_S &= \bigoplus_{q=0}^{j-1} \left(\mathcal{R}_{2q} \oplus \mathcal{R}_{2q+1/2} \right) \oplus \mathcal{R}_{2j} \\ \mathcal{R}_{j-1/2} \otimes \mathcal{R}_{j-1/2} \Big|_A &= \bigoplus_{q=0}^{j-1} \left(\mathcal{R}_{2q} \oplus \mathcal{R}_{2q+1/2} \right) \\ \mathcal{R}_{j-1/2} \otimes \mathcal{R}_{j-1/2} \Big|_S &= \bigoplus_{q=1}^{j-1} \left(\mathcal{R}_{2q-1} \oplus \mathcal{R}_{2q-1/2} \right) \oplus \mathcal{R}_{2j-1} \end{aligned}$$

together with (for j, k integer or half-integer)

$$\begin{aligned} \left((\mathcal{R}_j \oplus \mathcal{R}_k) \otimes (\mathcal{R}_j \oplus \mathcal{R}_k) \right) \Big|_A &= \left(\mathcal{R}_j \otimes \mathcal{R}_j \right) \Big|_A \oplus \left(\mathcal{R}_k \otimes \mathcal{R}_k \right) \Big|_A \oplus (\mathcal{R}_j \oplus \mathcal{R}_k) \\ \left((\mathcal{R}_j \oplus \mathcal{R}_k) \otimes (\mathcal{R}_j \oplus \mathcal{R}_k) \right) \Big|_S &= \left(\mathcal{R}_j \otimes \mathcal{R}_j \right) \Big|_S \oplus \left(\mathcal{R}_k \otimes \mathcal{R}_k \right) \Big|_S \oplus (\mathcal{R}_j \oplus \mathcal{R}_k) \end{aligned}$$

and (n integer)

$$\begin{aligned} (n\mathcal{R}_j \otimes n\mathcal{R}_j)|_A &= \frac{n(n+1)}{2}(\mathcal{R}_j \otimes \mathcal{R}_j)|_A \oplus \frac{n(n-1)}{2}(\mathcal{R}_j \otimes \mathcal{R}_j)|_S \\ (n\mathcal{R}_j \otimes n\mathcal{R}_j)|_S &= \frac{n(n+1)}{2}(\mathcal{R}_j \otimes \mathcal{R}_j)|_S \oplus \frac{n(n-1)}{2}(\mathcal{R}_j \otimes \mathcal{R}_j)|_A \end{aligned}$$

The same formulae also hold for the \mathcal{R}'' representations.

Let us stress that one has to introduce here two different notations for the $osp(1|2)$ representations which enter in the decomposition of the fundamental representation of \mathcal{G} , depending on the origin of the two factors \mathcal{D}_j and $\mathcal{D}_{j-1/2}$ of a representation \mathcal{R}_j (let us recall that an $osp(1|2)$ representation \mathcal{R}_j decomposes under the $sl(2)$ part as $\mathcal{R}_j = \mathcal{D}_j \oplus \mathcal{D}_{j-1/2}$). For $\mathcal{G} = sl(m|n)$ (resp. $\mathcal{G} = osp(m|n)$), an $osp(1|2)$ representation is denoted \mathcal{R}_j if the representation \mathcal{D}_j comes from the decomposition of the fundamental of $sl(m)$ (resp. $so(m)$), and \mathcal{R}'_j if the representation \mathcal{D}_j comes from the decomposition of the fundamental of $sl(n)$ (resp. $sp(n)$).

In the same way, considering the tensor products of \mathcal{R} and \mathcal{R}'' representations given above, one has to distinguish the $osp(1|2)$ representations in the decomposition of the adjoint representations: the \mathcal{R}_j representations are such that the \mathcal{D}_j comes from the decomposition of the even part \mathcal{G}_0 for j integer or of the odd part \mathcal{G}_1 for j half-integer and the \mathcal{R}'_j representations are such that \mathcal{D}_j comes from the decomposition of the even part \mathcal{G}_0 for j half-integer or of the odd part \mathcal{G}_1 for j integer.

Finally, the products between unprimed and primed representations obey the following rules

$$\begin{aligned} \mathcal{R}_{j_1} \otimes \mathcal{R}_{j_2} &= \begin{cases} \oplus \mathcal{R}_{j_3} & \text{if } j_1 + j_2 \text{ is integer} \\ \oplus \mathcal{R}'_{j_3} & \text{if } j_1 + j_2 \text{ is half-integer} \end{cases} \\ \mathcal{R}''_{j_1} \otimes \mathcal{R}''_{j_2} &= \begin{cases} \oplus \mathcal{R}_{j_3} & \text{if } j_1 + j_2 \text{ is integer} \\ \oplus \mathcal{R}'_{j_3} & \text{if } j_1 + j_2 \text{ is half-integer} \end{cases} \\ \mathcal{R}_{j_1} \otimes \mathcal{R}''_{j_2} &= \begin{cases} \oplus \mathcal{R}'_{j_3} & \text{if } j_1 + j_2 \text{ is integer} \\ \oplus \mathcal{R}_{j_3} & \text{if } j_1 + j_2 \text{ is half-integer} \end{cases} \end{aligned}$$

The tables 17 to 28 give the different decompositions of the fundamental and adjoint representations of the basic Lie superalgebras with respect to the different $osp(1|2)$ embeddings. For more details, see ref. [9].

12 Decompositions w.r.t. $sl(1|2)$ subalgebras

The method for finding the decompositions of the fundamental and the adjoint representations of the basic Lie superalgebras with respect to their different $sl(1|2)$ subalgebras is the following:

- one considers a $sl(1|2)$ embedding in a basic Lie superalgebra $\mathcal{G} = \mathcal{G}_0 \oplus \mathcal{G}_1$, determined by a certain sub-superalgebra \mathcal{K} in \mathcal{G} (\rightarrow Embeddings of $sl(1|2)$), which is expressed as a direct sum of simple components: $\mathcal{K} = \oplus_i \mathcal{K}_i$.
- to each couple $(\mathcal{G}, \mathcal{K}_i)$ one associates (atypical) $sl(1|2)$ representations $\pi(\pm j_i, j_i) \equiv \pi_{\pm}(j_i)$ or $osp(2|2)$ representations $\pi(0, \frac{1}{2})$ (\rightarrow Superalgebra $sl(1|2)$) given in the following table:

| \mathcal{G} | \mathcal{K} | fund $_{\mathcal{K}} \mathcal{G}$ |
|---------------|---------------|--|
| $sl(m n)$ | $sl(p+1 p)$ | $\pi_+(\frac{p}{2})$ |
| | $sl(p p+1)$ | $\pi'_+(\frac{p}{2})$ |
| $osp(m 2n)$ | $sl(p+1 p)$ | $\pi_+(\frac{p}{2}) \oplus \pi_-(\frac{p}{2})$ |
| | $sl(p p+1)$ | $\pi'_+(\frac{p}{2}) \oplus \pi'_-(\frac{p}{2})$ |
| | $osp(2 2)$ | $\pi''(0, \frac{1}{2})$ |

(The notation π or π'' is just to distinguish the superalgebras $sl(p+1|p)$ or $sl(p|p+1)$ they come from. This will be used below).

In the case of $sl(m|n)$, one could also use π_- and π''_- representations as well, leading to different but equivalent decompositions of the adjoint representation of \mathcal{G} . This fact is related to the existence of non-trivial outer automorphisms for $sl(1|2)$.

- the decomposition of the fundamental representation of \mathcal{G} with respect to the $sl(1|2)$ subalgebra under consideration is then given by a direct sum of $sl(1|2)$ representations of the above type, eventually completed by trivial representations.
- starting from a decomposition of the fundamental representation of \mathcal{G} of the form

$$\text{fund}_{\mathcal{K}} \mathcal{G} = \left(\oplus_i \pi_{\pm}(j_i) \right) \oplus \left(\oplus_k \pi''_{\pm}(j_k) \right)$$

the decomposition of the adjoint representation $\text{ad}_{\mathcal{K}} \mathcal{G}$ is given in the unitary series by

$$\begin{aligned} \text{ad}_{\mathcal{K}} \mathcal{G} &= \left(\oplus_i \pi_{\pm}(j_i) \oplus \oplus_k \pi''_{\pm}(j_k) \right)^2 - \pi(0, 0) && \text{for } A(m|n), m \neq n \\ \text{ad}_{\mathcal{K}} \mathcal{G} &= \left(\oplus_i \pi_{\pm}(j_i) \oplus \oplus_k \pi''_{\pm}(j_k) \right)^2 - 2\pi(0, 0) && \text{for } A(n|n) \end{aligned}$$

and in the orthosymplectic series by

$$\text{ad}_{\mathcal{K}} \mathcal{G} = \left(\oplus_i \pi_{\pm}(j_i) \right)^2 \Big|_A \oplus \left(\oplus_k \pi''_{\pm}(j_k) \right)^2 \Big|_S \oplus \left(\oplus_i \pi_{\pm}(j_i) \oplus \oplus_k \pi''_{\pm}(j_k) \right)$$

The symmetrized and antisymmetrized products of atypical $sl(1|2)$ representations are given by

$$\begin{aligned} \left(\pi_{\pm}(j) \oplus \pi_{\pm}(k) \right)^2 \Big|_A &= \left(\pi_{\pm}(j) \otimes \pi_{\pm}(j) \right)^2 \Big|_A \oplus \left(\pi_{\pm}(k) \otimes \pi_{\pm}(k) \right)^2 \Big|_A \oplus \left(\pi_{\pm}(j) \otimes \pi_{\pm}(k) \right) \\ \left(\pi_{\pm}(j) \oplus \pi_{\pm}(k) \right)^2 \Big|_S &= \left(\pi_{\pm}(j) \otimes \pi_{\pm}(j) \right)^2 \Big|_S \oplus \left(\pi_{\pm}(k) \otimes \pi_{\pm}(k) \right)^2 \Big|_S \oplus \left(\pi_{\pm}(j) \otimes \pi_{\pm}(k) \right) \end{aligned}$$

and (n integer)

$$\begin{aligned} (n\pi_{\pm}(j) \otimes n\pi_{\pm}(j))\Big|_A &= \frac{n(n+1)}{2} (\pi_{\pm}(j) \otimes \pi_{\pm}(j))\Big|_A \oplus \frac{n(n-1)}{2} (\pi_{\pm}(j) \otimes \pi_{\pm}(j))\Big|_S \\ (n\pi_{\pm}(j) \otimes n\pi_{\pm}(j))\Big|_S &= \frac{n(n+1)}{2} (\pi_{\pm}(j) \oplus \pi_{\pm}(j))\Big|_S \oplus \frac{n(n-1)}{2} (\pi_{\pm}(j) \otimes \pi_{\pm}(j))\Big|_A \end{aligned}$$

where (in the following formulae j and q are integer)

$$\begin{aligned} (\pi_+(j) \oplus \pi_-(j))^2\Big|_A &= \bigoplus_{q=0}^{2j} \pi(0, q) \oplus \bigoplus_{q=1}^j \pi(2j + \frac{1}{2}, 2q - \frac{1}{2}) \oplus \bigoplus_{q=1}^j \pi(-2j - \frac{1}{2}, 2q - \frac{1}{2}) \\ (\pi_+(j) \oplus \pi_-(j))^2\Big|_S &= \bigoplus_{q=0}^{2j} \pi(0, q) \oplus \bigoplus_{q=0}^{j-1} \pi(2j + \frac{1}{2}, 2q + \frac{1}{2}) \oplus \bigoplus_{q=0}^j \pi(-2j - \frac{1}{2}, 2q + \frac{1}{2}) \\ &\quad \oplus \pi_+(2j) \oplus \pi_-(2j) \\ (\pi_+(j + \frac{1}{2}) \oplus \pi_-(j + \frac{1}{2}))^2\Big|_A &= \bigoplus_{q=0}^{2j+1} \pi(0, q) \oplus \bigoplus_{q=0}^j \pi(2j + \frac{3}{2}, 2q + \frac{1}{2}) \\ &\quad \oplus \bigoplus_{q=0}^j \pi(-2j - \frac{3}{2}, 2q + \frac{1}{2}) \\ (\pi_+(j + \frac{1}{2}) \oplus \pi_-(j + \frac{1}{2}))^2\Big|_S &= \bigoplus_{q=0}^{2j+1} \pi(0, q) \oplus \bigoplus_{q=1}^j \pi(2j + \frac{3}{2}, 2q - \frac{1}{2}) \\ &\quad \oplus \bigoplus_{q=1}^j \pi(-2j - \frac{3}{2}, 2q - \frac{1}{2}) \oplus \pi_+(2j+1) \oplus \pi_-(2j+1) \end{aligned}$$

Finally, in the case of $osp(2|2)$ embeddings, the product of the $\pi(0, \frac{1}{2})$ representation by itself is not fully reducible but gives rise to the indecomposable $sl(1|2)$ representation of the type $\pi(0; -\frac{1}{2}, \frac{1}{2}; 0)$ (\rightarrow Superalgebra $sl(1|2)$).

Considering the tensor products of π and π'' representations given above, one has to distinguish the $sl(1|2)$ representations in the decomposition of the adjoint representations. Let us recall that a $sl(1|2)$ representation $\pi(b, j)$ decomposes under the $sl(2) \oplus U(1)$ part as $\pi(b, j) = D_j(b) \oplus D_{j-1/2}(b - 1/2) \oplus D_{j-1/2}(b + 1/2) \oplus D_{j-1}(b)$ and $\pi_{\pm}(j) = D_j(\pm j) \oplus D_{j-1/2}(\pm j \pm 1/2)$. The $\pi(b, j)$ representations are such that the \mathcal{D}_j comes from the decomposition of the even part $\mathcal{G}_{\bar{0}}$ for j integer or of the odd part $\mathcal{G}_{\bar{1}}$ for j half-integer and the $\pi'(b, j)$ representations are such that \mathcal{D}_j comes from the decomposition of the even part $\mathcal{G}_{\bar{0}}$ for j half-integer or of the odd part $\mathcal{G}_{\bar{1}}$ for j integer. Finally, the products between unprimed and primed representations obey the following rules

$$\begin{aligned} \pi(b_1, j_1) \otimes \pi(b_2, j_2) &= \begin{cases} \bigoplus \pi(b_3, j_3) & \text{if } j_1 + j_2 \text{ is integer} \\ \bigoplus \pi'(b_3, j_3) & \text{if } j_1 + j_2 \text{ is half-integer} \end{cases} \\ \pi''(b_1, j_1) \otimes \pi''(b_2, j_2) &= \begin{cases} \bigoplus \pi(b_3, j_3) & \text{if } j_1 + j_2 \text{ is integer} \\ \bigoplus \pi'(b_3, j_3) & \text{if } j_1 + j_2 \text{ is half-integer} \end{cases} \\ \pi(b_1, j_1) \otimes \pi''(b_2, j_2) &= \begin{cases} \bigoplus \pi'(b_3, j_3) & \text{if } j_1 + j_2 \text{ is integer} \\ \bigoplus \pi(b_3, j_3) & \text{if } j_1 + j_2 \text{ is half-integer} \end{cases} \end{aligned}$$

The tables 29 to 34 give the different decompositions of the fundamental and adjoint representations of the basic Lie superalgebras with respect to the different $sl(1|2)$ embeddings. For more details, see ref. [33].

13 Derivation of a Lie superalgebra

Definition: Let $\mathcal{G} = \mathcal{G}_{\bar{0}} \oplus \mathcal{G}_{\bar{1}}$ be a Lie superalgebra. A *derivation* D of degree $\deg D \in \mathbb{Z}_2$ of the superalgebra \mathcal{G} is an endomorphism of \mathcal{G} such that

$$D \llbracket X, Y \rrbracket = \llbracket D(X), Y \rrbracket + (-1)^{\deg D \cdot \deg X} \llbracket X, D(Y) \rrbracket$$

If $\deg D = \bar{0}$, the derivation is even, otherwise $\deg D = \bar{1}$ and the derivation is odd.

The space of all the derivations of \mathcal{G} is denoted by $\text{Der } \mathcal{G} = \text{Der}_{\bar{0}} \mathcal{G} \oplus \text{Der}_{\bar{1}} \mathcal{G}$.

If D and D' are two derivations of \mathcal{G} , then $\llbracket D, D' \rrbracket \in \text{Der } \mathcal{G}$, that is the space $\text{Der } \mathcal{G}$ closes under the Lie superbracket.

The space $\text{Der } \mathcal{G}$ is called the superalgebra of derivations of \mathcal{G} . In particular,

$$\text{ad}_X : Y \mapsto \text{ad}_X(Y) = \llbracket X, Y \rrbracket$$

is a derivation of \mathcal{G} . These derivations are called inner derivations of \mathcal{G} . They form an ideal $\text{InDer } \mathcal{G}$ of $\text{Der } \mathcal{G}$. Every derivation of a simple Lie superalgebra with non-degenerate Killing form is inner.

14 Dirac matrices

→ Clifford algebra, Spinors (in the Lorentz group), Supersymmetry algebra, Superconformal algebra.

15 Dynkin diagrams

Let \mathcal{G} be a basic Lie superalgebra of rank r and dimension n with Cartan subalgebra \mathcal{H} . Let $\Delta^0 = (\alpha_1, \dots, \alpha_r)$ be a simple root system (\rightarrow) of \mathcal{G} and $A^s = (a'_{ij})$ be the corresponding *symmetric* Cartan matrix (\rightarrow), defined by $a'_{ij} = (\alpha_i, \alpha_j)$. One can associate to Δ^0 a Dynkin diagram according to the following rules:

1. one associates to each simple even root a white dot, to each simple odd root of non-zero length ($a'_{ii} \neq 0$) a black dot and to each simple odd root of zero length ($a'_{ii} = 0$) a grey dot.
2. the i th and j th dots will be joined by η_{ij} lines where

$$\begin{aligned} \eta_{ij} &= \frac{2|a'_{ij}|}{\min(|a'_{ii}|, |a'_{jj}|)} && \text{if } a'_{ii} \cdot a'_{jj} \neq 0 \\ \eta_{ij} &= \frac{2|a'_{ij}|}{\min_{a'_{kk} \neq 0} |a'_{kk}|} && \text{if } a'_{ii} \neq 0 \text{ and } a'_{jj} = 0 \\ \eta_{ij} &= |a'_{ij}| && \text{if } a'_{ii} = a'_{jj} = 0 \end{aligned}$$

3. we add an arrow on the lines connecting the i th and j th dots when $\eta_{ij} > 1$, pointing from i to j if $a'_{ii} \cdot a'_{jj} \neq 0$ and $|a'_{ii}| > |a'_{jj}|$ or if $a'_{ii} = 0$, $a'_{jj} \neq 0$, $|a'_{jj}| < 2$, and pointing from j to i if $a'_{ii} = 0$, $a'_{jj} \neq 0$, $|a'_{jj}| > 2$.

Since a basic Lie superalgebra possesses many inequivalent simple root systems, there will be for a basic Lie superalgebra many inequivalent Dynkin diagrams. For each basic Lie superalgebra, there is a particular Dynkin diagram which can be considered as canonical. Its characteristic is that it contains the smallest number of odd roots. Such a Dynkin diagram is called distinguished.

Definition: The *distinguished Dynkin diagram* is the Dynkin diagram associated to the distinguished simple root system (\rightarrow) to which corresponds the distinguished Cartan matrix (\rightarrow). It is constructed as follows: the even dots are given by the Dynkin diagram of the even part $\mathcal{G}_{\overline{0}}$ (it may be not connected) and the odd dot corresponds to the lowest weight of the representation $\mathcal{G}_{\overline{1}}$ of $\mathcal{G}_{\overline{0}}$.

The list of the distinguished Dynkin diagrams of the basic Lie superalgebras are given in Table 13 (see also Table 4 to 12).

\rightarrow Cartan matrices, Simple root systems.

For more details, see refs. [10, 21, 22].

16 Embeddings of $osp(1|2)$

The determination of the possible $osp(1|2)$ subsuperalgebras of a basic Lie superalgebra \mathcal{G} can be seen as the supersymmetric version of the Dynkin classification of $sl(2)$ subalgebras in a simple Lie algebra. Interest for this problem appeared recently in the framework of supersymmetric integrable models (in particular super-Toda theories) and super- W algebras [9, 25]. As in the algebraic case, it uses the notion of principal embedding (here superprincipal).

Definition: Let \mathcal{G} be a basic Lie superalgebra of rank r with simple root system $\Delta^0 = \{\alpha_1, \dots, \alpha_r\}$ and corresponding simple root generators $E_{\pm\alpha_i}$ in the Serre–Chevalley basis (\rightarrow). The generators of the $osp(1|2)$ *superprincipal embedding* in \mathcal{G} are defined by

$$F^+ = \sum_{i=1}^r E_{\alpha_i}, \quad F^- = \sum_{i=1}^r \sum_{j=1}^r a^{ji} E_{-\alpha_i}$$

a_{ij} being the Cartan matrix of \mathcal{G} and $a^{ij} = (a^{-1})_{ij}$. The even generators of the superprincipal $osp(1|2)$ are given by anticommutation of the odd generators F^+ and F^- :

$$H = 2\{F^+, F^-\}, \quad E^+ = 2\{F^+, F^+\}, \quad E^- = -2\{F^-, F^-\}$$

Not all the basic Lie superalgebras admit an $osp(1|2)$ superprincipal embedding. It is clear from the expression of the $osp(1|2)$ generators that a superprincipal embedding can be defined only if the superalgebra under consideration admits a completely odd simple root system (which corresponds to a Dynkin diagram with no white dot). This condition is however necessary but not sufficient (the superalgebra $A(n|n)$ does not admit a superprincipal embedding although it has a completely odd simple root system). The basic Lie superalgebras admitting a superprincipal $osp(1|2)$ are thus the following:

$$sl(n \pm 1|n), osp(2n \pm 1|2n), osp(2n|2n), osp(2n + 2|2n), D(2, 1; \alpha) \text{ with } \alpha \neq 0, \pm 1$$

The classification of the $osp(1|2)$ embeddings of a basic Lie superalgebra \mathcal{G} is given by the following theorem.

Theorem:

1. Any $osp(1|2)$ embedding in a basic Lie superalgebra \mathcal{G} can be considered as the superprincipal $osp(1|2)$ subsuperalgebra of a regular subsuperalgebra \mathcal{K} of \mathcal{G} .
2. For $\mathcal{G} = osp(2n \pm 2|2n)$ with $n \geq 2$, besides the $osp(1|2)$ superprincipal embeddings of item 1, there exist $osp(1|2)$ embeddings associated to the singular embeddings $osp(2k \pm 1|2k) \oplus osp(2n - 2k \pm 1|2n - 2k) \subset osp(2n \pm 2|2n)$ with $1 \leq k \leq \left\lfloor \frac{n-1}{2} \right\rfloor$.
3. For $\mathcal{G} = osp(2n|2n)$ with $n \geq 2$, besides the $osp(1|2)$ superprincipal embeddings of item 1, there exist $osp(1|2)$ embeddings associated to the singular embeddings $osp(2k \pm 1|2k) \oplus osp(2n - 2k \mp 1|2n - 2k) \subset osp(2n|2n)$ with $1 \leq k \leq \left\lfloor \frac{n-2}{2} \right\rfloor$.

17 Embeddings of $sl(2|1)$

In the same way one can consider $osp(1|2)$ embeddings of a basic Lie superalgebra, it is possible to determine the $sl(2|1)$ subsuperalgebras of a basic Lie superalgebra \mathcal{G} . This problem was recently considered for an exhaustive classification and characterization of all extended $N = 2$ superconformal algebras and all string theories obtained by gauging $N = 2$ Wess–Zumino–Witten models [33]. Let us consider the basic Lie superalgebra $sl(n + 1|n)$ with completely odd simple root system Δ^0 :

$$\Delta^0 = \left\{ \varepsilon_1 - \delta_1, \delta_1 - \varepsilon_2, \varepsilon_2 - \delta_2, \dots, \delta_{n-1} - \varepsilon_n, \varepsilon_n - \delta_n, \delta_n - \varepsilon_{n+1} \right\}$$

Denote by $E_{\pm(\varepsilon_i - \delta_i)}$, $E_{\pm(\delta_i - \varepsilon_{i+1})}$ ($1 \leq i \leq n$) the corresponding simple root generators in the Serre–Chevalley basis (\rightarrow). The $sl(2|1)$ *superprincipal embedding* in $sl(n + 1|n)$ is

defined as follows. The odd part of the superprincipal $sl(2|1)$ is generated by $F_{\pm\alpha}$ and $F_{\pm\beta}$ where

$$\begin{aligned} F_{+\alpha} &= \sum_{i=1}^n E_{\delta_i - \varepsilon_{i+1}} & F_{-\alpha} &= \sum_{i=1}^n \sum_{j=1}^{2n} a^{j,2i} E_{-\delta_i + \varepsilon_{i+1}} \\ F_{+\beta} &= \sum_{i=1}^n E_{\varepsilon_i - \delta_i} & F_{-\beta} &= \sum_{i=1}^n \sum_{j=1}^{2n} a^{j,2i-1} E_{-\varepsilon_i + \delta_i} \end{aligned}$$

a_{ij} being the Cartan matrix of $sl(n+1|n)$, $a^{ij} = (a^{-1})_{ij}$ and a_{ij} is chosen as

$$a = \begin{pmatrix} 0 & 1 & & & & \\ 1 & 0 & -1 & & & \\ & -1 & 0 & 1 & & \\ & & 1 & 0 & & \\ & & & & \ddots & \\ & & & & & 0 & 1 \\ & & & & & 1 & 0 \end{pmatrix}$$

The even generators of the superprincipal $sl(2|1)$ are given by anticommutation of the odd generators $F_{\pm\alpha}$ and $F_{\pm\beta}$:

$$\begin{aligned} \{F_{+\alpha}, F_{-\alpha}\} &= H_+ + H_- & \{F_{+\beta}, F_{-\beta}\} &= H_+ - H_- \\ \{F_{\pm\alpha}, F_{\pm\alpha}\} &= \{F_{\pm\beta}, F_{\pm\beta}\} = 0 & \{F_{\pm\alpha}, F_{\pm\beta}\} &= E_{\pm} \end{aligned}$$

One obtains finally

$$\begin{aligned} [E_{\pm}, F_{\pm\alpha}] &= 0 & [E_{\pm}, F_{\pm\beta}] &= 0 \\ [E_{\pm}, F_{\mp\alpha}] &= \mp F_{\pm\beta} & [E_{\pm}, F_{\mp\beta}] &= \mp F_{\pm\alpha} \\ [H_{\pm}, F_{+\alpha}] &= \pm \frac{1}{2} F_{+\alpha} & [H_{\pm}, F_{-\alpha}] &= \mp \frac{1}{2} F_{-\alpha} \\ [H_{\pm}, F_{+\beta}] &= \frac{1}{2} F_{+\beta} & [H_{\pm}, F_{-\beta}] &= -\frac{1}{2} F_{-\beta} \\ [H_+, E_{\pm}] &= \pm E_{\pm} & [H_-, E_{\pm}] &= 0 \end{aligned}$$

where

$$H_{\pm} = \frac{1}{2} \sum_{i=1}^n \sum_{j=1}^{2n} (a^{j,2i} H_{2i} \pm a^{j,2i-1} H_{2i-1})$$

Notice that this $sl(2|1)$ superprincipal embedding contains as maximal supersubalgebra the superprincipal $osp(1|2)$ with generators H_+ , E_{\pm} and $F_{\pm} = F_{\pm\alpha} + F_{\pm\beta}$.

The classification of the $sl(2|1)$ embeddings of a basic Lie superalgebra \mathcal{G} is given by the following theorem.

Theorem: Let \mathcal{G} be a basic Lie superalgebra. Any $sl(2|1)$ embedding into \mathcal{G} can be seen as the principal embedding of a (sum of) regular $sl(n|n \pm 1)$ subsuperalgebra of \mathcal{G} , except in the case of $osp(m|n)$ ($m > 1$), $F(4)$ and $D(2, 1; \alpha)$ where the (sum of) regular $osp(2|2)$ has also to be considered.

18 Exceptional Lie superalgebra $F(4)$

The Lie superalgebra $F(4)$ of rank 4 has dimension 40. The even part (of dimension 24) is a non-compact form of $sl(2) \oplus o(7)$ and the odd part (of dimension 16) is the spinorial representation $(2, 8)$ of $sl(2) \oplus o(7)$. In terms of the vectors $\varepsilon_1, \varepsilon_2, \varepsilon_3$ and δ such that $\varepsilon_i \cdot \varepsilon_j = \delta_{ij}, \delta^2 = -3, \varepsilon_i \cdot \delta = 0$, the root system $\Delta = \Delta_{\bar{0}} \cup \Delta_{\bar{1}}$ is given by

$$\Delta_{\bar{0}} = \{ \pm \delta, \pm \varepsilon_i \pm \varepsilon_j, \pm \varepsilon_i \} \quad \text{and} \quad \Delta_{\bar{1}} = \{ \frac{1}{2}(\pm \delta \pm \varepsilon_1 \pm \varepsilon_2 \pm \varepsilon_3) \}$$

The different simple root systems of $F(4)$ with the corresponding Dynkin diagrams and Cartan matrices are the following:

Simple root system $\Delta^0 = \{ \alpha_1 = \frac{1}{2}(\delta - \varepsilon_1 - \varepsilon_2 - \varepsilon_3), \alpha_2 = \varepsilon_3, \alpha_3 = \varepsilon_2 - \varepsilon_3, \alpha_4 = \varepsilon_1 - \varepsilon_2 \}$



$$\text{Cartan matrix} = \begin{pmatrix} 0 & 1 & 0 & 0 \\ -1 & 2 & -2 & 0 \\ 0 & -1 & 2 & -1 \\ 0 & 0 & -1 & 2 \end{pmatrix}$$

Simple root system $\Delta^0 = \{ \alpha_1 = \frac{1}{2}(-\delta + \varepsilon_1 + \varepsilon_2 + \varepsilon_3), \alpha_2 = \frac{1}{2}(\delta - \varepsilon_1 - \varepsilon_2 + \varepsilon_3), \alpha_3 = \varepsilon_2 - \varepsilon_3, \alpha_4 = \varepsilon_1 - \varepsilon_2 \}$



$$\text{Cartan matrix} = \begin{pmatrix} 0 & 1 & 0 & 0 \\ -1 & 0 & 2 & 0 \\ 0 & -1 & 2 & -1 \\ 0 & 0 & -1 & 2 \end{pmatrix}$$

Simple root system $\Delta^0 = \{ \alpha_1 = \varepsilon_1 - \varepsilon_2, \alpha_2 = \frac{1}{2}(\delta - \varepsilon_1 + \varepsilon_2 - \varepsilon_3), \alpha_3 = \frac{1}{2}(-\delta + \varepsilon_1 + \varepsilon_2 - \varepsilon_3), \alpha_4 = \varepsilon_3 \}$

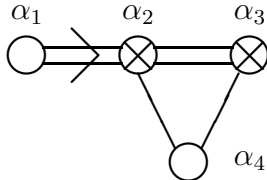

$$\text{Cartan matrix} = \begin{pmatrix} 2 & -1 & 0 & 0 \\ -2 & 0 & 2 & 1 \\ 0 & -2 & 0 & 1 \\ 0 & -1 & -1 & 2 \end{pmatrix}$$

Simple root system $\Delta^0 = \{ \alpha_1 = \frac{1}{2}(\delta + \varepsilon_1 - \varepsilon_2 - \varepsilon_3), \alpha_2 = \frac{1}{2}(\delta - \varepsilon_1 + \varepsilon_2 + \varepsilon_3), \alpha_3 = \frac{1}{2}(-\delta + \varepsilon_1 - \varepsilon_2 + \varepsilon_3), \alpha_4 = \varepsilon_2 - \varepsilon_3 \}$



$$\text{Cartan matrix} = \begin{pmatrix} 0 & 3 & 2 & 0 \\ -3 & 0 & 1 & 0 \\ -2 & -1 & 0 & 1 \\ 0 & 0 & -2 & 2 \end{pmatrix}$$

Simple root system $\Delta^0 = \{ \alpha_1 = \delta, \alpha_2 = \frac{1}{2}(-\delta + \varepsilon_1 - \varepsilon_2 - \varepsilon_3), \alpha_3 = \varepsilon_3, \alpha_4 = \varepsilon_2 - \varepsilon_3 \}$

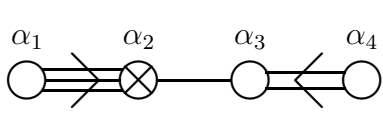

$$\text{Cartan matrix} = \begin{pmatrix} 2 & -1 & 0 & 0 \\ -3 & 0 & 1 & 0 \\ 0 & -1 & 2 & -2 \\ 0 & 0 & -1 & 2 \end{pmatrix}$$

Simple root system $\Delta^0 = \left\{ \alpha_1 = \delta, \alpha_2 = \frac{1}{2}(-\delta - \varepsilon_1 + \varepsilon_2 + \varepsilon_3), \alpha_3 = \varepsilon_1 - \varepsilon_2, \alpha_4 = \varepsilon_2 - \varepsilon_3 \right\}$

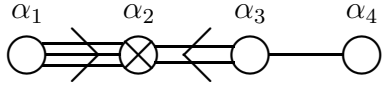

$$\text{Cartan matrix} = \begin{pmatrix} 2 & -1 & 0 & 0 \\ -3 & 0 & 2 & 0 \\ 0 & -1 & 2 & -1 \\ 0 & 0 & -1 & 2 \end{pmatrix}$$

Denoting by T_i where $i = 1, 2, 3$ the generators of $sl(2)$, by $M_{pq} = -M_{qp}$ where $1 \leq p \neq q \leq 7$ the generators of $so(7)$ and by $F_{\alpha\mu}$ where $\alpha = +, -$ and $1 \leq \mu \leq 8$ the generators of the odd part, the commutation relations of $F(4)$ read as:

$$\begin{aligned} [T_i, T_j] &= i\varepsilon_{ijk}T_k & [T_i, M_{pq}] &= 0 \\ [M_{pq}, M_{rs}] &= \delta_{qr}M_{ps} + \delta_{ps}M_{qr} - \delta_{pr}M_{qs} - \delta_{qs}M_{pr} \\ [T_i, F_{\alpha\mu}] &= \frac{1}{2}\sigma_{\beta\alpha}^i F_{\beta\mu} & [M_{pq}, F_{\alpha\mu}] &= \frac{1}{2}(\gamma_p\gamma_q)_{\nu\mu}F_{\alpha\nu} \\ \{F_{\alpha\mu}, F_{\beta\nu}\} &= 2C_{\mu\nu}^{(8)}(C^{(2)}\sigma^i)_{\alpha\beta}T_i + \frac{1}{3}C_{\alpha\beta}^{(2)}(C^{(8)}\gamma_p\gamma_q)_{\mu\nu}M_{pq} \end{aligned}$$

where $\sigma^1, \sigma^2, \sigma^3$ are the Pauli matrices and $C^{(2)}$ ($= i\sigma^2$) is the 2×2 charge conjugation matrix. The 8-dimensional matrices γ_p form a Clifford algebra $\{\gamma_p, \gamma_q\} = 2\delta_{pq}$ and $C^{(8)}$ is the 8×8 charge conjugation matrix. They can be chosen, \mathbb{I} being the 2×2 unit matrix, as (\rightarrow Clifford algebra):

$$\begin{aligned} \gamma_1 &= \sigma^1 \otimes \sigma^3 \otimes \mathbb{I}, & \gamma_2 &= \sigma^1 \otimes \sigma^1 \otimes \sigma^3, & \gamma_3 &= \sigma^1 \otimes \sigma^1 \otimes \sigma^1 \\ \gamma_4 &= \sigma^2 \otimes \mathbb{I} \otimes \mathbb{I}, & \gamma_5 &= \sigma^1 \otimes \sigma^2 \otimes \mathbb{I}, & \gamma_6 &= \sigma^1 \otimes \sigma^1 \otimes \sigma^2 \\ \gamma_7 &= \sigma^3 \otimes \mathbb{I} \otimes \mathbb{I} \end{aligned}$$

The generators in the Cartan-Weyl basis are given by (with obvious notations):

$$\begin{aligned} H_1 &= T_3 & E_{\pm\delta} &= T_1 \pm iT_2 \\ H_2 &= iM_{41} & H_3 &= iM_{52} & H_4 &= iM_{63} \\ E_{\pm\varepsilon_1} &= \frac{i}{\sqrt{2}}(M_{17} \pm iM_{47}) & E_{\pm\varepsilon_2} &= \frac{i}{\sqrt{2}}(M_{27} \pm iM_{57}) & E_{\pm\varepsilon_3} &= \frac{i}{\sqrt{2}}(M_{37} \pm iM_{67}) \\ E_{\pm(\varepsilon_1+\varepsilon_2)} &= \frac{i}{2}(M_{12} \pm iM_{42} + M_{54} \pm iM_{15}) & E_{\pm(\varepsilon_1-\varepsilon_2)} &= \frac{i}{2}(M_{12} \pm iM_{42} - M_{54} \mp iM_{15}) \\ E_{\pm(\varepsilon_2+\varepsilon_3)} &= \frac{i}{2}(M_{23} \pm iM_{53} + M_{65} \pm iM_{26}) & E_{\pm(\varepsilon_2-\varepsilon_3)} &= \frac{i}{2}(M_{23} \pm iM_{53} - M_{65} \mp iM_{26}) \\ E_{\pm(\varepsilon_1+\varepsilon_3)} &= \frac{i}{2}(M_{13} \pm iM_{43} + M_{64} \pm iM_{16}) & E_{\pm(\varepsilon_1-\varepsilon_3)} &= \frac{i}{2}(M_{13} \pm iM_{43} - M_{64} \mp iM_{16}) \\ E_{\frac{1}{2}(\pm\delta \pm \varepsilon_1 \pm \varepsilon_2 \pm \varepsilon_3)} &= F_{\alpha,\mu} \end{aligned}$$

where in the last equation the index α and the sign in $\pm\delta$ are in one-to-one correspondence and the correspondence between the index μ and the signs in $\pm\varepsilon_1 \pm \varepsilon_2 \pm \varepsilon_3$ is given by $(1, 2, 3, 4, 5, 6, 7, 8) = (+++, +--, --+, -+-, -+-, -+-, ---, +-+, +-+)$.

19 Exceptional Lie superalgebra $G(3)$

The Lie superalgebra $G(3)$ of rank 3 has dimension 31. The even part (of dimension 17) is a non-compact form of $sl(2) \oplus G_2$ and the odd part (of dimension 14) is the representation $(2, 7)$ of $sl(2) \oplus G_2$. In terms of the vectors $\varepsilon_1, \varepsilon_2, \varepsilon_3$ with $\varepsilon_1 + \varepsilon_2 + \varepsilon_3 = 0$ and δ such that $\varepsilon_i \cdot \varepsilon_j = 1 - 3\delta_{ij}, \delta^2 = 2, \varepsilon_i \cdot \delta = 0$, the root system $\Delta = \Delta_{\bar{0}} \cup \Delta_{\bar{1}}$ is given by

$$\Delta_{\bar{0}} = \{ \pm 2\delta, \varepsilon_i - \varepsilon_j, \pm \varepsilon_i \} \quad \text{and} \quad \Delta_{\bar{1}} = \{ \pm \varepsilon_i \pm \delta, \pm \delta \}$$

The different simple root systems of $G(3)$ with the corresponding Dynkin diagrams and Cartan matrices are the following:

Simple root system $\Delta^0 = \{ \alpha_1 = \delta + \varepsilon_3, \alpha_2 = \varepsilon_1, \alpha_3 = \varepsilon_2 - \varepsilon_1 \}$



$$\text{Cartan matrix} = \begin{pmatrix} 0 & 1 & 0 \\ -1 & 2 & -3 \\ 0 & -1 & 2 \end{pmatrix}$$

Simple root system $\Delta^0 = \{ \alpha_1 = -\delta - \varepsilon_3, \alpha_2 = \delta - \varepsilon_2, \alpha_3 = \varepsilon_2 - \varepsilon_1 \}$



$$\text{Cartan matrix} = \begin{pmatrix} 0 & 1 & 0 \\ -1 & 0 & 3 \\ 0 & -1 & 2 \end{pmatrix}$$

Simple root system $\Delta^0 = \{ \alpha_1 = \delta, \alpha_2 = -\delta + \varepsilon_1, \alpha_3 = \varepsilon_2 - \varepsilon_1 \}$



$$\text{Cartan matrix} = \begin{pmatrix} 2 & -2 & 0 \\ -2 & 0 & 3 \\ 0 & -1 & 2 \end{pmatrix}$$

Simple root system $\Delta^0 = \{ \alpha_1 = \delta - \varepsilon_1, \alpha_2 = -\delta + \varepsilon_2, \alpha_3 = \varepsilon_1 \}$



$$\text{Cartan matrix} = \begin{pmatrix} 0 & 3 & 2 \\ -3 & 0 & 1 \\ -2 & -1 & 2 \end{pmatrix}$$

In order to write the commutation relations of $G(3)$, it is convenient to use a $so(7)$ basis. Consider the $so(7)$ generators $M_{pq} = -M_{qp}$ where $1 \leq p \neq q \leq 7$. The singular embedding $G_2 \subset so(7)$ is obtained by imposing to the generators M_{pq} the constraints

$$\xi_{ijk} M_{ij} = 0$$

where the tensor ξ_{ijk} is completely antisymmetric and whose non-vanishing components are

$$\xi_{123} = \xi_{145} = \xi_{176} = \xi_{246} = \xi_{257} = \xi_{347} = \xi_{365} = 1$$

Denoting by T_i where $i = 1, 2, 3$ the generators of $sl(2)$, by $F_{\alpha p}$ where $\alpha = +, -$ and $1 \leq p \leq 7$ the generators of the odd part, the commutation relations of $G(3)$ read as:

$$\begin{aligned} [T_i, T_j] &= i\varepsilon_{ijk}T_k & [T_i, M_{pq}] &= 0 \\ [M_{pq}, M_{rs}] &= \delta_{qr}M_{ps} + \delta_{ps}M_{qr} - \delta_{pr}M_{qs} - \delta_{qs}M_{pr} + \frac{1}{3}\xi_{pqu}\xi_{rsu}M_{uv} \\ [T_i, F_{\alpha p}] &= \frac{1}{2}\sigma_{\alpha\beta}^i F_{\beta p} & [M_{pq}, F_{\alpha r}] &= \frac{2}{3}\delta_{qr}F_{\alpha p} - \frac{2}{3}\delta_{pr}F_{\alpha q} + \frac{1}{3}\zeta_{pqrs}F_{\alpha s} \\ \{F_{\alpha p}, F_{\beta q}\} &= 2\delta_{pq}(C\sigma^i)_{\alpha\beta}T_i + \frac{3}{2}C_{\alpha\beta}M_{pq} \end{aligned}$$

where the tensor ζ_{pqrs} is completely antisymmetric and whose non-vanishing components are

$$\zeta_{1247} = \zeta_{1265} = \zeta_{1364} = \zeta_{1375} = \zeta_{2345} = \zeta_{2376} = \zeta_{4576} = 1$$

It can be written as

$$\zeta_{pqrs} = \delta_{ps}\delta_{qr} - \delta_{pr}\delta_{qs} + \sum_{u=1}^7 \xi_{pqu}\xi_{rsu}$$

The σ^i 's are the Pauli matrices and $C (= i\sigma^2)$ is the 2×2 charge conjugation matrix. In terms of the M_{pq} , the generators of G_2 are given by

$$\begin{aligned} E_1 &= i(M_{17} - M_{24}) & E'_1 &= i\sqrt{3}(M_{17} + M_{24}) \\ E_2 &= i(M_{21} - M_{74}) & E'_2 &= -i\sqrt{3}(M_{21} + M_{74}) \\ E_3 &= i(M_{72} - M_{14}) & E'_3 &= i\sqrt{3}(M_{72} + M_{14}) = -E_8 \\ E_4 &= i(M_{43} - M_{16}) & E'_4 &= i\sqrt{3}(M_{43} + M_{16}) \\ E_5 &= i(M_{31} - M_{46}) & E'_5 &= i\sqrt{3}(M_{31} + M_{46}) \\ E_6 &= i(M_{62} - M_{73}) & E'_6 &= i\sqrt{3}(M_{62} + M_{73}) \\ E_7 &= i(M_{32} - M_{67}) & E'_7 &= i\sqrt{3}(M_{32} + M_{67}) \end{aligned}$$

The E_a 's with $a = 1, \dots, 8$ generate $sl(3)$ and satisfy the commutation relations

$$[E_a, E_b] = 2if_{abc}E_c$$

where f_{abc} are the usual totally antisymmetric Gell-Mann structure constants. The commutation relations between the G_2 generators E_a and E'_i ($i = 1, 2, 4, 5, 6, 7$) are

$$\begin{aligned} [E_a, E'_i] &= 2ic_{aij}E'_j \\ [E'_i, E'_j] &= 2i(c_{aij}E_a + c'_{ijk}E'_k) \end{aligned}$$

where the structure constants c_{aij} (antisymmetric in the indices i, j) and c'_{ijk} (totally antisymmetric) are

$$c_{147} = c_{156} = c_{257} = c_{345} = c_{367} = c_{417} = c_{725} = 1/2$$

$$\begin{aligned}
c_{246} &= c_{426} = c_{516} = c_{527} = c_{615} = c_{624} = c_{714} = -1/2 \\
c_{845} &= c_{876} = -1/2\sqrt{3} \quad c_{812} = -1/\sqrt{3} \\
c'_{147} &= c'_{165} = c'_{246} = c'_{257} = -1/\sqrt{3}
\end{aligned}$$

The generators E_3 and E_8 constitute a Cartan basis of the G_2 algebra. One can also take a basis H_1, H_2, H_3 such that $H_1 + H_2 + H_3 = 0$ given by $H_1 = \frac{1}{2}(E_3 + \frac{\sqrt{3}}{3}E_8)$, $H_2 = \frac{1}{2}(-E_3 + \frac{\sqrt{3}}{3}E_8)$, $H_3 = -\frac{\sqrt{3}}{3}E_8$. The generators in the Cartan-Weyl basis are given by (with obvious notations):

$$\begin{aligned}
H_1 &= \frac{1}{2}(E_3 + \frac{\sqrt{3}}{3}E_8) & H_2 &= \frac{1}{2}(-E_3 + \frac{\sqrt{3}}{3}E_8) & H_3 &= -\frac{\sqrt{3}}{3}E_8 \\
E_{\pm(\varepsilon_1 - \varepsilon_2)} &= E_1 \pm iE_2 & E_{\pm(\varepsilon_2 - \varepsilon_3)} &= E_6 \pm iE_7 & E_{\pm(\varepsilon_1 - \varepsilon_3)} &= E_4 \pm iE_5 \\
E_{\pm\varepsilon_1} &= E'_7 \mp iE'_6 & E_{\pm\varepsilon_2} &= E'_4 \mp iE'_5 & E_{\pm\varepsilon_3} &= E'_1 \mp iE'_2 \\
E_{\pm\delta + \varepsilon_1} &= F_{\pm 1} + iF_{\pm 4} & E_{\pm\delta + \varepsilon_2} &= F_{\pm 7} + iF_{\pm 2} & E_{\pm\delta + \varepsilon_3} &= F_{\pm 3} + iF_{\pm 6} \\
E_{\pm\delta - \varepsilon_1} &= F_{\pm 1} - iF_{\pm 4} & E_{\pm\delta - \varepsilon_2} &= F_{\pm 7} - iF_{\pm 2} & E_{\pm\delta - \varepsilon_3} &= F_{\pm 3} - iF_{\pm 6} \\
H_4 &= T_3 & E_{\pm 2\delta} &= T_1 \pm iT_2 & E_{\pm\delta} &= F_{\pm 5}
\end{aligned}$$

20 Exceptional Lie superalgebras $D(2, 1; \alpha)$

The Lie superalgebras $D(2, 1; \alpha)$ with $\alpha \neq 0, -1, \infty$ form a one-parameter family of superalgebras of rank 3 and dimension 17. The even part (of dimension 9) is a non-compact form of $sl(2) \oplus sl(2) \oplus sl(2)$ and the odd part (of dimension 8) is the spinorial representation $(2, 2, 2)$ of the even part. In terms of the vectors $\varepsilon_1, \varepsilon_2, \varepsilon_3$ such that $\varepsilon_1^2 = -(1 + \alpha)/2, \varepsilon_2^2 = 1/2, \varepsilon_3^2 = \alpha/2$ and $\varepsilon_i \cdot \varepsilon_j = 0$ if $i \neq j$, the root system $\Delta = \Delta_{\overline{0}} \cup \Delta_{\overline{1}}$ is given by

$$\Delta_{\overline{0}} = \{ \pm 2\varepsilon_i \} \quad \text{and} \quad \Delta_{\overline{1}} = \{ \pm \varepsilon_1 \pm \varepsilon_2 \pm \varepsilon_3 \}$$

$D(2, 1; \alpha)$ is actually a deformation of the superalgebra $D(2, 1)$ which corresponds to the case $\alpha = 1$.

The different simple root systems of $D(2, 1; \alpha)$ with the corresponding Dynkin diagrams and Cartan matrices are the following:

Simple root system $\Delta^0 = \{ \alpha_1 = \varepsilon_1 - \varepsilon_2 - \varepsilon_3, \alpha_2 = 2\varepsilon_2, \alpha_3 = 2\varepsilon_3 \}$

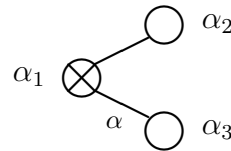

$$\text{Cartan matrix} = \begin{pmatrix} 0 & 1 & \alpha \\ -1 & 2 & 0 \\ -1 & 0 & 2 \end{pmatrix}$$

Simple root system $\Delta^0 = \{ \alpha_1 = 2\varepsilon_2, \alpha_2 = -\varepsilon_1 - \varepsilon_2 + \varepsilon_3, \alpha_3 = 2\varepsilon_1 \}$



$$\text{Cartan matrix} = \begin{pmatrix} 2 & -1 & 0 \\ 1 & 0 & 1 + \alpha \\ 0 & -1 & 2 \end{pmatrix}$$

Simple root system $\Delta^0 = \{\alpha_1 = 2\varepsilon_3, \alpha_2 = 2\varepsilon_1, \alpha_3 = -\varepsilon_1 + \varepsilon_2 - \varepsilon_3\}$

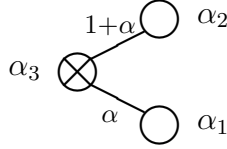

$$\text{Cartan matrix} = \begin{pmatrix} 2 & 0 & \alpha \\ 0 & 2 & 1 + \alpha \\ -1 & -1 & 0 \end{pmatrix}$$

Simple root system $\Delta^0 = \{\alpha_1 = -\varepsilon_1 + \varepsilon_2 + \varepsilon_3, \alpha_2 = \varepsilon_1 + \varepsilon_2 - \varepsilon_3, \alpha_3 = \varepsilon_1 - \varepsilon_2 + \varepsilon_3\}$

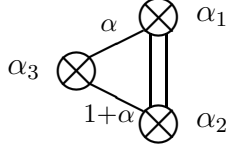

$$\text{Cartan matrix} = \begin{pmatrix} 0 & 1 & \alpha \\ 1 & 0 & -1 - \alpha \\ \alpha & -1 - \alpha & 0 \end{pmatrix}$$

(the labels on the links are equal to the absolute values of the scalar products of the simple roots which are linked.)

Denoting by $T_i^{(a)}$ where $i = 1, 2, 3$ and $a = 1, 2, 3$ the generators of the three $sl(2)$ and by $F_{\beta\beta'\beta''}$ where $\beta, \beta', \beta'' = +, -$, the generators of the odd part, the commutation relations of $D(2, 1; \alpha)$ read as:

$$\begin{aligned} [T_i^{(a)}, T_j^{(b)}] &= i\delta_{ab}\varepsilon_{ijk}T_k^{(a)} \\ [T_i^{(1)}, F_{\beta\beta'\beta''}] &= \frac{1}{2}\sigma_{\gamma\beta}^i F_{\gamma\beta'\beta''} \\ [T_i^{(2)}, F_{\beta\beta'\beta''}] &= \frac{1}{2}\sigma_{\gamma'\beta'}^i F_{\beta\gamma'\beta''} \\ [T_i^{(3)}, F_{\beta\beta'\beta''}] &= \frac{1}{2}\sigma_{\gamma''\beta''}^i F_{\beta\beta'\gamma''} \\ \{F_{\beta\beta'\beta''}, F_{\gamma\gamma'\gamma''}\} &= s_1 C_{\beta'\gamma'} C_{\beta''\gamma''} (C\sigma^i)_{\beta\gamma} T_i^{(1)} + s_2 C_{\beta''\gamma''} C_{\beta\gamma} (C\sigma^i)_{\beta'\gamma'} T_i^{(2)} \\ &\quad + s_3 C_{\beta\gamma} C_{\beta'\gamma'} (C\sigma^i)_{\beta''\gamma''} T_i^{(3)} \end{aligned}$$

where $s_1 + s_2 + s_3 = 0$ is imposed by the generalized Jacobi identity. The σ^i 's are the Pauli matrices and $C (= i\sigma^2)$ is the 2×2 charge conjugation matrix. Since the superalgebras defined by the triplets $\lambda s_1, \lambda s_2, \lambda s_3$ ($\lambda \in \mathbb{C}$) are isomorphic, one can set $s_2/s_1 = \alpha$ and $s_3/s_1 = -1 - \alpha$ (the normalization of the roots given above corresponds to the choice $s_1 = 1, s_2 = \alpha$ and $s_3 = -1 - \alpha$). One can deduce after some simple calculation that:

Property: The superalgebras defined by the parameters $\alpha, \alpha^{-1}, -1 - \alpha$ and $\frac{-\alpha}{1 + \alpha}$ are isomorphic. Moreover, for the values 1, -2 and -1/2 of the parameter α , the superalgebra $D(2, 1; \alpha)$ is isomorphic to $D(2, 1)$.

In the Cartan-Weyl basis, the generators are given by:

$$\begin{aligned} H_1 &= T_3^{(1)} & H_2 &= T_3^{(2)} & H_3 &= T_3^{(3)} \\ E_{\pm 2\varepsilon_1} &= T_1^{(1)} \pm iT_2^{(1)} & E_{\pm 2\varepsilon_2} &= T_1^{(2)} \pm iT_2^{(2)} & E_{\pm 2\varepsilon_3} &= T_1^{(3)} \pm iT_2^{(3)} \\ E_{\pm\varepsilon_1 \pm \varepsilon_2 \pm \varepsilon_3} &= F_{\beta\beta'\beta''} \end{aligned}$$

where in the last equation the signs in the indices $\pm\varepsilon_1 \pm \varepsilon_2 \pm \varepsilon_3$ and the indices $\beta\beta'\beta''$ are in one-to-one correspondence.

21 Gelfand-Zetlin basis

Consider a finite dimensional irreducible representation π of $gl(m|n)$ with highest weight $\Lambda = (\lambda_1, \dots, \lambda_{m+n})$. The coefficients λ_i are complex numbers such that the differences $\lambda_i - \lambda_{i+1} \in \mathbb{N}$ for $i \neq m$. The construction of the Gelfand-Zetlin basis stands on the reduction of π with respect to the chain of subalgebras

$$gl(m|n) \supset gl(m|n-1) \supset \dots \supset gl(m) \supset gl(m-1) \supset \dots \supset gl(1)$$

It is sufficient of course to achieve the first reduction.

This construction has been done up to now only in the case of the star representations of $gl(m|n)$. Let us recall that the superalgebra $gl(m|n)$ has two classes of star representations and two classes of superstar representations (\rightarrow Star and superstar representations): if e_{IJ} is the standard basis of $gl(m|n)$ (\rightarrow Unitary superalgebras) where $1 \leq I, J \leq m+n$, the two star representations π are defined by $\pi^\dagger(e_{IJ}) = \pi(e_{IJ}^\dagger)$ where

$$\begin{aligned} e_{IJ}^\dagger &= e_{JI} && \text{adjoint 1} \\ e_{IJ}^\dagger &= (-1)^{\deg(e_{IJ})} e_{JI} && \text{adjoint 2} \end{aligned}$$

and the two superstar representations π by $\pi^\ddagger(e_{IJ}) = \pi(e_{IJ}^\ddagger)$ where

$$\begin{aligned} e_{IJ}^\ddagger &= \begin{cases} e_{IJ} & \text{for } \deg(e_{IJ}) = 0 \\ e_{IJ} \operatorname{sign}(J-I) & \text{for } \deg(e_{IJ}) = 1 \end{cases} && \text{superadjoint 1} \\ e_{IJ}^\ddagger &= \begin{cases} e_{IJ} & \text{for } \deg(e_{IJ}) = 0 \\ e_{IJ} \operatorname{sign}(I-J) & \text{for } \deg(e_{IJ}) = 1 \end{cases} && \text{superadjoint 2} \end{aligned}$$

In the following, we will concentrate on the star representations.

Theorem: The irreducible representation of $gl(m|n)$ with highest weight $\Lambda = (\lambda_1, \dots, \lambda_{m+n})$ is a star representation if and only if all the λ_i are real and the following conditions are satisfied:

1. $\lambda_m + \lambda_{m+n} - n + 1 \geq 0$.
2. there is some $k \in \{1, \dots, n-1\}$ such that $0 \leq \lambda_m + \lambda_{m+k} - k + 1 \leq 1$ and $\lambda_{m+k} = \lambda_{m+k+1} = \dots = \lambda_{m+n}$.
3. $\lambda_1 + \lambda_{m+1} + m - 1 \leq 0$.

Theorem: Let π be a star representation of $gl(m|n)$ with highest weight $\Lambda = (\lambda_1, \dots, \lambda_{m+n})$. The reduction of the representation π of $gl(m|n)$ with respect to of $gl(m|n-1)$ gives exactly once the irreducible representations of $gl(m|n-1)$ with highest weights

$\Lambda' = (\lambda'_1, \dots, \lambda'_{m+n-1})$ where the differences $\lambda_i - \lambda'_i \in \mathbb{N}$ for $1 \leq i \leq m+n-1$ and the coefficients satisfy the following inequalities:

$$\begin{aligned} & \cdot \lambda_1 \geq \lambda_2 \geq \dots \geq \lambda_{m-1} \geq \lambda_m \\ & \cdot \lambda'_1 \geq \lambda'_2 \geq \dots \geq \lambda'_{m-1} \geq \lambda'_m \\ & \cdot \lambda_i \geq \lambda'_i \geq \lambda_i - \varepsilon_i \quad (1 \leq i \leq m) \\ & \cdot \lambda_{m+1} \geq \lambda'_{m+1} \geq \lambda_{m+2} \geq \lambda'_{m+2} \dots \geq \lambda_{m+n-1} \geq \lambda'_{m+n-1} \geq \lambda_{m+n} \end{aligned}$$

where

$$\begin{aligned} \varepsilon_1 &= \begin{cases} 0 & \text{if } \lambda_1 + \lambda_{m+1} + m - 1 = 0 \\ 1 & \text{otherwise} \end{cases} \\ \varepsilon_2 &= \dots = \varepsilon_{m-1} = 1 \\ \varepsilon_m &= \begin{cases} 0 & \text{if } \lambda_1 + \lambda_{m+1} + m - 1 = 0 \text{ or } \lambda_m + \lambda_{m+k} + k - 1 = 0 \\ & \text{with } \lambda'_{m+k-1} \neq \lambda_{m+k} \quad (2 \leq k \leq n) \\ 1 & \text{otherwise} \end{cases} \end{aligned}$$

$\varepsilon_m = 0$ in the case of the star adjoint 1 representations while $\varepsilon_1 = 0$ for the star adjoint 2 representations.

It follows that the Gelfand-Zetlin basis for the star representations of $gl(m|n)$ is given by the following theorem:

Theorem: Let π be a star representation of $gl(m|n)$ with highest weight $\Lambda = (\lambda_1, \dots, \lambda_N) \equiv (\lambda_{1N}, \dots, \lambda_{NN})$ where $N = m+n$. The Gelfand-Zetlin basis in the representation space $\mathcal{V}(\Lambda)$ is given by

$$e_\Lambda = \left| \begin{array}{cccccc} \lambda_{1N} & \lambda_{2N} & \lambda_{3N} & \dots & \lambda_{NN} \\ & \lambda_{1,N-1} & \lambda_{2,N-1} & \dots & \lambda_{N-1,N-1} \\ & & \ddots & & \ddots \\ & & & \lambda_{12} & \lambda_{22} \\ & & & & \lambda_{11} \end{array} \right\rangle$$

where the real numbers λ_{ij} , with $\lambda_{i,j+1} - \lambda_{ij} \in \mathbb{N}$, satisfy the following inequalities:

$$\begin{aligned} & \cdot \lambda_{1,j+1} \geq \lambda_{2,j+1} \geq \dots \geq \lambda_{m-1,j+1} \geq \lambda_{m,j+1} \\ & \cdot \lambda_{1j} \geq \lambda_{2j} \geq \dots \geq \lambda_{m-1,j} \geq \lambda_{mj} \\ & \cdot \lambda_{i,j+1} \geq \lambda_{ij} \geq \lambda_{i,j+1} - \varepsilon_{i,j+1} \quad (1 \leq i \leq m) \\ & \cdot \lambda_{i,j+1} \geq \lambda_{ij} \geq \lambda_{i+1,j+1} \quad \text{for } j \geq i \geq m+1 \text{ or } i \leq j \leq m-1 \end{aligned}$$

where

$$\begin{aligned} \varepsilon_{1,j+1} &= \begin{cases} 0 & \text{if } \lambda_{1,j+1} + \lambda_{m+1,j+1} + m - 1 = 0 \\ 1 & \text{otherwise} \end{cases} \\ \varepsilon_{m,j+1} &= \begin{cases} 0 & \text{if } \lambda_{m,j+1} + \lambda_{m+1,j+1} = 0 \text{ or } \lambda_{m,j+1} + \lambda_{m+k,j+1} - k + 1 = 0 \\ & \text{with } \lambda_{m+k-1,j} \neq \lambda_{m+k,j+1} \quad (1 \leq k \leq j+1) \\ 1 & \text{otherwise} \end{cases} \end{aligned}$$

and $\varepsilon_{2,j+1} = \dots = \varepsilon_{m-1,j+1} = 1$. Notice that $\varepsilon_{m,j+1} = 0$ in the case of the star adjoint 1 representations while $\varepsilon_{1,j+1} = 0$ for the star adjoint 2 representations.

For more details on the Gelfand-Zetlin basis for $gl(m|n)$, in particular the action of the $gl(m|n)$ generators on the basis vectors, see ref. [18].

22 Grassmann algebras

Definition: The real (resp. complex) Grassmann algebra $\Gamma(n)$ of order n is the algebra over \mathbb{R} (resp. \mathbb{C}) generated from the unit element 1 and the n quantities θ_i (called Grassmann variables) which satisfy the anticommutation relations

$$\{\theta_i, \theta_j\} = 0$$

This algebra has 2^n generators $1, \theta_i, \theta_i\theta_j, \theta_i\theta_j\theta_k, \dots, \theta_1 \dots \theta_n$.

Putting $\deg \theta_i = \bar{1}$, the algebra $\Gamma(n)$ acquires the structure of a superalgebra: $\Gamma(n) = \Gamma(n)_{\bar{0}} \oplus \Gamma(n)_{\bar{1}}$, where $\Gamma(n)_{\bar{0}}$ is generated by the monomials in θ_i with an even number of θ_i (even generators) and $\Gamma(n)_{\bar{1}}$ by the monomials in θ_i with an odd number of θ_i (odd generators). Since $\dim \Gamma(n)_{\bar{0}} = \dim \Gamma(n)_{\bar{1}} = 2^{n-1}$, the superalgebra $\Gamma(n)$ is supersymmetric. The Grassmann superalgebra is associative and commutative (in the sense of the superbracket).

It is possible to define the complex conjugation on the Grassmann variables. However, there are two possibilities to do so. If c is a complex number and \bar{c} its complex conjugate, θ_i, θ_j being Grassmann variables, the star operation, denoted by $*$, is defined by

$$(c\theta_i)^* = \bar{c}\theta_i^*, \quad \theta_i^{**} = \theta_i, \quad (\theta_i\theta_j)^* = \theta_j^*\theta_i^*$$

and the superstar operation, denoted by $\#$, is defined by

$$(c\theta_i)^\# = \bar{c}\theta_i^\#, \quad \theta_i^{\#\#} = -\theta_i, \quad (\theta_i\theta_j)^\# = \theta_i^\#\theta_j^\#$$

Let us mention that the derivation superalgebra $(\rightarrow) \text{Der } \Gamma(n)$ of $\Gamma(n)$ is the Cartan type (\rightarrow) simple Lie superalgebra $W(n)$.

23 Killing form

Definition: Let \mathcal{G} be a Lie superalgebra. One defines the bilinear form B_π associated to a representation π of \mathcal{G} as a bilinear form from $\mathcal{G} \times \mathcal{G}$ into the field of real numbers \mathbb{R} such that

$$B_\pi(X, Y) = \text{str}(\pi(X), \pi(Y)), \quad \forall X, Y \in \mathcal{G}$$

where $\pi(X)$ are the matrices of the generators $X \in \mathcal{G}$ in the representation π .

If $\{X_i\}$ is the basis of generators of \mathcal{G} ($i = 1, \dots, \dim \mathcal{G}$), one has therefore

$$B_\pi(X_i, Y_j) = \text{str}(\pi(X_i), \pi(Y_j)) = g_{ij}^\pi$$

Definition: A bilinear form B on $\mathcal{G} = \mathcal{G}_\bar{0} \oplus \mathcal{G}_\bar{1}$ is called

- consistent if $B(X, Y) = 0$ for all $X \in \mathcal{G}_\bar{0}$ and all $Y \in \mathcal{G}_\bar{1}$.
- supersymmetric if $B(X, Y) = (-1)^{\deg X \cdot \deg Y} B(Y, X)$, for all $X, Y \in \mathcal{G}$.
- invariant if $B(\llbracket X, Y \rrbracket, Z) = B(X, \llbracket Y, Z \rrbracket)$, for all $X, Y, Z \in \mathcal{G}$.

Property: An invariant form on a simple Lie superalgebra \mathcal{G} is either non-degenerate (that is its kernel is zero) or identically zero, and two invariant forms on \mathcal{G} are proportional.

Definition: A bilinear form on \mathcal{G} is called an *inner product* on \mathcal{G} if it is consistent, supersymmetric and invariant.

Definition: The bilinear form associated to the adjoint representation of \mathcal{G} is called the *Killing form* on \mathcal{G} and is denoted $K(X, Y)$:

$$K(X, Y) = \text{str}(\text{ad}(X), \text{ad}(Y)), \quad \forall X, Y \in \mathcal{G}$$

We recall that $\text{ad}(X)Z = \llbracket X, Z \rrbracket$ and $\left(\text{ad}(X_i)\right)_j^k = -C_{ij}^k$ where C_{ij}^k are the structure constants for the basis $\{X_i\}$ of generators of \mathcal{G} . We can therefore write

$$K(X_i, X_j) = (-1)^{\deg X_j} C_{mi}^m C_{nj}^m = g_{ij}$$

Property: The Killing form K of a Lie superalgebra \mathcal{G} is consistent, supersymmetric and invariant (in other words, it is an inner product).

Property: The Killing form K of a Lie superalgebra \mathcal{G} satisfies

$$K(\phi(X), \phi(Y)) = K(X, Y)$$

for all $\phi \in \text{Aut}(\mathcal{G})$ and $X, Y \in \mathcal{G}$.

The following theorems give the fundamental results concerning the Killing form of the (simple) Lie superalgebras:

Theorem:

1. A Lie superalgebra \mathcal{G} with a non-degenerate Killing form is a direct sum of simple Lie superalgebras each having a non-degenerate Killing form.

2. A simple finite dimensional Lie superalgebra \mathcal{G} with a non-degenerate Killing form is of the type $A(m, n)$ where $m \neq n$, $B(m, n)$, $C(n+1)$, $D(m, n)$ where $m \neq n+1$, $F(4)$ or $G(3)$.
3. A simple finite dimensional Lie superalgebra \mathcal{G} with a zero Killing form is of the type $A(n, n)$, $D(n+1, n)$, $D(2, 1; \alpha)$, $P(n)$ or $Q(n)$.

→ Cartan matrices.

For more details, see refs. [21, 22].

24 Lie superalgebra, subalgebra, ideal

Definition: A *Lie superalgebra* \mathcal{G} over a field \mathbb{K} of characteristic zero (usually $\mathbb{K} = \mathbb{R}$ or \mathbb{C}) is a \mathbb{Z}_2 -graded algebra, that is a vector space, direct sum of two vector spaces $\mathcal{G}_{\bar{0}}$ and $\mathcal{G}_{\bar{1}}$, in which a product $\llbracket \cdot, \cdot \rrbracket$, is defined as follows:

- \mathbb{Z}_2 -gradation:

$$\llbracket \mathcal{G}_i, \mathcal{G}_j \rrbracket \subset \mathcal{G}_{i+j \pmod{2}}$$

- graded-antisymmetry:

$$\llbracket X_i, X_j \rrbracket = -(-1)^{\deg X_i \cdot \deg X_j} \llbracket X_j, X_i \rrbracket$$

where $\deg X_i$ is the degree of the vector space. $\mathcal{G}_{\bar{0}}$ is called the even space and $\mathcal{G}_{\bar{1}}$ the odd space. If $\deg X_i \cdot \deg X_j = 0$, the bracket $\llbracket \cdot, \cdot \rrbracket$ defines the usual commutator, otherwise it is an anticommutator.

- generalized Jacobi identity:

$$\begin{aligned} & (-1)^{\deg X_i \cdot \deg X_k} \llbracket X_i, \llbracket X_j, X_k \rrbracket \rrbracket + (-1)^{\deg X_j \cdot \deg X_i} \llbracket X_j, \llbracket X_k, X_i \rrbracket \rrbracket \\ & + (-1)^{\deg X_k \cdot \deg X_j} \llbracket X_k, \llbracket X_i, X_j \rrbracket \rrbracket = 0 \end{aligned}$$

Notice that $\mathcal{G}_{\bar{0}}$ is a Lie algebra – called the even or bosonic part of \mathcal{G} – while $\mathcal{G}_{\bar{1}}$ – called the odd or fermionic part of \mathcal{G} – is not an algebra.

An associative superalgebra $\mathcal{G} = \mathcal{G}_{\bar{0}} \oplus \mathcal{G}_{\bar{1}}$ over the field \mathbb{K} acquires the structure of a Lie superalgebra by taking for the product $\llbracket \cdot, \cdot \rrbracket$ the the *Lie superbracket* or *supercommutator* (also called generalized or graded commutator)

$$\llbracket X, Y \rrbracket = XY - (-1)^{\deg X \cdot \deg Y} YX$$

for two elements $X, Y \in \mathcal{G}$.

Definition: Let $\mathcal{G} = \mathcal{G}_{\bar{0}} \oplus \mathcal{G}_{\bar{1}}$ be a Lie superalgebra.

- A *subalgebra* $\mathcal{K} = \mathcal{K}_{\bar{0}} \oplus \mathcal{K}_{\bar{1}}$ of \mathcal{G} is a subset of elements of \mathcal{G} which forms a vector subspace of \mathcal{G} that is closed with respect to the Lie product of \mathcal{G} such that $\mathcal{K}_{\bar{0}} \subset \mathcal{G}_{\bar{0}}$ and $\mathcal{K}_{\bar{1}} \subset \mathcal{G}_{\bar{1}}$. A subalgebra \mathcal{K} of \mathcal{G} such that $\mathcal{K} \neq \mathcal{G}$ is called a proper subalgebra of \mathcal{G} .
- An *ideal* \mathcal{I} of \mathcal{G} is a subalgebra of \mathcal{G} such that $[[\mathcal{G}, \mathcal{I}]] \subset \mathcal{I}$, that is

$$X \in \mathcal{G}, Y \in \mathcal{I} \Rightarrow [[X, Y]] \in \mathcal{I}$$

An ideal \mathcal{I} of \mathcal{G} such that $\mathcal{I} \neq \mathcal{G}$ is called a proper ideal of \mathcal{G} .

Property: Let \mathcal{G} be a Lie superalgebra and $\mathcal{I}, \mathcal{I}'$ two ideals of \mathcal{G} . Then $[[\mathcal{I}, \mathcal{I}']]$ is an ideal of \mathcal{G} .

25 Matrix realizations of the classical Lie superalgebras

The classical Lie superalgebras can be described as matrix superalgebras as follows. Consider the \mathbb{Z}_2 -graded vector space $\mathcal{V} = \mathcal{V}_{\bar{0}} \oplus \mathcal{V}_{\bar{1}}$ with $\dim \mathcal{V}_{\bar{0}} = m$ and $\dim \mathcal{V}_{\bar{1}} = n$. Then the algebra $End \mathcal{V}$ acquires naturally a superalgebra structure by

$$End \mathcal{V} = End_{\bar{0}} \mathcal{V} \oplus End_{\bar{1}} \mathcal{V} \quad \text{where} \quad End_i \mathcal{V} = \left\{ \phi \in End \mathcal{V} \mid \phi(\mathcal{V}_j) \subset \mathcal{V}_{i+j} \right\}$$

The Lie superalgebra $\ell(m, n)$ is defined as the superalgebra $End \mathcal{V}$ supplied with the Lie superbracket (\rightarrow Lie superalgebras). $\ell(m, n)$ is spanned by matrices of the form

$$M = \begin{pmatrix} A & B \\ C & D \end{pmatrix}$$

where A and D are $gl(m)$ and $gl(n)$ matrices, B and C are $m \times n$ and $n \times m$ rectangular matrices.

One defines on $\ell(m, n)$ the supertrace function denoted by str :

$$str(M) = tr(A) - tr(D)$$

The unitary superalgebra $A(m-1, n-1) = sl(m|n)$ is defined as the superalgebra of matrices $M \in \ell(m, n)$ satisfying the supertrace condition $str(M) = 0$.

In the case $m = n$, $sl(n|n)$ contains a one-dimensional ideal \mathcal{I} generated by \mathbb{I}_{2n} and one sets $A(n-1, n-1) = sl(n|n)/\mathcal{I}$.

The orthosymplectic superalgebra $osp(m, 2n)$ is defined as the superalgebra of matrices $M \in \ell(m, n)$ satisfying the conditions

$$A^t = -A, \quad D^t G = -GD, \quad B = C^t G$$

where t denotes the usual sign of transposition and the matrix G is given by

$$G = \begin{pmatrix} 0 & \mathbb{I}_n \\ -\mathbb{I}_n & 0 \end{pmatrix}$$

The strange superalgebra $P(n)$ is defined as the superalgebra of matrices $M \in \ell(n, n)$ satisfying the conditions

$$A^t = -D, \quad B^t = B, \quad C^t = -C, \quad \text{tr}(A) = 0$$

The strange superalgebra $\tilde{Q}(n)$ is defined as the superalgebra of matrices $M \in \ell(n, n)$ satisfying the conditions

$$A = D, \quad B = C, \quad \text{tr}(B) = 0$$

The superalgebra $\tilde{Q}(n)$ has a one-dimensional center \mathcal{Z} . The simple superalgebra $Q(n)$ is given by $Q(n) = \tilde{Q}(n)/\mathcal{Z}$.

→ Orthosymplectic superalgebras, Strange superalgebras, Unitary superalgebras.
For more details, see refs. [22, 34].

26 Nilpotent and solvable Lie superalgebras

Definition: Let $\mathcal{G} = \mathcal{G}_{\bar{0}} \oplus \mathcal{G}_{\bar{1}}$ be a Lie superalgebra. \mathcal{G} is said *nilpotent* if, considering the series

$$\begin{aligned} \llbracket \mathcal{G}, \mathcal{G} \rrbracket &= \mathcal{G}^{[1]} \\ \llbracket \mathcal{G}, \mathcal{G}^{[1]} \rrbracket &= \mathcal{G}^{[2]} \\ \dots \\ \llbracket \mathcal{G}, \mathcal{G}^{[i-1]} \rrbracket &= \mathcal{G}^{[i]} \end{aligned}$$

then it exists an integer n such that $\mathcal{G}^{[n]} = \{0\}$.

Definition: \mathcal{G} is said *solvable* if, considering the series

$$\begin{aligned} \llbracket \mathcal{G}, \mathcal{G} \rrbracket &= \mathcal{G}^{(1)} \\ \llbracket \mathcal{G}^{(1)}, \mathcal{G}^{(1)} \rrbracket &= \mathcal{G}^{(2)} \\ \dots \\ \llbracket \mathcal{G}^{(i-1)}, \mathcal{G}^{(i-1)} \rrbracket &= \mathcal{G}^{(i)} \end{aligned}$$

then it exists an integer n such that $\mathcal{G}^{(n)} = \{0\}$.

Theorem: The Lie superalgebra \mathcal{G} is solvable if and only if $\mathcal{G}_{\bar{0}}$ is solvable.

Property: Let $\mathcal{G} = \mathcal{G}_{\bar{0}} \oplus \mathcal{G}_{\bar{1}}$ be a solvable Lie superalgebra. Then the irreducible representations of \mathcal{G} are one-dimensional if and only if $\{\mathcal{G}_{\bar{1}}, \mathcal{G}_{\bar{1}}\} \subset [\mathcal{G}_{\bar{0}}, \mathcal{G}_{\bar{0}}]$ – let us recall that in the case of a solvable Lie *algebra*, the irreducible finite dimensional representation are one-dimensional.

Property: Let $\mathcal{G} = \mathcal{G}_{\bar{0}} \oplus \mathcal{G}_{\bar{1}}$ be a solvable Lie superalgebra and let $\mathcal{V} = \mathcal{V}_{\bar{0}} \oplus \mathcal{V}_{\bar{1}}$ be the space of irreducible finite dimensional representations. Then either $\dim \mathcal{V}_{\bar{0}} = \dim \mathcal{V}_{\bar{1}}$ and $\dim \mathcal{V} = 2^s$ with $1 \leq s \leq \dim \mathcal{G}_{\bar{1}}$, or $\dim \mathcal{V} = 1$.

27 Orthosymplectic superalgebras

The orthosymplectic superalgebras form three infinite families of basic Lie superalgebras. The superalgebra $B(m, n)$ or $osp(2m+1|2n)$ defined for $m \geq 0, n \geq 1$ has as even part the Lie algebra $so(2m+1) \oplus sp(2n)$ and as odd part the $(2m+1, 2n)$ representation of the even part; it has rank $m+n$ and dimension $2(m+n)^2 + m + 3n$. The superalgebra $C(n+1)$ or $osp(2|2n)$ where $n \geq 1$ has as even part the Lie algebra $so(2) \oplus sp(2n)$ and the odd part is twice the fundamental representation $(2n)$ of $sp(2n)$; it has rank $n+1$ and dimension $2n^2 + 5n + 1$. The superalgebra $D(m, n)$ or $osp(2m|2n)$ defined for $m \geq 2, n \geq 1$ has as even part the Lie algebra $so(2m) \oplus sp(2n)$ and its odd part is the $(2m, 2n)$ representation of the even part; it has rank $m+n$ and dimension $2(m+n)^2 - m + n$.

The root systems can be expressed in terms of the orthogonal vectors $\varepsilon_1, \dots, \varepsilon_m$ and $\delta_1, \dots, \delta_n$ as follows.

- for $B(m, n)$ with $m \neq 0$:

$$\Delta_{\bar{0}} = \{ \pm \varepsilon_i \pm \varepsilon_j, \pm \varepsilon_i, \pm \delta_i \pm \delta_j, \pm 2\delta_i \} \quad \text{and} \quad \Delta_{\bar{1}} = \{ \pm \varepsilon_i \pm \delta_j, \pm \delta_j \},$$

- for $B(0, n)$:

$$\Delta_{\bar{0}} = \{ \pm \delta_i \pm \delta_j, \pm 2\delta_i \} \quad \text{and} \quad \Delta_{\bar{1}} = \{ \pm \delta_j \},$$

- for $C(n+1)$:

$$\Delta_{\bar{0}} = \{ \pm \delta_i \pm \delta_j, \pm 2\delta_i \} \quad \text{and} \quad \Delta_{\bar{1}} = \{ \pm \varepsilon \pm \delta_j \},$$

- for $D(m, n)$:

$$\Delta_{\bar{0}} = \{ \pm \varepsilon_i \pm \varepsilon_j, \pm \delta_i \pm \delta_j, \pm 2\delta_i \} \quad \text{and} \quad \Delta_{\bar{1}} = \{ \pm \varepsilon_i \pm \delta_j \}.$$

The Dynkin diagrams of the orthosymplectic superalgebras are of the following types:
 - for the superalgebra $B(m, n)$

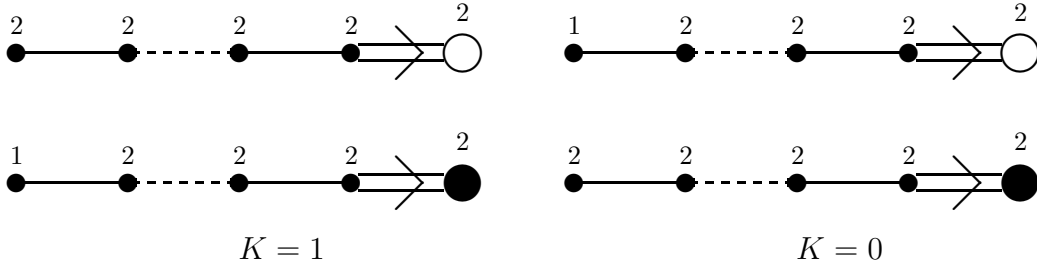

- for the superalgebra $C(n + 1)$

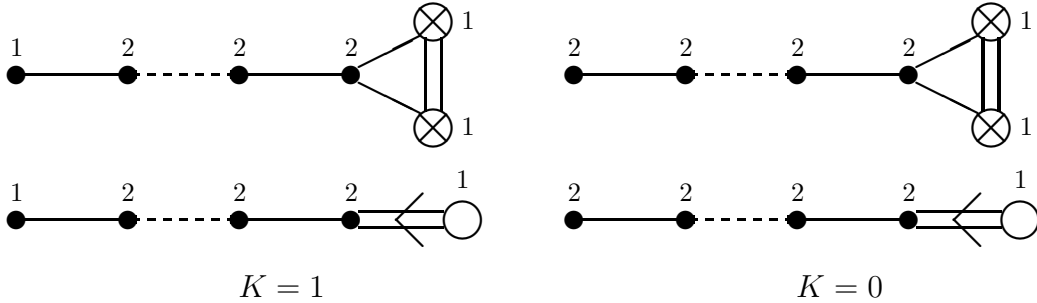

-for the superalgebra $D(m, n)$

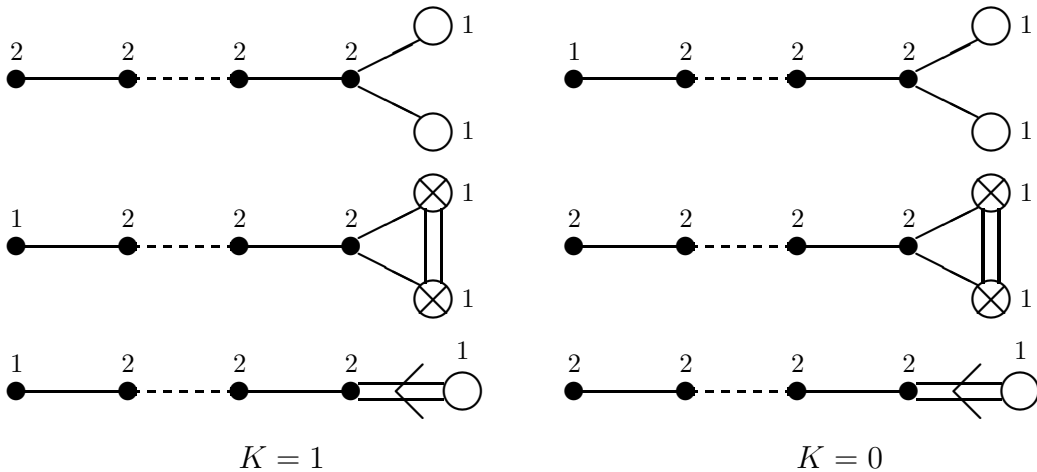

In these diagrams, the labels are the Dynkin labels which give the decomposition of the highest root in terms of the simple roots. The small black dots represent either white dots (associated to even roots) or grey dots (associated to odd roots of zero length), K is the parity of the number of grey dots. The Dynkin diagrams of the orthosymplectic Lie superalgebras up to rank 4 are given in Table 14.

The orthosymplectic superalgebras $osp(M|N)$ (with $M = 2m$ or $2m + 1$ and $N = 2n$) can be generated as matrix superalgebras by taking a basis of $(M + N)^2$ elementary

matrices e_{IJ} of order $M + N$ satisfying $(e_{IJ})_{KL} = \delta_{IL}\delta_{JK}$ ($I, J, K, L = 1, \dots, M + N$). One defines the following graded matrices

$$G_{IJ} = \left(\begin{array}{cc|cc} 0 & \mathbb{I}_m & & 0 \\ \mathbb{I}_m & 0 & & \\ \hline & & 0 & \mathbb{I}_n \\ & & -\mathbb{I}_n & 0 \end{array} \right) \quad \text{if } M = 2m$$

$$G_{IJ} = \left(\begin{array}{ccc|cc} 0 & \mathbb{I}_m & 0 & & \\ \mathbb{I}_m & 0 & 0 & & 0 \\ 0 & 0 & 1 & & \\ \hline & & & 0 & \mathbb{I}_n \\ & & & -\mathbb{I}_n & 0 \end{array} \right) \quad \text{if } M = 2m + 1$$

where \mathbb{I}_m and \mathbb{I}_n are the $m \times m$ and $n \times n$ identity matrices respectively.

Dividing the capital indices I, J, \dots into small unbarred indices i, j, \dots running from 1 to M and small barred indices \bar{i}, \bar{j}, \dots running from $M + 1$ to $M + N$, the generators of $osp(M|N)$ are given by

$$\begin{aligned} E_{ij} &= G_{ik}e_{kj} - G_{jk}e_{ki} \\ E_{\bar{i}\bar{j}} &= G_{\bar{i}\bar{k}}e_{\bar{k}\bar{j}} + G_{\bar{j}\bar{k}}e_{\bar{k}\bar{i}} \\ E_{i\bar{j}} &= E_{\bar{j}i} = G_{ik}e_{k\bar{j}} \end{aligned}$$

Then the E_{ij} (antisymmetric in the indices i, j) generate the $so(M)$ part, the $E_{\bar{i}\bar{j}}$ (symmetric in the indices \bar{i}, \bar{j}) generate the $sp(N)$ part and $E_{i\bar{j}}$ transform as the (M, N) representation of $osp(M|N)$. They satisfy the following (super)commutation relations:

$$\begin{aligned} [E_{ij}, E_{kl}] &= G_{jk}E_{il} + G_{il}E_{jk} - G_{ik}E_{jl} - G_{jl}E_{ik} \\ [E_{\bar{i}\bar{j}}, E_{\bar{k}\bar{l}}] &= -G_{\bar{j}\bar{k}}E_{\bar{i}\bar{l}} - G_{\bar{i}\bar{l}}E_{\bar{j}\bar{k}} - G_{\bar{j}\bar{l}}E_{\bar{i}\bar{k}} - G_{\bar{i}\bar{k}}E_{\bar{j}\bar{l}} \\ [E_{ij}, E_{\bar{k}\bar{l}}] &= 0 \\ [E_{ij}, E_{k\bar{l}}] &= G_{jk}E_{i\bar{l}} - G_{ik}E_{j\bar{l}} \\ [E_{i\bar{j}}, E_{\bar{k}\bar{l}}] &= -G_{\bar{j}\bar{k}}E_{i\bar{l}} - G_{\bar{j}\bar{l}}E_{i\bar{k}} \\ \{E_{i\bar{j}}, E_{k\bar{l}}\} &= G_{ik}E_{\bar{j}\bar{l}} - G_{\bar{j}\bar{l}}E_{ik} \end{aligned}$$

In the case of the superalgebra $osp(1|N)$, the commutation relations greatly simplify. One obtains

$$\begin{aligned} [E_{\bar{i}\bar{j}}, E_{\bar{k}\bar{l}}] &= -G_{\bar{j}\bar{k}}E_{\bar{i}\bar{l}} - G_{\bar{i}\bar{l}}E_{\bar{j}\bar{k}} - G_{\bar{j}\bar{l}}E_{\bar{i}\bar{k}} - G_{\bar{i}\bar{k}}E_{\bar{j}\bar{l}} \\ [E_{\bar{i}}, E_{\bar{j}\bar{k}}] &= -G_{\bar{i}\bar{j}}E_{\bar{k}} - G_{\bar{i}\bar{k}}E_{\bar{j}} \\ \{E_{\bar{i}}, E_{\bar{j}}\} &= E_{\bar{i}\bar{j}} \end{aligned}$$

where $E_{\bar{i}}$ denote the odd generators.

28 Oscillator realizations: Cartan type superalgebras

Oscillator realizations of the Cartan type superalgebras can be obtained as follows. Take a set of $2n$ fermionic oscillators a_i^- and a_i^+ with standard anticommutation relations

$$\{a_i^-, a_j^-\} = \{a_i^+, a_j^+\} = 0 \quad \text{and} \quad \{a_i^+, a_j^-\} = \delta_{ij}$$

In the case of the $W(n)$ superalgebra, one defines the following subspaces:

$$\begin{aligned} \mathcal{G}_{-1} &= \{a_{i_0}^-\} \\ \mathcal{G}_0 &= \{a_{i_0}^+ a_{i_1}^-\} \\ \mathcal{G}_1 &= \{a_{i_0}^+ a_{i_1}^+ a_{i_2}^-\} \quad i_0 \neq i_1 \\ &\dots \\ \mathcal{G}_{n-1} &= \{a_{i_0}^+ a_{i_1}^+ \dots a_{i_{n-1}}^+ a_{i_n}^-\} \quad i_0 \neq i_1 \neq \dots \neq i_{n-1} \end{aligned}$$

the superalgebra $W(n)$ is given by

$$W(n) = \bigoplus_{i=-1}^{n-1} \mathcal{G}_i$$

with \mathbb{Z} -gradation $[\mathcal{G}_i, \mathcal{G}_j] \subset \mathcal{G}_{i+j}$.

In the case of $S(n)$ and $\tilde{S}(n)$, defining the following subspaces:

$$\begin{aligned} \mathcal{G}_{-1} &= \{a_{i_0}^-\} \quad \text{and} \quad \mathcal{G}'_{-1} = \{(1 + a_1^+ \dots a_n^+) a_{i_0}^-\} \\ \mathcal{G}_0 &= \{a_1^+ a_1^- - a_{i_0}^+ a_{i_0}^- \quad (i_0 \neq 1), \quad a_{i_0}^+ a_{i_1}^- \quad (i_1 \neq i_0)\} \\ \mathcal{G}_1 &= \{a_{i_1}^+ (a_1^+ a_1^- - a_{i_0}^+ a_{i_0}^-) \quad (i_1 \neq i_0 \neq 1), \\ &\quad a_1^+ (a_2^+ a_2^- - a_{i_0}^+ a_{i_0}^-) \quad (i_0 \neq 1, 2), \\ &\quad a_{i_2}^+ a_{i_1}^+ a_{i_0}^- \quad (i_2 \neq i_1 \neq i_0)\} \\ \mathcal{G}_2 &= \{a_{i_2}^+ a_{i_1}^+ (a_1^+ a_1^- - a_{i_0}^+ a_{i_0}^-) \quad (i_2 \neq i_1 \neq i_0 \neq 1), \\ &\quad a_{i_1}^+ a_1^+ (a_2^+ a_2^- - a_{i_0}^+ a_{i_0}^-) \quad (i_1 \neq i_0 \neq 1, 2), \\ &\quad a_1^+ a_2^+ (a_3^+ a_3^- - a_{i_0}^+ a_{i_0}^-) \quad (i_0 \neq 1, 2, 3), \\ &\quad a_{i_3}^+ a_{i_2}^+ a_{i_1}^+ a_{i_0}^- \quad (i_3 \neq i_2 \neq i_1 \neq i_0)\} \\ &\dots \end{aligned}$$

the superalgebra $S(n)$ is given by

$$S(n) = \bigoplus_{i=0}^{n-2} \mathcal{G}_i \oplus \mathcal{G}_{-1}$$

and the superalgebra $\tilde{S}(n)$ by

$$\tilde{S}(n) = \bigoplus_{i=0}^{n-2} \mathcal{G}_i \oplus \mathcal{G}'_{-1}$$

Finally, in the case of $H(n)$ one defines the following subspaces:

$$\begin{aligned} \mathcal{G}_{-1} &= \{a_{i_0}^-\} \\ \mathcal{G}_0 &= \{a_{i_0}^+ a_{i_1}^- - a_{i_1}^+ a_{i_0}^-\} \\ \mathcal{G}_1 &= \{a_{i_0}^+ a_{i_1}^+ a_{i_2}^- - a_{i_0}^+ a_{i_2}^+ a_{i_1}^- - a_{i_2}^+ a_{i_0}^+ a_{i_1}^- + a_{i_1}^+ a_{i_2}^+ a_{i_0}^- + a_{i_2}^+ a_{i_0}^+ a_{i_1}^- - a_{i_2}^+ a_{i_1}^+ a_{i_0}^-\} \\ &\dots \end{aligned}$$

The superalgebra $H(n)$ is given by

$$H(n) = \bigoplus_{i=-1}^{n-3} \mathcal{G}_i$$

For more details, see ref. [34].

29 Oscillator realizations: orthosymplectic and unitary series

Let us consider a set of $2n$ bosonic oscillators b_i^- and b_i^+ with commutation relations:

$$[b_i^-, b_j^-] = [b_i^+, b_j^+] = 0 \quad \text{and} \quad [b_i^-, b_j^+] = \delta_{ij}$$

and a set of $2m$ fermionic oscillators a_i^- and a_i^+ with anticommutation relations:

$$\{a_i^-, a_j^-\} = \{a_i^+, a_j^+\} = 0 \quad \text{and} \quad \{a_i^-, a_j^+\} = \delta_{ij}$$

the two sets commuting each other:

$$[b_i^-, a_j^-] = [b_i^-, a_j^+] = [b_i^+, a_j^-] = [b_i^+, a_j^+] = 0$$

Oscillator realization of $A(m-1, n-1)$

Let

$$\Delta = \left\{ \varepsilon_i - \varepsilon_j, \delta_i - \delta_j, \varepsilon_i - \delta_j, -\varepsilon_i + \delta_j \right\}$$

be the root system of $A(m-1, n-1)$ expressed in terms of the orthogonal vectors $\varepsilon_1, \dots, \varepsilon_m$ and $\delta_1, \dots, \delta_n$. An oscillator realization of the simple generators in the distinguished basis is given by

$$\begin{aligned} H_i &= b_i^+ b_i^- - b_{i+1}^+ b_{i+1}^- & E_{\delta_i - \delta_{i+1}} &= b_i^+ b_{i+1}^- & E_{\delta_{i+1} - \delta_i} &= b_{i+1}^+ b_i^- & (1 \leq i \leq n-1) \\ H_n &= b_{n+1}^+ b_{n+1}^- + a_1^+ a_1^- & E_{\delta_n - \varepsilon_1} &= b_n^+ a_1^- & E_{\varepsilon_1 - \delta_n} &= a_1^+ b_n^- \\ H_{n+i} &= a_i^+ a_i^- - a_{i+1}^+ a_{i+1}^- & E_{\varepsilon_i - \varepsilon_{i+1}} &= a_i^+ a_{i+1}^- & E_{\varepsilon_{i+1} - \varepsilon_i} &= a_{i+1}^+ a_i^- & (1 \leq i \leq m-1) \end{aligned}$$

By commutation relation, one finds the realization of the whole set of root generators:

$$\begin{aligned} E_{\varepsilon_i - \varepsilon_j} &= a_i^+ a_j^- & E_{\delta_i - \delta_j} &= b_i^+ b_j^- \\ E_{\varepsilon_i - \delta_j} &= a_i^+ b_j^- & E_{-\varepsilon_i + \delta_j} &= a_i^- b_j^+ \end{aligned}$$

Oscillator realization of $B(m, n)$

Let

$$\Delta = \left\{ \pm \varepsilon_i \pm \varepsilon_j, \pm \varepsilon_i, \pm \delta_i \pm \delta_j, \pm 2\delta_i, \pm \varepsilon_i \pm \delta_j, \pm \delta_i \right\}$$

be the root system of $B(m, n)$ expressed in terms of the orthogonal vectors $\varepsilon_1, \dots, \varepsilon_m$ and $\delta_1, \dots, \delta_n$. An oscillator realization of the simple generators in the distinguished basis is given by

$$\begin{aligned} H_i &= b_i^+ b_i^- - b_{i+1}^+ b_{i+1}^- & E_{\delta_i - \delta_{i+1}} &= b_i^+ b_{i+1}^- & E_{\delta_{i+1} - \delta_i} &= b_{i+1}^+ b_i^- & (1 \leq i \leq n-1) \\ H_n &= b_n^+ b_n^- + a_1^+ a_1^- & E_{\delta_n - \varepsilon_1} &= b_n^+ a_1^- & E_{\varepsilon_1 - \delta_n} &= a_1^+ b_n^- \\ H_{n+i} &= a_i^+ a_i^- - a_{i+1}^+ a_{i+1}^- & E_{\varepsilon_i - \varepsilon_{i+1}} &= a_i^+ a_{i+1}^- & E_{\varepsilon_{i+1} - \varepsilon_i} &= a_{i+1}^+ a_i^- & (1 \leq i \leq m-1) \\ H_{n+m} &= 2a_m^+ a_m^- - 1 & E_{\varepsilon_m}^+ &= (-1)^N a_m^+ & E_{\varepsilon_m}^- &= a_m^- (-1)^N \end{aligned}$$

where $N = \sum_{k=1}^m a_k^+ a_k^-$.

By commutation relation, one finds the realization of the whole set of root generators:

$$\begin{aligned} E_{\pm \varepsilon_i \pm \varepsilon_j} &= a_i^\pm a_j^\pm & E_{\pm \varepsilon_i \pm \delta_j} &= a_i^\pm b_j^\pm \\ E_{\pm \delta_i \pm \delta_j} &= b_i^\pm b_j^\pm & E_{\pm 2\delta_i} &= (b_i^\pm)^2 \\ E_{\varepsilon_i} &= (-1)^N a_i^+ & E_{-\varepsilon_i} &= a_i^- (-1)^N \\ E_{\delta_i} &= (-1)^N b_i^+ & E_{-\delta_i} &= b_i^- (-1)^N \end{aligned}$$

Oscillator realization of $B(0, n)$

The case $B(0, n)$ requires special attention. The root system of $B(0, n)$ can be expressed in terms of the orthogonal vectors $\delta_1, \dots, \delta_n$ and reduces to

$$\Delta = \left\{ \pm \delta_i \pm \delta_j, \pm 2\delta_i, \pm \delta_i \right\}$$

An oscillator realization of the generators of $B(0, n)$ can be obtained only with the help of bosonic oscillators. It is given for the simple generators by

$$\begin{aligned} H_i &= b_i^+ b_i^- - b_{i+1}^+ b_{i+1}^- & E_{\delta_i - \delta_{i+1}} &= b_i^+ b_{i+1}^- & E_{\delta_{i+1} - \delta_i} &= b_{i+1}^+ b_i^- & (1 \leq i \leq n-1) \\ H_n &= b_n^+ b_n^- + \frac{1}{2} & E_{\delta_n} &= b_n^+ & E_{-\delta_n} &= b_n^- \end{aligned}$$

By commutation relation, one finds the realization of the whole set of root generators:

$$E_{\pm \delta_i \pm \delta_j} = b_i^\pm b_j^\pm \quad E_{\pm 2\delta_i} = (b_i^\pm)^2 \quad E_{\pm \delta_i} = \frac{1}{\sqrt{2}} b_i^\pm$$

Oscillator realization of $C(n+1)$

Let

$$\Delta = \left\{ \pm \delta_i \pm \delta_j, \pm 2\delta_i, \pm \varepsilon \pm \delta_j \right\}$$

be the root system of $C(n+1)$ expressed in terms of the orthogonal vectors $\varepsilon, \delta_1, \dots, \delta_n$. An oscillator realization of the simple generators in the distinguished basis is given by

$$\begin{aligned} H_1 &= a_1^+ a_1^- + b_1^+ b_1^- & E_{\varepsilon - \delta_1} &= a_1^+ b_1^- & E_{\delta_1 - \varepsilon} &= b_1^+ a_1^- \\ H_i &= b_i^+ b_i^- - b_{i+1}^+ b_{i+1}^- & E_{\delta_i - \delta_{i+1}} &= b_i^+ b_{i+1}^- & E_{\delta_{i+1} - \delta_i} &= b_{i+1}^+ b_i^- \quad (2 \leq i \leq n) \\ H_{n+1} &= b_n^+ b_n^- + 1/2 & E_{2\delta_n} &= \frac{1}{2}(b_n^+)^2 & E_{-2\delta_n} &= \frac{1}{2}(b_n^-)^2 \end{aligned}$$

By commutation relation, one finds the realization of the whole set of root generators:

$$\begin{aligned} E_{\pm \delta_i \pm \delta_j} &= b_i^\pm b_j^\pm & E_{\pm 2\delta_i} &= (b_i^\pm)^2/2 \\ E_{\varepsilon \pm \delta_j} &= a_1^\pm b_j^\pm & E_{-\varepsilon \pm \delta_j} &= b_j^\pm a_1^\mp \end{aligned}$$

Oscillator realization of $D(m, n)$

Let

$$\Delta = \left\{ \pm \varepsilon_i \pm \varepsilon_j, \pm \delta_i \pm \delta_j, \pm 2\delta_i, \pm \varepsilon_i \pm \delta_j \right\}$$

be the root system of $D(m, n)$ expressed in terms of the orthogonal vectors $\varepsilon_1, \dots, \varepsilon_m$ and $\delta_1, \dots, \delta_n$. An oscillator realization of the simple generators in the distinguished basis is given by

$$\begin{aligned} H_i &= b_i^+ b_i^- - b_{i+1}^+ b_{i+1}^- & E_{\delta_i - \delta_{i+1}} &= b_i^+ b_{i+1}^- & E_{\delta_{i+1} - \delta_i} &= b_{i+1}^+ b_i^- & (1 \leq i \leq n-1) \\ H_n &= b_n^+ b_n^- + a_1^+ a_1^- & E_{\delta_n - \varepsilon_1} &= b_n^+ a_1^- & E_{\varepsilon_1 - \delta_n} &= a_1^+ b_n^- \\ H_{n+i} &= a_i^+ a_i^- - a_{i+1}^+ a_{i+1}^- & E_{\varepsilon_i - \varepsilon_{i+1}} &= a_i^+ a_{i+1}^- & E_{\varepsilon_{i+1} - \varepsilon_i} &= a_{i+1}^+ a_i^- & (1 \leq i \leq m-1) \\ H_{n+m} &= a_{m-1}^+ a_{m-1}^- + a_m^+ a_m^- - 1 & E_{\varepsilon_{m-1} + \varepsilon_m} &= a_m^+ a_{m-1}^- & E_{-\varepsilon_m - \varepsilon_{m-1}} &= a_{m-1}^- a_m^- \end{aligned}$$

By commutation relation, one finds the realization of the whole set of root generators:

$$\begin{aligned} E_{\pm \varepsilon_i \pm \varepsilon_j} &= a_i^\pm a_j^\pm & E_{\pm \varepsilon_i \pm \delta_j} &= a_i^\pm b_j^\pm \\ E_{\pm \delta_i \pm \delta_j} &= b_i^\pm b_j^\pm & E_{\pm 2\delta_i} &= (b_i^\pm)^2 \end{aligned}$$

For more details, see refs. [4, 45]. Note that in ref. [4], oscillator realizations were used to analyse supersymmetric structure in the spectra of complex nuclei; the first reference of this interesting approach is [17].

30 Oscillator realizations: strange series

Let us consider a set of $2n$ bosonic oscillators b_i^- and b_i^+ with commutation relations:

$$[b_i^-, b_j^-] = [b_i^+, b_j^+] = 0 \quad \text{and} \quad [b_i^-, b_j^+] = \delta_{ij}$$

and a set of $2n$ fermionic oscillators a_i^- and a_i^+ with anticommutation relations:

$$\{a_i^-, a_j^-\} = \{a_i^+, a_j^+\} = 0 \quad \text{and} \quad \{a_i^-, a_j^+\} = \delta_{ij}$$

the two sets commuting each other:

$$[b_i^-, a_j^-] = [b_i^-, a_j^+] = [b_i^+, a_j^-] = [b_i^+, a_j^+] = 0$$

Oscillator realization of $P(n)$

An oscillator realization of the generators of $P(n)$ is obtained as follows:

- the generators of the even $sl(n)$ part are given by

$$\begin{aligned} H_i &= a_i^+ a_i^- - a_{i+1}^+ a_{i+1}^- + b_i^+ b_i^- - b_{i+1}^+ b_{i+1}^- \quad \text{with} \quad 1 \leq i \leq n-1 \\ E_{ij}^+ &= a_i^+ a_j^- + b_i^+ b_j^- \quad \text{with} \quad 1 \leq i < j \leq n \\ E_{ij}^- &= a_i^+ a_j^- + b_i^+ b_j^- \quad \text{with} \quad 1 \leq j < i \leq n \end{aligned}$$

- the generators of the odd symmetric part \mathcal{G}_S of $P(n)$ by

$$\begin{aligned} F_{ij}^+ &= b_i^+ a_j^+ + b_j^+ a_i^+ \quad \text{with} \quad 1 \leq i \neq j \leq n \\ F_i^+ &= b_i^+ b_i^+ \quad \text{with} \quad 1 \leq i \leq n \end{aligned}$$

- the generators of the odd antisymmetric part \mathcal{G}_A of $P(n)$ by

$$F_{ij}^- = b_i^- a_j^- + b_j^- a_i^- \quad \text{with} \quad 1 \leq i \neq j \leq n$$

Oscillator realization of $Q(n)$

An oscillator realization of the generators of $Q(n)$ is obtained as follows:

- the generators of the even $sl(n)$ part are given by

$$\begin{aligned} H_i &= a_i^+ a_i^- - a_{i+1}^+ a_{i+1}^- + b_i^+ b_i^- - b_{i+1}^+ b_{i+1}^- \\ E_{ij} &= a_i^+ a_j^- + b_i^+ b_j^- \end{aligned}$$

- the generator of the $U(1)$ part by

$$Z = \sum_{i=1}^n a_i^+ a_i^- + b_i^+ b_i^-$$

- the generators of the odd $sl(n)$ part by

$$\begin{aligned} K_i &= a_i^+ b_i^- - a_{i+1}^+ b_{i+1}^- + b_i^+ a_i^- - b_{i+1}^+ a_{i+1}^- \\ F_{ij} &= a_i^+ b_j^- + b_i^+ a_j^- \end{aligned}$$

For more details, see ref. [11].

31 Real forms

Definition: Let \mathcal{G} be a classical Lie superalgebra over \mathbb{C} . A semimorphism ϕ of \mathcal{G} is a semilinear transformation of \mathcal{G} which preserves the gradation, that is such that

$$\begin{aligned}\phi(X + Y) &= \phi(X) + \phi(Y) \\ \phi(\alpha X) &= \bar{\alpha}\phi(X) \\ \llbracket \phi(X), \phi(Y) \rrbracket &= \phi(\llbracket X, Y \rrbracket)\end{aligned}$$

for all $X, Y \in \mathcal{G}$ and $\alpha \in \mathbb{C}$.

If ϕ is an involutive semimorphism of \mathcal{G} , the superalgebra $\mathcal{G}^\phi = \{X + \phi(X) \mid X \in \mathcal{G}\}$ is a real classical Lie superalgebra. Moreover, two involutive semimorphisms ϕ and ϕ' of \mathcal{G} being given, the real forms \mathcal{G}^ϕ and $\mathcal{G}^{\phi'}$ are isomorphic if and only if ϕ and ϕ' are conjugate by an automorphism (\rightarrow) of \mathcal{G} .

It follows that the real classical Lie superalgebras are either the complex classical Lie superalgebras regarded as real superalgebras or the real forms obtained as sub-superalgebras of fixed points of the involutive semimorphisms of a complex classical Lie superalgebra. The real forms of a complex classical Lie superalgebra \mathcal{G} are thus classified by the involutive semimorphisms of \mathcal{G} in the automorphism group of \mathcal{G} . One can prove that the real forms of the complex classical Lie superalgebras are uniquely determined by the real forms \mathcal{G}_0^ϕ of the even part \mathcal{G}_0 of \mathcal{G} . They are displayed in Table 16.

Notice that m, n have to be even for $sl(m|n, \mathbb{H})$, $sl(n|n, \mathbb{H})$ and $HQ(n)$. We recall that $su^*(2n)$ is the set of $2n \times 2n$ matrices of the form $\begin{pmatrix} X_n & Y_n \\ -Y_n^* & X_n^* \end{pmatrix}$ such that X_n, Y_n are matrices of order n and $\text{tr}(X_n) + \text{tr}(X_n^*) = 0$ and $so^*(2n)$ is the set of $2n \times 2n$ matrices of the form $\begin{pmatrix} X_n & Y_n \\ -Y_n^* & X_n^* \end{pmatrix}$ such that X_n and Y_n are antisymmetric and hermitian complex matrices of order n respectively.

For more details, see refs. [21, 32].

32 Representations: basic definitions

Definition: Let $\mathcal{G} = \mathcal{G}_0 \oplus \mathcal{G}_1$ be a classical Lie superalgebra. Let $\mathcal{V} = \mathcal{V}_0 \oplus \mathcal{V}_1$ be a \mathbb{Z}_2 -graded vector space and consider the superalgebra $End\mathcal{V} = End_0\mathcal{V} \oplus End_1\mathcal{V}$ of endomorphisms of \mathcal{V} . A linear representation π of \mathcal{G} is a homomorphism of \mathcal{G} into $End\mathcal{V}$, that is, $\llbracket \cdot, \cdot \rrbracket$ denoting the superbracket,

$$\pi(\alpha X) = \alpha\pi(X) \quad \text{and} \quad \pi(X + Y) = \pi(X) + \pi(Y)$$

$$\begin{aligned}\pi(\llbracket X, Y \rrbracket) &= \llbracket \pi(X), \pi(Y) \rrbracket \\ \pi(\mathcal{G}_0) &\subset \text{End}_0 \mathcal{V} \quad \text{and} \quad \pi(\mathcal{G}_1) \subset \text{End}_1 \mathcal{V}\end{aligned}$$

for all $X, Y \in \mathcal{G}$ and $\alpha \in \mathbb{C}$.

The vector space \mathcal{V} is the representation space. The vector space \mathcal{V} has the structure of a \mathcal{G} -module by $X(\vec{v}) = \pi(X)\vec{v}$ for $X \in \mathcal{G}$ and $\vec{v} \in \mathcal{V}$.

The dimension (resp. superdimension) of the representation π is the dimension (resp. graded dimension) of the vector space \mathcal{V} :

$$\begin{aligned}\dim \pi &= \dim \mathcal{V}_0 + \dim \mathcal{V}_1 \\ \text{sdim } \pi &= \dim \mathcal{V}_0 - \dim \mathcal{V}_1\end{aligned}$$

Definition: The representation π is said

- faithful if $\pi(X) \neq 0$ for all $X \in \mathcal{G}$.
- trivial if $\pi(X) = 0$ for all $X \in \mathcal{G}$.

Every classical Lie superalgebra has a finite dimensional faithful representation.

In particular, the representation $\text{ad} : \mathcal{G} \rightarrow \text{End } \mathcal{G}$ (\mathcal{G} being considered as a \mathbb{Z}_2 -graded vector space) such that $\text{ad}(X)Y = \llbracket X, Y \rrbracket$ is called the *adjoint* representation of \mathcal{G} .

33 Representations: exceptional superalgebras

33.1 Representations of $F(4)$

A highest weight irreducible representation of $F(4)$ is characterized by its Dynkin labels (\rightarrow Highest weight representations) drawn on the distinguished Dynkin diagram:

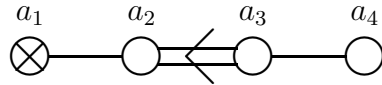

where a_2, a_3, a_4 are positive or null integers.

For the $so(7)$ part, a_2 is the shorter root. The $sl(2)$ representation label is hidden by the odd root and its value is given by $b = \frac{1}{3}(2a_1 - 3a_2 - 4a_3 - 2a_4)$. Since b has to be a non-negative integer, this relation implies a_1 to be a positive integer or half-integer. Finally, a $F(4)$ representation with $b < 4$ has to satisfy a consistency condition, that is

$$\begin{aligned}b = 0 & \quad a_1 = a_2 = a_3 = a_4 = 0 \\ b = 1 & \quad \text{not possible} \\ b = 2 & \quad a_2 = a_4 = 0 \\ b = 3 & \quad a_2 = 2a_4 + 1\end{aligned}$$

The eight atypicality conditions for the $F(4)$ representations are the following:

$$\begin{array}{ll}
a_1 = 0 & \text{or} \quad b = 0 \\
a_1 = a_2 + 1 & \text{or} \quad b = \frac{1}{3}(2 - a_2 - 4a_3 - 2a_4) \\
a_1 = a_2 + 2a_3 + 3 & \text{or} \quad b = \frac{1}{3}(6 - a_2 - 2a_4) \\
a_1 = a_2 + 2a_3 + 2a_4 + 5 & \text{or} \quad b = \frac{1}{3}(10 - a_2 + 2a_4) \\
a_1 = 2a_2 + 2a_3 + 4 & \text{or} \quad b = \frac{1}{3}(8 + a_2 - 2a_4) \\
a_1 = 2a_2 + 2a_3 + 2a_4 + 6 & \text{or} \quad b = \frac{1}{3}(12 + a_2 + 2a_4) \\
a_1 = 2a_2 + 4a_3 + 2a_4 + 8 & \text{or} \quad b = \frac{1}{3}(16 + a_2 + 4a_3 + 2a_4) \\
a_1 = 3a_2 + 4a_3 + 2a_4 + 9 & \text{or} \quad b = \frac{1}{3}(18 + 3a_2 + 4a_3 + 2a_4)
\end{array}$$

Moreover, a necessary (but not sufficient) condition for a representation to be typical is that $b \geq 4$.

The dimension of a typical representation with highest weight $\Lambda = (a_1, a_2, a_3, a_4)$ is given by

$$\dim \mathcal{V}(\Lambda) = \frac{32}{45}(a_2 + 1)(a_3 + 1)(a_4 + 1)(a_2 + a_3 + 2)(a_3 + a_4 + 2)(a_2 + 2a_3 + 3) \\
(a_2 + a_3 + a_4 + 3)(a_2 + 2a_3 + 2a_4 + 5)(a_2 + 2a_3 + a_4 + 4)(2a_1 - 3a_2 - 4a_3 - 2a_4 - 9)$$

For more details, see refs. [24, 41].

33.2 Representations of $G(3)$

A highest weight irreducible representation of $G(3)$ is characterized by its Dynkin labels (\rightarrow Highest weight representations) drawn on the distinguished Dynkin diagram:

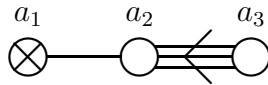

where a_2, a_3 are positive or null integers.

For the $G(2)$ part, a_2 is the shorter root. The $sl(2)$ representation label is hidden by the odd root and its value is given by $b = \frac{1}{2}(a_1 - 2a_2 - 3a_3)$. Since b has to be a non-negative integer, this relation implies a_1 to be a positive integer. Finally, a $G(3)$ representation with $b < 3$ has to satisfy a consistency condition, that is

$$\begin{array}{ll}
b = 0 & a_1 = a_2 = a_3 = 0 \\
b = 1 & \text{not possible} \\
b = 2 & a_2 = 0
\end{array}$$

The six atypicality conditions for the $G(3)$ representations are the following:

$$\begin{array}{ll}
a_1 = 0 & \text{or} \quad b = 0 \\
a_1 = a_2 + 1 & \text{or} \quad b = \frac{1}{2}(1 - a_2 - 3a_3) \\
a_1 = a_2 + 3a_3 + 4 & \text{or} \quad b = \frac{1}{2}(4 - a_2) \\
a_1 = 3a_2 + 3a_3 + 6 & \text{or} \quad b = \frac{1}{2}(6 + a_2) \\
a_1 = 3a_2 + 6a_3 + 9 & \text{or} \quad b = \frac{1}{2}(4 + a_2 + 3a_3) \\
a_1 = 4a_2 + 6a_3 + 10 & \text{or} \quad b = \frac{1}{2}(10 + 2a_2 + 3a_3)
\end{array}$$

Let us remark that the first condition corresponds to the trivial representation and the second one is never satisfied.

Moreover, a necessary (but not sufficient) condition for a representation to be typical is that $b \geq 3$.

The dimension of a typical representation with highest weight $\Lambda = (a_1, a_2, a_3)$ is given by

$$\dim \mathcal{V}(\Lambda) = \frac{8}{15}(a_2 + 1)(a_3 + 1)(a_2 + a_3 + 2)(a_2 + 3a_3 + 4)(a_2 + 2a_3 + 3) \\
(2a_2 + 3a_3 + 5)(a_1 - 2a_2 - 3a_3 - 5)$$

For more details, see refs. [24, 42].

33.3 Representations of $D(2, 1; \alpha)$

A highest weight irreducible representation of $D(2, 1; \alpha)$ is characterized by its Dynkin labels (\rightarrow Highest weight representations) drawn on the distinguished Dynkin diagram:

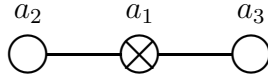

where a_2, a_3 are positive or null integers.

The $sl(2)$ representation label is hidden by the odd root and its value is given by $b = \frac{1}{1+\alpha}(2a_1 - a_2 - \alpha a_3)$, which has to be a non-negative integer. Finally, a $D(2, 1; \alpha)$ representation with $b < 2$ has to satisfy a consistency condition, that is

$$\begin{array}{ll}
b = 0 & a_1 = a_2 = a_3 = 0 \\
b = 1 & \alpha(a_3 + 1) = \pm(a_2 + 1)
\end{array}$$

The four atypicality conditions for the $D(2, 1; \alpha)$ representations are the following:

$$\begin{array}{ll}
a_1 = 0 & \text{or} \quad b = 0 \\
a_1 = a_2 + 1 & \text{or} \quad b = \frac{1}{1+\alpha}(2 + 2a_2 - \alpha a_3) \\
a_1 = \alpha(a_3 + 1) & \text{or} \quad b = \frac{1}{1+\alpha}(2\alpha - a_2 - \alpha a_3) \\
a_1 = a_2 + \alpha a_3 + 1 + \alpha & \text{or} \quad b = \frac{1}{1+\alpha}(2 + 2\alpha + a_2 + \alpha a_3)
\end{array}$$

The dimension of a typical representation with highest weight $\Lambda = (a_1, a_2, a_3)$ is given by

$$\dim \mathcal{V}(\Lambda) = \frac{16}{1+\alpha} (a_2 + 1)(a_3 + 1)(2a_1 - a_2 - \alpha a_3 - 1 - \alpha)$$

For more details, see refs. [24, 47].

34 Representations: highest weight representations

Let $\mathcal{G} = \mathcal{G}_{\bar{0}} \oplus \mathcal{G}_{\bar{1}}$ be a basic Lie superalgebra with Cartan subalgebra \mathcal{H} and \mathcal{H}^* be the dual of \mathcal{H} . We assume that $\mathcal{G} \neq A(n, n)$ but the following results still hold for $sl(n+1|n+1)$. Let $\mathcal{G} = \mathcal{N}^+ \oplus \mathcal{H} \oplus \mathcal{N}^-$ be a Borel decomposition of \mathcal{G} where \mathcal{N}^+ (resp. \mathcal{N}^-) is spanned by the positive (resp. negative) root generators of \mathcal{G} (\rightarrow Simple root systems).

Definition: A representation $\pi : \mathcal{G} \rightarrow \text{End } \mathcal{V}$ with representation space \mathcal{V} is called a *highest weight* representation with highest weight $\Lambda \in \mathcal{H}^*$ if there exists a non-zero vector $\vec{v}_\Lambda \in \mathcal{V}$ such that

$$\begin{aligned} \mathcal{N}^+ \vec{v}_\Lambda &= 0 \\ h(\vec{v}_\Lambda) &= \Lambda(h) \vec{v}_\Lambda \quad (h \in \mathcal{H}) \end{aligned}$$

The \mathcal{G} -module \mathcal{V} is called a highest weight module, denoted by $\mathcal{V}(\Lambda)$, and the vector $\vec{v}_\Lambda \in \mathcal{V}$ a highest weight vector.

From now on, \mathcal{H} is the *distinguished* Cartan subalgebra (\rightarrow) of \mathcal{G} with basis of generators (H_1, \dots, H_r) where $r = \text{rank } \mathcal{G}$ and H_s denotes the Cartan generator associated to the odd simple root. The Dynkin labels are defined by

$$a_i = 2 \frac{(\Lambda, \alpha_i)}{(\alpha_i, \alpha_i)} \text{ for } i \neq s \quad \text{and} \quad a_s = (\Lambda, \alpha_s)$$

A weight $\Lambda \in \mathcal{H}^*$ is called a dominant weight if $a_i \geq 0$ for all $i \neq s$, integral if $a_i \in \mathbb{Z}$ for all $i \neq s$ and integral dominant if $a_i \in \mathbb{N}$ for all $i \neq s$.

Property: A necessary condition for the highest weight representation of \mathcal{G} with highest weight Λ to be finite dimensional is that Λ be an integral dominant weight.

Following Kac (see ref. [24]), one defines the Kac module:

Definition: Let \mathcal{G} be a basic Lie superalgebra with the distinguished \mathbb{Z} -gradation $\mathcal{G} = \bigoplus_{i \in \mathbb{Z}} \mathcal{G}_i$ (\rightarrow Classical Lie superalgebras). Let $\Lambda \in \mathcal{H}^*$ be an integral dominant weight and $\mathcal{V}_0(\Lambda)$ be the \mathcal{G}_0 -module with highest weight $\Lambda \in \mathcal{H}^*$. Consider the \mathcal{G} -subalgebra $\mathcal{K} = \mathcal{G}_0 \oplus \mathcal{N}^+$ where $\mathcal{N}^+ = \bigoplus_{i > 0} \mathcal{G}_i$. The \mathcal{G}_0 -module $\mathcal{V}_0(\Lambda)$ is extended to a \mathcal{K} -module by

setting $\mathcal{N}^+\mathcal{V}_0(\Lambda) = 0$. The Kac module $\bar{\mathcal{V}}(\Lambda)$ is defined as follows:

i) if the superalgebra \mathcal{G} is of type I (the odd part is the direct sum of two irreducible representations of the even part), the Kac module is the induced module (\rightarrow Representations: induced modules)

$$\bar{\mathcal{V}}(\Lambda) = \text{Ind}_{\mathcal{K}}^{\mathcal{G}} \mathcal{V}_0(\Lambda)$$

ii) if the superalgebra \mathcal{G} is of type II (the odd part is an irreducible representation of the even part), the induced module $\text{Ind}_{\mathcal{K}}^{\mathcal{G}} \mathcal{V}_0(\Lambda)$ contains a submodule $\mathcal{M}(\Lambda) = \mathcal{U}(\mathcal{G})\mathcal{G}_{-\psi}^{b+1}\mathcal{V}_0(\Lambda)$ where ψ is the longest simple root of \mathcal{G}_0 which is hidden behind the odd simple root (that is the longest simple root of $sp(2n)$ in the case of $osp(m|2n)$ and the simple root of $sl(2)$ in the case of $F(4)$, $G(3)$ and $D(2, 1; \alpha)$) and $b = 2(\Lambda, \psi)/(\psi, \psi)$ is the component of Λ with respect to ψ (\rightarrow Representations: orthosymplectic superalgebras, exceptional superalgebras for explicit expressions of b). The Kac module is then defined as the quotient of the induced module $\text{Ind}_{\mathcal{K}}^{\mathcal{G}} \mathcal{V}_0(\Lambda)$ by the submodule $\mathcal{M}(\Lambda)$:

$$\bar{\mathcal{V}}(\Lambda) = \text{Ind}_{\mathcal{K}}^{\mathcal{G}} \mathcal{V}_0(\Lambda) / \mathcal{U}(\mathcal{G})\mathcal{G}_{-\psi}^{b+1}\mathcal{V}_0(\Lambda)$$

In case the Kac module is not simple, it contains a maximal submodule $\mathcal{I}(\Lambda)$ and the quotient module $\mathcal{V}(\Lambda) = \bar{\mathcal{V}}(\Lambda)/\mathcal{I}(\Lambda)$ is a simple module.

The fundamental result concerning the representations of basic Lie superalgebras is the following:

Theorem:

- Any finite dimensional irreducible representation of \mathcal{G} is of the form $\mathcal{V}(\Lambda) = \bar{\mathcal{V}}(\Lambda)/\mathcal{I}(\Lambda)$ where Λ is an integral dominant weight.
- Any finite dimensional simple \mathcal{G} -module is uniquely characterized by its integral dominant weight Λ : two \mathcal{G} -modules $\mathcal{V}(\Lambda)$ and $\mathcal{V}(\Lambda')$ are isomorphic if and only if $\Lambda = \Lambda'$.
- The finite dimensional simple \mathcal{G} -module $\mathcal{V}(\Lambda) = \bar{\mathcal{V}}(\Lambda)/\mathcal{I}(\Lambda)$ has the weight decomposition

$$\mathcal{V}(\Lambda) = \bigoplus_{\lambda \leq \Lambda} \mathcal{V}_\lambda \quad \text{with} \quad \mathcal{V}_\lambda = \{ \vec{v} \in \mathcal{V} \mid h(\vec{v}) = \lambda(h)\vec{v}, h \in \mathcal{H} \}$$

35 Representations: induced modules

The method of induced representations is an elegant and powerful way to construct the highest weight representations (\rightarrow) of the basic Lie superalgebras. This section is

quite formal compared to the rest of the text but is fundamental for the representation theory of the Lie superalgebras.

Let \mathcal{G} be a basic Lie superalgebra and \mathcal{K} be a subalgebra of \mathcal{G} . Denote by $\mathcal{U}(\mathcal{G})$ and $\mathcal{U}(\mathcal{K})$ the corresponding universal enveloping superalgebras (\rightarrow). From a \mathcal{K} -module \mathcal{V} , it is possible to construct a \mathcal{G} -module in the following way. The vector space \mathcal{V} is naturally extended to a $\mathcal{U}(\mathcal{K})$ -module. One considers the factor space $\mathcal{U}(\mathcal{G}) \otimes_{\mathcal{U}(\mathcal{K})} \mathcal{V}$ consisting of elements of $\mathcal{U}(\mathcal{G}) \otimes \mathcal{V}$ such that the elements $h \otimes \vec{v}$ and $1 \otimes h(\vec{v})$ have been identified for $h \in \mathcal{K}$ and $\vec{v} \in \mathcal{V}$. This space acquires the structure of a \mathcal{G} -module by setting $g(u \otimes \vec{v}) = gu \otimes \vec{v}$ for $u \in \mathcal{U}(\mathcal{G})$, $g \in \mathcal{G}$ and $\vec{v} \in \mathcal{V}$.

Definition: The \mathcal{G} -module $\mathcal{U}(\mathcal{G}) \otimes_{\mathcal{U}(\mathcal{K})} \mathcal{V}$ is called *induced module* from the \mathcal{K} -module \mathcal{V} and denoted by $\text{Ind}_{\mathcal{K}}^{\mathcal{G}} \mathcal{V}$.

Theorem: Let \mathcal{K}' and \mathcal{K}'' be subalgebras of \mathcal{G} such that $\mathcal{K}'' \subset \mathcal{K}' \subset \mathcal{G}$. If \mathcal{V} is a \mathcal{K}'' -module, then

$$\text{Ind}_{\mathcal{K}'}^{\mathcal{G}} (\text{Ind}_{\mathcal{K}''}^{\mathcal{K}'} \mathcal{V}) = \text{Ind}_{\mathcal{K}''}^{\mathcal{G}} \mathcal{V}$$

Theorem: Let \mathcal{G} be a basic Lie superalgebra, \mathcal{K} be a subalgebra of \mathcal{G} such that $\mathcal{G}_0 \subset \mathcal{K}$ and \mathcal{V} a \mathcal{K} -module. If $\{f_1, \dots, f_d\}$ denotes a basis of odd generators of \mathcal{G}/\mathcal{K} , then $\text{Ind}_{\mathcal{K}}^{\mathcal{G}} \mathcal{V} = \bigoplus_{1 \leq i_1 < \dots < i_k \leq d} f_{i_1} \dots f_{i_k} \mathcal{V}$ is a direct sum of subspaces and $\dim \text{Ind}_{\mathcal{K}}^{\mathcal{G}} \mathcal{V} = 2^d \dim \mathcal{V}$.

Example: Consider a basic Lie superalgebra \mathcal{G} of type I (the odd part is the direct sum of two irreducible representations of the even part, that is $\mathcal{G} = sl(m|n)$ or $osp(2|2n)$) with \mathbb{Z} -gradation $\mathcal{G} = \mathcal{G}_{-1} \oplus \mathcal{G}_0 \oplus \mathcal{G}_1$ (\rightarrow Classical Lie superalgebras). Take for \mathcal{K} the subalgebra $\mathcal{G}_0 \oplus \mathcal{G}_1$. Let $\mathcal{V}_0(\Lambda)$ be a \mathcal{G}_0 -module with highest weight Λ , which is extended to a \mathcal{K} -module by setting $\mathcal{G}_1 \mathcal{V}_0(\Lambda) = 0$. Since $\{\mathcal{G}_{-1}, \mathcal{G}_{-1}\} = 0$, only the completely antisymmetric combinations of the generators of \mathcal{G}_{-1} can apply on $\mathcal{V}_0(\Lambda)$. In other words, the \mathcal{G} -module $\mathcal{V}(\Lambda)$ is obtained by

$$\mathcal{V} = \bigwedge(\mathcal{G}_{-1}) \otimes \mathcal{V}_0 \simeq \mathcal{U}(\mathcal{G}_{-1}) \otimes \mathcal{V}_0$$

where

$$\bigwedge(\mathcal{G}_{-1}) = \bigoplus_{k=0}^{\dim \mathcal{G}_{-1}} \wedge^k(\mathcal{G}_{-1})$$

is the exterior algebra over \mathcal{G}_{-1} of dimension 2^d if $d = \dim \mathcal{G}_{-1}$.

It follows that $\mathcal{V}(\Lambda)$ is built from $\mathcal{V}_0(\Lambda)$ by induction of the generators of \mathcal{G}/\mathcal{K} :

$$\mathcal{V} = \mathcal{U}(\mathcal{G}_{-1}) \otimes \mathcal{V}_0 = \mathcal{U}(\mathcal{G}) \otimes_{\mathcal{U}(\mathcal{G}_0 \oplus \mathcal{G}_1)} \mathcal{V}_0 = \text{Ind}_{\mathcal{G}_0 \oplus \mathcal{G}_1}^{\mathcal{G}} \mathcal{V}_0$$

Since $\dim \wedge^k(\mathcal{G}_{-1}) = \binom{d}{k}$, the dimension of \mathcal{V} is given by

$$\dim \mathcal{V}(\Lambda) = \sum_{k=0}^d \binom{d}{k} \dim \mathcal{V}_0(\Lambda) = 2^d \dim \mathcal{V}_0(\Lambda)$$

while its superdimension (\rightarrow Representations: basic definitions) is identically zero

$$\text{sdim } \mathcal{V}(\Lambda) = \sum_{k=0}^d (-1)^k \binom{d}{k} \dim \mathcal{V}_0(\Lambda) = 0$$

Let us stress that such a \mathcal{G} -module is not always an irreducible one.

For more details, see refs. [23, 24, 49].

36 Representations: orthosymplectic superalgebras

A highest weight irreducible representation of $osp(M|N)$ is characterized by its Dynkin labels (\rightarrow Highest weight representations) drawn on the distinguished Dynkin diagram. The different diagrams are the following:

- $osp(2m+1|2n)$ with $\Lambda = (a_1, \dots, a_{m+n})$

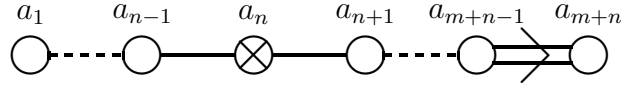

- $osp(2|2n)$ with $\Lambda = (a_1, \dots, a_{n+1})$

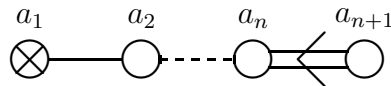

- $osp(2m|2n)$ with $\Lambda = (a_1, \dots, a_{m+n})$

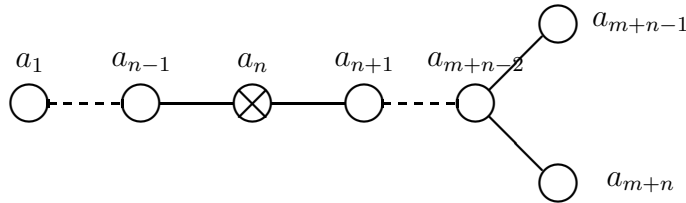

- $osp(1|2n)$ with $\Lambda = (a_1, \dots, a_n)$

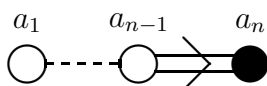

Notice that the superalgebra $osp(2|2n)$ is of type I, while the superalgebras $osp(2m + 1|2n)$ and $osp(2m|2n)$ are of type II: in the first case, the odd part is the direct sum of two irreducible representations of the even part, in the second case it is an irreducible representation of the even part. The numbers a_i are constrained to satisfy the following conditions:

- a_n is integer or half-integer for $osp(2m + 1|2n)$ and $osp(2m|2n)$,
- a_1 is an arbitrary complex number for $osp(2|2n)$.

The coordinates of Λ in the root space characterize a $so(M) \oplus sp(2n)$ representation ($M = 2m$ or $M = 2m + 1$). The $so(M)$ representation can be directly read on the Kac-Dynkin diagram, but the longest simple root of $sp(2n)$ is hidden behind the odd simple roots. From the knowledge of (a_n, \dots, a_{m+n}) , it is possible to deduce the component b that Λ would have with respect to the longest simple root:

- in the $osp(2m + 1|2n)$ case, one has $b = a_n - a_{n+1} - \dots - a_{m+n-1} - \frac{1}{2}a_{m+n}$
- in the $osp(2m|2n)$ case, one has $b = a_n - a_{n+1} - \dots - a_{m+n-2} - \frac{1}{2}(a_{m+n-1} + a_{m+n})$

Notice that the number b has to be a non-negative integer.

The highest weight of a finite representation of $osp(M|2n)$ belongs therefore to a $so(M) \oplus sp(2n)$ representation and thus one must have the following consistency conditions:

- $b \geq 0$
- for $osp(2m + 1|2n)$, $a_{n+b+1} = \dots = a_{n+m} = 0$ if $b \leq m - 1$
- for $osp(2m|2n)$, $a_{n+b+1} = \dots = a_{n+m} = 0$ if $b \leq m - 2$ and $a_{n+m-1} = a_{n+m}$ if $b = m - 1$

We give hereafter the atypicality conditions of the representations for the superalgebras of the orthosymplectic series. If at least one of these conditions is satisfied, the representation is an atypical one. Otherwise, the representation is typical, the dimension of which is given by the number $\dim \mathcal{V}(\Lambda)$.

- superalgebras $osp(2m + 1|2n)$

The atypicality conditions are

$$\begin{aligned} \sum_{k=i}^n a_k - \sum_{k=n+1}^j a_k + 2n - i - j &= 0 \\ \sum_{k=i}^n a_k - \sum_{k=n+1}^j a_k - 2 \sum_{k=j+1}^{m+n-1} a_k - a_{m+n} - 2m - i + j + 1 &= 0 \\ \text{with } 1 \leq i \leq n \leq j \leq m + n - 1 \end{aligned}$$

The dimensions of the typical representations are given by

$$\dim \left(\begin{array}{cccccc} a_1 & & a_{n-1} & a_n & a_{n+1} & a_{n+m-1} & a_{n+m} \\ \circ & \cdots & \circ & \otimes & \circ & \cdots & \circ \Rightarrow \circ \end{array} \right) =$$

$$2^{(2m+1)n} \times \dim \left(\begin{array}{c} a_1 \quad a_{n-1} \quad b - m - \frac{1}{2} \\ \circ \cdots \circ \rightleftarrows \circ \end{array} \right) \times \dim \left(\begin{array}{c} a_1 \quad a_{n+m-1} \quad a_{n+m} \\ \circ \cdots \circ \rightleftarrows \circ \end{array} \right)$$

that is

$$\dim \mathcal{V}(\Lambda) = 2^{(2m+1)n} \prod_{1 \leq i < j \leq n-1} \frac{j-i+1 + \sum_{k=i}^j a_k}{j-i+1} \prod_{n+1 \leq i \leq j \leq m+n-1} \frac{j-i+1 + \sum_{k=i}^j a_k}{j-i+1}$$

$$\prod_{1 \leq i \leq j \leq n} \frac{\sum_{k=i}^{j-1} a_k + 2(\sum_{k=j}^n a_k - \sum_{k=n+1}^{m+n-1} a_k) - a_{m+n} + 2n - 2m - i - j + 1}{2n - i - j + 2}$$

$$\prod_{n+1 \leq i \leq j \leq m+n-1} \frac{\sum_{k=i}^{j-1} a_k + 2 \sum_{k=j}^{m+n-1} a_k + a_{m+n} + 2m - i - j + 1}{2m - i - j + 1}$$

- superalgebras $osp(2|2n)$

The atypicality conditions are

$$a_1 - \sum_{k=2}^i a_k - i + 1 = 0$$

$$a_1 - \sum_{k=2}^i a_k - 2 \sum_{k=i+1}^{n+1} a_k - 2n + i - 1 = 0$$

with $1 \leq i \leq n$

The dimensions of the typical representations are given by

$$\dim \left(\begin{array}{c} a_1 \quad a_2 \quad a_n \quad a_{n+1} \\ \otimes \cdots \circ \rightleftarrows \circ \end{array} \right) = 2^n \times \dim \left(\begin{array}{c} a_2 \quad a_n \quad a_{n+1} \\ \circ \cdots \circ \rightleftarrows \circ \end{array} \right)$$

that is

$$\dim \mathcal{V}(\Lambda) = 2^{2n} \prod_{2 \leq i \leq j \leq n} \frac{a_i + \dots + a_j + j - i + 1}{j - i + 1}$$

$$\prod_{2 \leq i \leq j \leq n+1} \frac{a_i + \dots + a_{j-1} + 2a_j + \dots + 2a_{n+1}}{2n - i - j + 4}$$

- superalgebras $osp(2m|2n)$

The atypicality conditions are

$$\sum_{k=i}^n a_k - \sum_{k=n+1}^j a_k + 2n - i - j = 0$$

with $1 \leq i \leq n \leq j \leq m+n-1$

$$\sum_{k=i}^n a_k - \sum_{k=n+1}^{m+n-2} a_k - a_{m+n} + n - m - i + 1 = 0$$

with $1 \leq i \leq n$

$$\sum_{k=i}^n a_k - \sum_{k=n+1}^j a_k - 2 \sum_{k=j+1}^{m+n-2} a_k - a_{m+n-1} - a_{m+n} - 2m - i + j + 2 = 0$$

with $1 \leq i \leq n \leq j \leq m+n-2$

The dimensions of the typical representations are given by

$$\dim \left(\begin{array}{cccccccc} a_1 & & a_{n-1} & & a_n & & a_{n+1} & & a_{m+n-2} & & a_{n+m-1} \\ \circ & \cdots & \circ & \text{---} & \otimes & \text{---} & \circ & \cdots & \circ & \begin{array}{l} \nearrow \\ \searrow \end{array} & \circ \\ & & & & & & & & & & a_{n+m} \end{array} \right) =$$

$$2^{2mn} \times \dim \left(\begin{array}{ccc} a_1 & & a_{n-1} & & b-m \\ \circ & \cdots & \circ & \text{---} & \circ \\ & & & & \leftarrow \end{array} \right) \times \dim \left(\begin{array}{ccc} a_{n+1} & & a_{n+m-2} & & a_{n+m-1} \\ \circ & \cdots & \circ & \begin{array}{l} \nearrow \\ \searrow \end{array} & \circ \\ & & & & a_{n+m} \end{array} \right)$$

and one obtains the same formula for $\dim \mathcal{V}(\Lambda)$ as for $osp(2m+1|2n)$.

- superalgebras $osp(1|2n)$

The superalgebras $osp(1|2n)$ carry the property of having only typical representation (the Dynkin diagram of $osp(1|2n)$ does not contain any grey dot). One has

$$\dim \mathcal{V}(\Lambda) = \prod_{1 \leq i < j \leq n} \frac{a_i + \dots + a_j + 2(a_{j+1} + \dots + a_{n-1}) + a_n + 2n - i - j}{2n - i - j}$$

$$\prod_{1 \leq i \leq n} \frac{2(a_i + \dots + a_{n-1}) + a_n + 2n - 2i + 1}{2n - 2i + 1}$$

Moreover, the representations of $osp(1|2n)$ can be put in a one-to-one correspondence with those of $so(2n+1)$ [36]. More precisely, one has

$$\dim \left(\begin{array}{ccc} a_1 & & a_{n-1} & & a_n \\ \circ & \cdots & \circ & \text{---} & \bullet \\ & & & & \leftarrow \end{array} \right) = \dim \left(\begin{array}{ccc} a_1 & & a_{n-1} & & a_n \\ \circ & \cdots & \circ & \text{---} & \circ \\ & & & & \leftarrow \end{array} \right)$$

as well as

$$\text{sdim} \left(\begin{array}{ccc} a_1 & & a_{n-1} & & a_n \\ \circ & \cdots & \circ & \text{---} & \bullet \\ & & & & \leftarrow \end{array} \right) = \frac{1}{2^{n-1}} \dim \left(\begin{array}{ccc} a_1 & & a_{n-2} & & a_{n-1} \\ \circ & \cdots & \circ & \begin{array}{l} \nearrow \\ \searrow \end{array} & \circ \\ & & & & a_{n-1} + \\ & & & & a_n + 1 \end{array} \right)$$

(let us recall that $\dim \mathcal{V} = \dim \mathcal{V}_{\bar{0}} + \dim \mathcal{V}_{\bar{1}}$ while $\text{sdim} \mathcal{V} = \dim \mathcal{V}_{\bar{0}} - \dim \mathcal{V}_{\bar{1}}$).

For more details, see refs. [14, 15, 24, 28, 36].

37 Representations: reducibility

Definition: Let \mathcal{G} be a classical Lie superalgebra. A representation $\pi : \mathcal{G} \rightarrow \text{End} \mathcal{V}$ is called *irreducible* if the \mathcal{G} -module \mathcal{V} has no \mathcal{G} -submodules except trivial ones. The \mathcal{G} -module \mathcal{V} is then called a *simple* module. Otherwise the representation π is said *reducible*. In that case, one has $\mathcal{V} = \mathcal{V}' \oplus \mathcal{V}''$, \mathcal{V}'' being a complementary subspace of \mathcal{V}' in \mathcal{V} and the \mathcal{G} -submodule \mathcal{V}' is an invariant subspace under π . If the subspace \mathcal{V}'' is also an invariant

subspace under π , the representation π is said *completely reducible*. The \mathcal{G} -module \mathcal{V} is then called a *semi-simple* module.

Definition: Two representations π and π' of \mathcal{G} being given, with representation spaces \mathcal{V} and \mathcal{V}' , one defines the direct sum $\pi \oplus \pi'$ with representation space $\mathcal{V} \oplus \mathcal{V}'$ and the direct (or tensor) product $\pi \otimes \pi'$ with representation space $\mathcal{V} \otimes \mathcal{V}'$ of the two representations. The action of the representations $\pi \oplus \pi'$ and $\pi \otimes \pi'$ on the corresponding representation spaces is given by, for $X \in \mathcal{G}$, $\vec{v} \in \mathcal{V}$ and $\vec{v}' \in \mathcal{V}'$:

$$\begin{aligned}(\pi \oplus \pi')(X)\vec{v} \oplus \vec{v}' &= \pi(X)\vec{v} \oplus \pi'(X)\vec{v}' \\ (\pi \otimes \pi')(X)\vec{v} \otimes \vec{v}' &= \pi(X)\vec{v} \otimes \vec{v}' + \vec{v} \otimes \pi'(X)\vec{v}'\end{aligned}$$

The representations π and π' of \mathcal{G} being irreducible, the tensor product $\pi \otimes \pi'$ is a representation which is in general reducible. Notice however that, contrary to the Lie algebra case, in the Lie superalgebra case, the tensor product of two irreducible representations is not necessary completely reducible. In fact, one has the following theorem:

Theorem (Djokovic-Hochschild): The only Lie superalgebras for which all finite dimensional representations are completely reducible are the direct products of $osp(1|2n)$ superalgebras and semi-simple Lie algebras.

38 Representations: star and superstar representations

The star and superstar representations of a classical Lie superalgebra are the generalization of the hermitian representations of a simple Lie algebra. The importance of the hermitian representations for simple Lie algebras comes from the fact that the finite dimensional representations of a compact simple Lie algebra are equivalent to hermitian representations.

Let $\mathcal{G} = \mathcal{G}_{\bar{0}} \oplus \mathcal{G}_{\bar{1}}$ be a classical Lie superalgebra. One can define two different adjoint operations as follows.

Definition: An adjoint operation in \mathcal{G} , denoted by \dagger , is a mapping from \mathcal{G} into \mathcal{G} such that:

- i) $X \in \mathcal{G}_i \Rightarrow X^\dagger \in \mathcal{G}_i$ for $i = \bar{0}, \bar{1}$,
- ii) $(\alpha X + \beta Y)^\dagger = \bar{\alpha} X^\dagger + \bar{\beta} Y^\dagger$,
- iii) $\llbracket X, Y \rrbracket^\dagger = \llbracket Y^\dagger, X^\dagger \rrbracket$,
- iv) $(X^\dagger)^\dagger = X$,

where $X, Y \in \mathcal{G}$ and $\alpha, \beta \in \mathbb{C}$.

Definition: A superadjoint operation in \mathcal{G} , denoted by \dagger , is a mapping from \mathcal{G} into \mathcal{G} such that:

- i) $X \in \mathcal{G}_i \Rightarrow X^\dagger \in \mathcal{G}_i$ for $i = \bar{0}, \bar{1}$,
- ii) $(\alpha X + \beta Y)^\dagger = \bar{\alpha} X^\dagger + \bar{\beta} Y^\dagger$,
- iii) $\llbracket X, Y \rrbracket^\dagger = (-1)^{\deg X \cdot \deg Y} \llbracket Y^\dagger, X^\dagger \rrbracket$,
- iv) $(X^\dagger)^\dagger = (-1)^{\deg X} X$,

where $X, Y \in \mathcal{G}$ and $\alpha, \beta \in \mathbb{C}$.

The definitions of the star and superstar representations follow immediately.

Definition: Let \mathcal{G} be a classical Lie superalgebra and π a representation of \mathcal{G} acting in a \mathbb{Z}_2 -graded vector space \mathcal{V} . Then π is a star representation of \mathcal{G} if $\pi(X^\dagger) = \pi(X)^\dagger$ and a superstar representation of \mathcal{G} if $\pi(X^\ddagger) = \pi(X)^\ddagger$ for all $X \in \mathcal{G}$.

The following properties hold:

Property:

1. Any star representation π of \mathcal{G} in a graded Hilbert space \mathcal{V} is completely reducible.
2. Any superstar representation π of \mathcal{G} in a graded Hilbert space \mathcal{V} is completely reducible.
3. The tensor product $\pi \otimes \pi'$ of two star representations (resp. to superstar representations) π and π' is a star representation (resp. a superstar representation).
4. The tensor product $\pi \otimes \pi'$ of two star representations π and π' is completely reducible.

Let us emphasize that the last property does not hold for superstar representations (that is the tensor product of two superstar representations is in general not completely reducible).

The classes of star and superstar representations of the classical Lie superalgebras are the following:

- the superalgebra $A(m, n)$ has two classes of star representations and two classes of superstar representations.
- the superalgebras $B(m, n)$ and $D(m, n)$ have two classes of superstar representations.
- the superalgebra $C(n + 1)$ has either two classes of star representations and two classes of superstar representations, or one class of superstar representations, depending on the definition of the adjoint operation in the Lie algebra part.
- the superalgebras $F(4)$ and $G(3)$ have two classes of superstar representations.
- the superalgebra $P(n)$ has neither star nor superstar representations.
- the superalgebra $Q(n)$ has two classes of star representations.

For more details, see ref. [30].

39 Representations: typicality and atypicality

Any representation of a basic Lie superalgebra $\mathcal{G} = \mathcal{G}_{\bar{0}} \oplus \mathcal{G}_{\bar{1}}$ can be decomposed into a direct sum of irreducible representations of the even subalgebra $\mathcal{G}_{\bar{0}}$. The generators associated to the odd roots will transform a vector basis belonging to a certain representation of $\mathcal{G}_{\bar{0}}$ into a vector in another representation of $\mathcal{G}_{\bar{0}}$ (or into the null vector), while the generators associated to the even roots will operate inside an irreducible representation of $\mathcal{G}_{\bar{0}}$.

The presence of odd roots will have another important consequence in the representation theory of superalgebras. Indeed, one might find in certain representations weight vectors, different from the highest one specifying the representation, annihilated by all the generators corresponding to positive roots. Such vectors have, of course, to be decoupled from the representation. Representations of this kind are called atypical, while the other irreducible representations not suffering this pathology are called typical.

More precisely, let $\mathcal{G} = \mathcal{G}_{\bar{0}} \oplus \mathcal{G}_{\bar{1}}$ be a basic Lie superalgebra with distinguished Cartan subalgebra \mathcal{H} . Let $\Lambda \in \mathcal{H}^*$ be an integral dominant weight. Denote the root system of \mathcal{G} by $\Delta = \Delta_{\bar{0}} \cup \Delta_{\bar{1}}$. One defines $\bar{\Delta}_{\bar{0}}$ as the subset of roots $\alpha \in \Delta_{\bar{0}}$ such that $\alpha/2 \notin \Delta_{\bar{1}}$ and $\bar{\Delta}_{\bar{1}}$ as the subset of roots $\alpha \in \Delta_{\bar{1}}$ such that $2\alpha \notin \Delta_{\bar{0}}$. Let ρ_0 be the half-sum of the roots of $\Delta_{\bar{0}}^+$, $\bar{\rho}_0$ the half-sum of the roots of $\bar{\Delta}_{\bar{0}}^+$, ρ_1 the half-sum of the roots of $\Delta_{\bar{1}}^+$, and $\rho = \rho_0 - \rho_1$.

Definition: The representation π with highest weight Λ is called *typical* if

$$(\Lambda + \rho, \alpha) \neq 0 \quad \text{for all } \alpha \in \bar{\Delta}_{\bar{1}}^+$$

The highest weight Λ is then called typical.

If there exists some $\alpha \in \bar{\Delta}_{\bar{1}}^+$ such that $(\Lambda + \rho, \alpha) = 0$, the representation π and the highest weight Λ are called *atypical*. The number of distinct elements $\alpha \in \bar{\Delta}_{\bar{1}}^+$ for which Λ is atypical is the degree of atypicality of the representation π . If there exists one and only one $\alpha \in \bar{\Delta}_{\bar{1}}^+$ such that $(\Lambda + \rho, \alpha) = 0$, the representation π and the highest weight Λ are called *singly atypical*.

Denoting as before $\bar{\mathcal{V}}(\Lambda)$ the Kac module (\rightarrow Representations: highest weight representations) corresponding to the integral dominant weight Λ , one has the following theorem:

Theorem: The Kac module $\bar{\mathcal{V}}(\Lambda)$ is a simple \mathcal{G} -module if and only if the highest weight Λ is typical.

Properties:

- 1) All the finite dimensional representations of $B(0, n)$ are typical.
- 2) All the finite dimensional representations of $C(n+1)$ are either typical or singly atypical.

Let \mathcal{V} be a typical finite dimensional representation of \mathcal{G} . Then the dimension of $\mathcal{V}(\Lambda)$ is given by

$$\dim \mathcal{V}(\Lambda) = 2^{\dim \Delta_1^+} \prod_{\alpha \in \Delta_0^+} \frac{(\Lambda + \rho, \alpha)}{(\rho_0, \alpha)}$$

and

$$\begin{aligned} \dim \mathcal{V}_0(\Lambda) - \dim \mathcal{V}_1(\Lambda) &= 0 \quad \text{if } \mathcal{G} \neq B(0, n) \\ \dim \mathcal{V}_0(\Lambda) - \dim \mathcal{V}_1(\Lambda) &= \prod_{\alpha \in \bar{\Delta}_0^+} \frac{(\Lambda + \rho, \alpha)}{(\bar{\rho}_0, \alpha)} = \prod_{\alpha \in \bar{\Delta}_0^+} \frac{(\Lambda + \rho, \alpha)}{(\rho, \alpha)} \quad \text{if } \mathcal{G} = B(0, n) \end{aligned}$$

It follows that the fundamental representations of $sl(m|n)$ and $osp(m|n)$ (of dimension $m+n$) and the adjoint representations of the basic Lie superalgebras $\mathcal{G} \neq sl(1|2), osp(1|2n)$ (of dimension $\dim \mathcal{G}$) are *atypical* ones (since $\dim \mathcal{V}_0 - \dim \mathcal{V}_1 \neq 0$).

For more details, see refs. [23, 24].

40 Representations: unitary superalgebras

A highest weight irreducible representation of $sl(m|n)$ is characterized by its Dynkin labels (\rightarrow Highest weight representations) drawn on the distinguished Dynkin diagram. The different diagrams are the following:

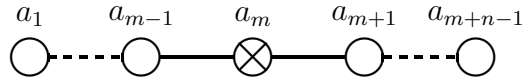

The numbers a_i are constrained:

a_i are non-negative integer for $i = 1, \dots, m-1, m+1, \dots, m+n-1$,

a_m is an arbitrary real number.

For the atypical representations, the numbers a_i have to satisfy one of the following atypicality conditions:

$$\sum_{k=m+1}^j a_k - \sum_{k=1}^{m-1} a_k - a_m - 2m + i - j = 0$$

with $1 \leq i \leq m \leq j \leq m+n-1$.

Otherwise, the representation under consideration is a typical one. Then its dimension is given by

$$\dim \mathcal{V}(\Lambda) = 2^{(m+1)(n+1)} \prod_{1 \leq i \leq j \leq m} \frac{a_i + \dots + a_j + j - i + 1}{j - i + 1} \prod_{m+2 \leq i \leq j \leq m+n+1} \frac{a_i + \dots + a_j + j - i + 1}{j - i + 1}$$

For more details, see refs. [14, 16, 24].

41 Roots, root systems

Let $\mathcal{G} = \mathcal{G}_{\bar{0}} \oplus \mathcal{G}_{\bar{1}}$ be a classical Lie superalgebra of dimension n . Let \mathcal{H} be a Cartan subalgebra of \mathcal{G} . The superalgebra \mathcal{G} can be decomposed as follows:

$$\mathcal{G} = \bigoplus_{\alpha} \mathcal{G}_{\alpha}$$

where

$$\mathcal{G}_{\alpha} = \{x \in \mathcal{G} \mid [h, x] = \alpha(h)x, h \in \mathcal{H}\}$$

The set

$$\Delta = \{\alpha \in \mathcal{H}^* \mid \mathcal{G}_{\alpha} \neq 0\}$$

is by definition the *root system* of \mathcal{G} . A root α is called even (resp. odd) if $\mathcal{G}_{\alpha} \cap \mathcal{G}_{\bar{0}} \neq \emptyset$ (resp. $\mathcal{G}_{\alpha} \cap \mathcal{G}_{\bar{1}} \neq \emptyset$). The set of even roots is denoted by $\Delta_{\bar{0}}$: it is the root system of the even part $\mathcal{G}_{\bar{0}}$ of \mathcal{G} . The set of odd roots is denoted by $\Delta_{\bar{1}}$: it is the weight system of the representation of $\mathcal{G}_{\bar{0}}$ in $\mathcal{G}_{\bar{1}}$. One has $\Delta = \Delta_{\bar{0}} \cup \Delta_{\bar{1}}$. Notice that a root can be both even and odd (however this only occurs in the case of the superalgebra $Q(n)$). The vector space spanned by all the possible roots is called the root space. It is the dual \mathcal{H}^* of the Cartan subalgebra \mathcal{H} as vector space.

Except for $A(1, 1)$, $P(n)$ and $Q(n)$, using the invariant bilinear form defined on the superalgebra \mathcal{G} , one can define a bilinear form on the root space \mathcal{H}^* by $(\alpha_i, \alpha_j) = (H_i, H_j)$ where the H_i form a basis of \mathcal{H} (\rightarrow Cartan matrix, Killing form).

One has the following properties.

Properties:

1. $\mathcal{G}_{(\alpha=0)} = \mathcal{H}$ except for $Q(n)$.
2. $\dim \mathcal{G}_{\alpha} = 1$ when $\alpha \neq 0$ except for $A(1, 1)$, $P(2)$, $P(3)$ and $Q(n)$.
3. Except for $A(1, 1)$, $P(n)$ and $Q(n)$, one has

- $[[\mathcal{G}_\alpha, \mathcal{G}_\beta]] \neq 0$ if and only if $\alpha, \beta, \alpha + \beta \in \Delta$
- $(\mathcal{G}_\alpha, \mathcal{G}_\beta) = 0$ for $\alpha + \beta \neq 0$
- if $\alpha \in \Delta$ (resp. $\Delta_{\bar{0}}, \Delta_{\bar{1}}$), then $-\alpha \in \Delta$ (resp. $\Delta_{\bar{0}}, \Delta_{\bar{1}}$)
- $\alpha \in \Delta \implies 2\alpha \in \Delta$ if and only if $\alpha \in \Delta_{\bar{1}}$ and $(\alpha, \alpha) \neq 0$

The roots of a basic Lie superalgebra do not satisfy many properties of the roots of a simple Lie algebra. In particular, the bilinear form on \mathcal{H}^* has in general pseudo-euclidean signature (except in the case of $B(0, n)$). The roots of a basic Lie superalgebra can be classified into three classes:

- roots α such that $(\alpha, \alpha) \neq 0$ and 2α is not a root. Such roots will be called even or bosonic roots.
- roots α such that $(\alpha, \alpha) \neq 0$ and 2α is still a root (of bosonic type). Such roots will be called odd or fermionic roots of non-zero length.
- roots α such that $(\alpha, \alpha) = 0$. Such roots will be called odd or fermionic roots of zero length (or also isotropic odd roots).

The root systems of the basic Lie superalgebras are given in Table IV.

| superalgebra | even root system $\Delta_{\bar{0}}$ | odd root system $\Delta_{\bar{1}}$ |
|-------------------|---|--|
| $A(m-1, n-1)$ | $\varepsilon_i - \varepsilon_j, \delta_i - \delta_j$ | $\pm(\varepsilon_i - \delta_j)$ |
| $B(m, n)$ | $\pm\varepsilon_i \pm \varepsilon_j, \pm\varepsilon_i, \pm\delta_i \pm \delta_j, \pm 2\delta_i$ | $\pm\varepsilon_i \pm \delta_j, \pm\delta_i$ |
| $B(0, n)$ | $\pm\delta_i \pm \delta_j, \pm 2\delta_i$ | $\pm\delta_i$ |
| $C(n+1)$ | $\pm\delta_i \pm \delta_j, \pm 2\delta_i$ | $\pm\varepsilon \pm \delta_i$ |
| $D(m, n)$ | $\pm\varepsilon_i \pm \varepsilon_j, \pm\delta_i \pm \delta_j, \pm 2\delta_i$ | $\pm\varepsilon_i \pm \delta_j$ |
| $F(4)$ | $\pm\delta, \pm\varepsilon_i \pm \varepsilon_j, \pm\varepsilon_i$ | $\frac{1}{2}(\pm\varepsilon_1 \pm \varepsilon_2 \pm \varepsilon_3 \pm \delta)$ |
| $G(3)$ | $\pm 2\delta, \pm\varepsilon_i, \varepsilon_i - \varepsilon_j$ | $\pm\delta, \pm\varepsilon_i \pm \delta$ |
| $D(2, 1; \alpha)$ | $\pm 2\varepsilon_i$ | $\pm\varepsilon_1 \pm \varepsilon_2 \pm \varepsilon_3$ |

Table IV: Root systems of the basic Lie superalgebras.

For the superalgebras $A(m-1, n-1), B(m, n), D(m, n)$, the indices $i \neq j$ run from 1 to m for the vectors ε and from 1 to n for the vectors δ . For the superalgebras $C(n+1)$, the indices $i \neq j$ run from 1 to n for the vectors δ . For the superalgebras $F(4), G(3), D(2, 1; \alpha)$, the indices $i \neq j$ run from 1 to 3 for the vectors ε , with the condition $\varepsilon_1 + \varepsilon_2 + \varepsilon_3 = 0$ in the case of $G(3)$ (see Tables 4 to 12 for more details).

→ Cartan matrices, Killing form, Simple root systems.

For more details, see refs. [21, 22].

42 Schur's lemma

The Schur's lemma is of special importance. Let us stress however that in the superalgebra case it takes a slightly different form than in the algebra case [22].

Theorem: Let $\mathcal{G} = \mathcal{G}_{\bar{0}} \oplus \mathcal{G}_{\bar{1}}$ be a basic Lie superalgebra and π be an irreducible representation of \mathcal{G} in a complex linear vector space \mathcal{V} . Let

$$\mathcal{C}(\pi) = \left\{ \phi : \mathcal{V} \rightarrow \mathcal{V} \mid \llbracket \pi(X), \phi \rrbracket = 0, \forall X \in \mathcal{G} \right\}$$

where $\phi \in \text{End } \mathcal{V}$. Then either

- $\mathcal{C}(\pi)$ is a multiple of the identity operator \mathbb{I} .
- If $\dim \mathcal{G}_{\bar{0}} = \dim \mathcal{G}_{\bar{1}}$, $\mathcal{C}(\pi) = \{ \mathbb{I}, \sigma \}$ where σ is a non-singular operator in \mathcal{G} permuting $\mathcal{G}_{\bar{0}}$ and $\mathcal{G}_{\bar{1}}$.

43 Serre-Chevalley basis

The Serre presentation of a Lie algebra consists to describe the algebra in terms of simple generators and relations (called the Serre relations), the only parameters being the entries of the Cartan matrix of the algebra. For the basic Lie superalgebras, the presentation is quite similar to the Lie algebra case but with some subtleties.

Let \mathcal{G} be a basic Lie superalgebra of rank r with Cartan subalgebra \mathcal{H} and simple root system Δ^0 and denote by E_i^\pm ($1 \leq i \leq r$) the raising/lowering generators associated to the simple root system Δ^0 . If τ is a subset of $I = \{1, \dots, r\}$, the \mathbb{Z}_2 -gradation is defined by $\deg E_i^\pm = \bar{0}$ if $i \notin \tau$ and $\deg E_i^\pm = \bar{1}$ if $i \in \tau$. The defining commutation relations are

$$\begin{aligned} [H_i, H_j] &= 0 & [H_i, E_j^\pm] &= \pm a_{ij} E_j^\pm \\ [E_i^+, E_j^-] &= \delta_{ij} H_i & \text{for } i &\notin \tau \\ \{E_i^+, E_j^-\} &= \delta_{ij} H_i & \text{for } i &\in \tau \end{aligned}$$

and the Serre relations read as

$$(\text{ad } E_i^\pm)^{1-\tilde{a}_{ij}} E_j^\pm = \sum_{n=0}^{1-\tilde{a}_{ij}} (-1)^n \binom{1-\tilde{a}_{ij}}{n} (E_i^\pm)^{1-\tilde{a}_{ij}-n} E_j^\pm (E_i^\pm)^n = 0$$

where the matrix $\tilde{A} = (\tilde{a}_{ij})$ is deduced from the Cartan matrix $A = (a_{ij})$ of \mathcal{G} by replacing all its positive off-diagonal entries by -1 .

In the case of superalgebras however, the description given by these Serre relations leads in general to a bigger superalgebra than the superalgebra under consideration. It is necessary to write supplementary relations involving more than two generators, in order to

quotient the bigger superalgebra and recover the original one. As one can imagine, these supplementary conditions appear when one deals with odd roots of zero length (that is $a_{ii} = 0$).

The supplementary conditions depend on the different kinds of vertices which appear in the Dynkin diagrams. For the superalgebras $A(m, n)$ with $m, n \geq 1$ and $B(m, n)$, $C(n+1)$, $D(m, n)$, the vertices can be of the following type:

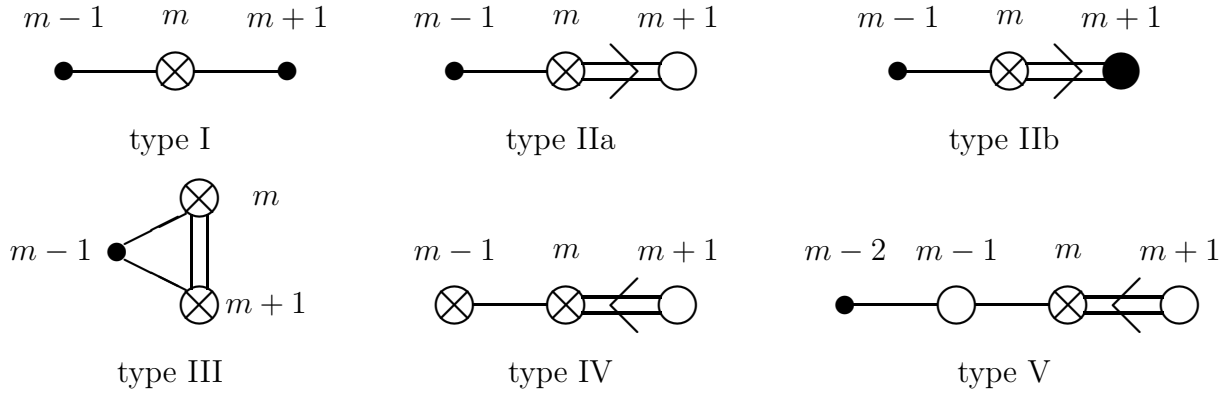

where the small black dots represent either white dots associated to even roots or grey dots associated to isotropic odd roots.

The supplementary conditions take the following form:

- for the type I, IIa and IIb vertices:

$$(\text{ad } E_m^\pm)(\text{ad } E_{m+1}^\pm)(\text{ad } E_m^\pm)E_{m-1}^\pm = (\text{ad } E_m^\pm)(\text{ad } E_{m-1}^\pm)(\text{ad } E_m^\pm)E_{m+1}^\pm = 0$$

- for the type III vertex:

$$(\text{ad } E_m^\pm)(\text{ad } E_{m+1}^\pm)E_{m-1}^\pm - (\text{ad } E_{m+1}^\pm)(\text{ad } E_m^\pm)E_{m-1}^\pm = 0$$

- for the type IV vertex:

$$(\text{ad } E_m^\pm) \left([(\text{ad } E_{m+1}^\pm)(\text{ad } E_m^\pm)E_{m-1}^\pm, (\text{ad } E_m^\pm)E_{m-1}^\pm] \right) = 0$$

- for the type V vertex:

$$(\text{ad } E_m^\pm)(\text{ad } E_{m-1}^\pm)(\text{ad } E_m^\pm)(\text{ad } E_{m+1}^\pm)(\text{ad } E_m^\pm)(\text{ad } E_{m-1}^\pm)E_{m-2}^\pm = 0$$

For $A(m, n)$ with $m = 0$ or $n = 0$, $F(4)$ and $G(3)$, it is not necessary to impose supplementary conditions.

For more details, see refs. [8, 26, 39, 52].

44 Simple root systems

Let $\mathcal{G} = \mathcal{G}_0 \oplus \mathcal{G}_1$ be a *basic* Lie superalgebra with Cartan subalgebra \mathcal{H} and root system $\Delta = \Delta_0 \cup \Delta_1$. Then \mathcal{G} admits a Borel decomposition $\mathcal{G} = \mathcal{N}^+ \oplus \mathcal{H} \oplus \mathcal{N}^-$ where \mathcal{N}^+ and \mathcal{N}^- are subalgebras such that $[\mathcal{H}, \mathcal{N}^+] \subset \mathcal{N}^+$ and $[\mathcal{H}, \mathcal{N}^-] \subset \mathcal{N}^-$ with $\dim \mathcal{N}^+ = \dim \mathcal{N}^-$.

If $\mathcal{G} = \mathcal{H} \oplus_{\alpha} \mathcal{G}_{\alpha}$ is the root decomposition of \mathcal{G} , a root α is called positive if $\mathcal{G}_{\alpha} \cap \mathcal{N}^+ \neq \emptyset$ and negative if $\mathcal{G}_{\alpha} \cap \mathcal{N}^- \neq \emptyset$. A root is called simple if it cannot be decomposed into a sum of positive roots. The set of all simple roots is called a *simple root system* of \mathcal{G} and is denoted here by Δ^0 .

Let ρ_0 be the half-sum of the positive even roots, ρ_1 the half-sum of the positive odd roots and $\rho = \rho_0 - \rho_1$. Then one has for a simple root α_i , $(\rho, \alpha_i) = \frac{1}{2}(\alpha_i, \alpha_i)$. In particular, one has $(\rho, \alpha_i) = 0$ if $\alpha_i \in \Delta_{\overline{1}}^0$ with $(\alpha_i, \alpha_i) = 0$.

We will call $\mathcal{B} = \mathcal{H} \oplus \mathcal{N}^+$ a *Borel subalgebra* of \mathcal{G} . Notice that such a Borel subalgebra is solvable but not maximal solvable. Indeed, adding to such a Borel subalgebra \mathcal{B} a negative simple isotropic root generator (that is a generator associated to an odd root of zero length, \rightarrow Roots), the obtained subalgebra is still solvable since the superalgebra $sl(1,1)$ is solvable. However, \mathcal{B} contains a maximal solvable subalgebra $\mathcal{B}_{\overline{0}}$ of the even part $\mathcal{G}_{\overline{0}}$.

In general, for a basic Lie superalgebra \mathcal{G} , there are many inequivalent classes of conjugacy of Borel subalgebras (while for the simple Lie algebras, all Borel subalgebras are conjugate). To each class of conjugacy of Borel subalgebras of \mathcal{G} is associated a simple root system Δ^0 . Hence, contrary to the Lie algebra case, to a given basic Lie superalgebra \mathcal{G} will be associated in general many inequivalent simple root systems, up to a transformation of the Weyl group $W(\mathcal{G})$ of \mathcal{G} (under a transformation of $W(\mathcal{G})$, a simple root system will be transformed into an equivalent one with the same Dynkin diagram). Let us recall that the Weyl group $W(\mathcal{G})$ of \mathcal{G} is generated by the Weyl reflections ω with respect to the even roots:

$$\omega_{\alpha}(\beta) = \beta - 2 \frac{(\alpha, \beta)}{(\alpha, \alpha)} \alpha$$

where $\alpha \in \Delta_{\overline{0}}$ and $\beta \in \Delta$.

For the basic Lie superalgebras, one can extend the Weyl group $W(\mathcal{G})$ to a larger group by adding the following transformations (called generalized Weyl transformations) associated to the odd roots of \mathcal{G} [10, 25]. For $\alpha \in \Delta_{\overline{1}}$, one defines:

$$\begin{aligned} \omega_{\alpha}(\beta) &= \beta - 2 \frac{(\alpha, \beta)}{(\alpha, \alpha)} \alpha && \text{if } (\alpha, \alpha) \neq 0 \\ \omega_{\alpha}(\beta) &= \beta + \alpha && \text{if } (\alpha, \alpha) = 0 \text{ and } (\alpha, \beta) \neq 0 \\ \omega_{\alpha}(\beta) &= \beta && \text{if } (\alpha, \alpha) = 0 \text{ and } (\alpha, \beta) = 0 \\ \omega_{\alpha}(\alpha) &= -\alpha \end{aligned}$$

Notice that the transformation associated to an odd root α of zero length cannot be lifted to an automorphism of the superalgebra since ω_{α} transforms even roots into odd ones and vice-versa, and the \mathbb{Z}_2 -gradation would not be respected.

The generalization of the Weyl group for a basic Lie superalgebra \mathcal{G} gives a method for constructing all the simple root systems of \mathcal{G} and hence all the inequivalent Dynkin diagrams: a simple root system Δ^0 being given, from any root $\alpha \in \Delta^0$ such that $(\alpha, \alpha) = 0$, one constructs the simple root system $\omega_\alpha(\Delta^0)$ and repeats the procedure on the obtained system until no new basis arises.

In the set of all inequivalent simple root systems of a basic Lie superalgebra, there is one simple root system that plays a particular role: the distinguished simple root system.

Definition: For each basic Lie superalgebra, there exists a simple root system for which the number of odd roots is the smallest one. It is constructed as follows: the even simple roots are given by the simple root system of the even part $\mathcal{G}_\overline{0}$ and the odd simple root is the lowest weight of the representation $\mathcal{G}_\overline{1}$ of $\mathcal{G}_\overline{0}$. Such a simple root system is called the *distinguished simple root system*.

Example:

Consider the basic Lie superalgebra $sl(2|1)$ with Cartan generators H, Z and root generators $E^\pm, F^\pm, \bar{F}^\pm$. The root system is given by $\Delta = \{\pm(\varepsilon_1 - \varepsilon_2), \pm(\varepsilon_1 - \delta), \pm(\varepsilon_2 - \delta)\}$. One can find two inequivalent Borel subalgebras, namely $\mathcal{B}' = \{H, Z, E^+, \bar{F}^+, \bar{F}^-\}$ and $\mathcal{B}'' = \{H, Z, E^+, \bar{F}^+, F^+\}$, with positive root systems $\Delta'^+ = \{\varepsilon_1 - \varepsilon_2, \varepsilon_1 - \delta, \varepsilon_2 - \delta\}$ and $\Delta''^+ = \{\varepsilon_1 - \varepsilon_2, \varepsilon_1 - \delta, -\varepsilon_2 + \delta\}$ respectively. The corresponding simple root systems are $\Delta'^0 = \{\varepsilon_1 - \varepsilon_2, \varepsilon_2 - \delta\}$ (called distinguished simple root system) and $\Delta''^0 = \{\varepsilon_1 - \delta, -\varepsilon_2 + \delta\}$ (called fermionic simple root system). The fermionic simple root system Δ''^0 is obtained from the distinguished one Δ'^0 by the Weyl transformation associated to the odd root $\varepsilon_2 - \delta$: $\omega_{\varepsilon_2 - \delta}(\varepsilon_2 - \delta) = -\varepsilon_2 + \delta$ and $\omega_{\varepsilon_2 - \delta}(\varepsilon_1 - \varepsilon_2) = \varepsilon_1 - \delta$.

We give in Table V the list of the distinguished simple root systems of the basic Lie superalgebras in terms of the orthogonal vectors ε_i and δ_i . For more details, see ref. [21].

| superalgebra \mathcal{G} | distinguished simple root system Δ^0 |
|----------------------------|---|
| $A(m-1, n-1)$ | $\delta_1 - \delta_2, \dots, \delta_{n-1} - \delta_n, \delta_n - \varepsilon_1, \varepsilon_1 - \varepsilon_2, \dots, \varepsilon_{m-1} - \varepsilon_m$ |
| $B(m, n)$ | $\delta_1 - \delta_2, \dots, \delta_{n-1} - \delta_n, \delta_n - \varepsilon_1, \varepsilon_1 - \varepsilon_2, \dots, \varepsilon_{m-1} - \varepsilon_m, \varepsilon_m$ |
| $B(0, n)$ | $\delta_1 - \delta_2, \dots, \delta_{n-1} - \delta_n, \delta_n$ |
| $C(n)$ | $\varepsilon - \delta_1, \delta_1 - \delta_2, \dots, \delta_{n-1} - \delta_n, 2\delta_n$ |
| $D(m, n)$ | $\delta_1 - \delta_2, \dots, \delta_{n-1} - \delta_n, \delta_n - \varepsilon_1, \varepsilon_1 - \varepsilon_2, \dots, \varepsilon_{m-1} - \varepsilon_m, \varepsilon_{m-1} + \varepsilon_m$ |
| $F(4)$ | $\frac{1}{2}(\delta - \varepsilon_1 - \varepsilon_2 - \varepsilon_3), \varepsilon_3, \varepsilon_2 - \varepsilon_3, \varepsilon_1 - \varepsilon_2$ |
| $G(3)$ | $\delta + \varepsilon_3, \varepsilon_1, \varepsilon_2 - \varepsilon_1$ |
| $D(2, 1; \alpha)$ | $\varepsilon_1 - \varepsilon_2 - \varepsilon_3, 2\varepsilon_2, 2\varepsilon_3$ |

Table V: Distinguished simple root systems of the basic Lie superalgebras.

45 Simple and semi-simple Lie superalgebras

Definition: Let $\mathcal{G} = \mathcal{G}_{\bar{0}} \oplus \mathcal{G}_{\bar{1}}$ be a Lie superalgebra.

The Lie superalgebra \mathcal{G} is called *simple* if it does not contain any non-trivial ideal. The Lie superalgebra \mathcal{G} is called *semi-simple* if it does not contain any non-trivial solvable ideal.

A necessary condition for a Lie superalgebra $\mathcal{G} = \mathcal{G}_{\bar{0}} \oplus \mathcal{G}_{\bar{1}}$ to be simple is that the representation of $\mathcal{G}_{\bar{0}}$ on $\mathcal{G}_{\bar{1}}$ is faithful and $\{\mathcal{G}_{\bar{1}}, \mathcal{G}_{\bar{1}}\} = \mathcal{G}_{\bar{0}}$. If the representation of $\mathcal{G}_{\bar{0}}$ on $\mathcal{G}_{\bar{1}}$ is irreducible, then \mathcal{G} is simple.

Recall that if \mathcal{A} is a *semi-simple Lie algebra*, then it can be written as the direct sum of *simple Lie algebras* \mathcal{A}_i : $\mathcal{A} = \oplus_i \mathcal{A}_i$. *It is not the case for superalgebras.* However, the following properties hold.

Properties:

1. If \mathcal{G} is a Lie superalgebra and \mathcal{I} is the maximal solvable ideal, then the quotient \mathcal{G}/\mathcal{I} is a semi-simple Lie superalgebra. However, opposed to the case of Lie algebras, one *cannot* write here $\mathcal{G} = \bar{\mathcal{G}} \ltimes \mathcal{I}$ where $\bar{\mathcal{G}}$ is a direct sum of simple Lie superalgebras.
2. If \mathcal{G} is a Lie superalgebra with a non-singular Killing form, then \mathcal{G} is a direct sum of simple Lie superalgebras with non-singular Killing form.
3. If \mathcal{G} is a Lie superalgebra whose all its finite dimensional representations are completely reducible, then \mathcal{G} is a direct sum of simple Lie algebras and $osp(1|n)$ simple superalgebras.
4. Let $\mathcal{G} = \mathcal{G}_{\bar{0}} \oplus \mathcal{G}_{\bar{1}}$ be a Lie superalgebra such that its even part $\mathcal{G}_{\bar{0}}$ is a semi-simple Lie algebra. Then \mathcal{G} is an elementary extension of a direct sum of Lie algebras or one of the Lie superalgebras $A(n, n)$, $B(m, n)$, $D(m, n)$, $D(2, 1; \alpha)$, $F(4)$, $G(3)$, $P(n)$, $Q(n)$, $\text{Der } Q(n)$ or $G(S_1, \dots, S_r; L)$. (For the definition of $G(S_1, \dots, S_r; L)$, see ref. [21]).

The elementary extension of a Lie superalgebra $\mathcal{G} = \mathcal{G}_{\bar{0}} \oplus \mathcal{G}_{\bar{1}}$ is defined as $\mathcal{G} \ltimes \mathcal{I}$ where \mathcal{I} is an odd commutative ideal and $\{\mathcal{G}_{\bar{1}}, \mathcal{I}\} = 0$.

For more details, see refs. [21, 34].

46 Spinors (in the Lorentz group)

The algebra of the Lorentz group is $o(1, 3)$ whose generators $M_{\mu\nu} = -M_{\nu\mu}$ satisfy the

commutation relations ($\mu, \nu = 0, 1, 2, 3$)

$$[M_{\mu\nu}, M_{\rho\sigma}] = i(-g_{\nu\sigma}M_{\mu\rho} + g_{\nu\rho}M_{\mu\sigma} + g_{\mu\sigma}M_{\nu\rho} - g_{\mu\rho}M_{\nu\sigma})$$

where the metric is $g^{\mu\nu} = 2\delta^{\mu 0}\delta^{\nu 0} - \delta^{\mu\nu} = \text{diag}(1, -1, -1, -1)$ and $g^{\mu\sigma}g_{\sigma\nu} = \delta^\mu_\nu$.

If we define $J_i = \frac{1}{2}\varepsilon_{ijk}M^{jk}$ and $K_i = M^{0i}$, we have

$$\begin{aligned} [J_i, J_j] &= i \varepsilon_{ijk} J_k \\ [K_i, K_j] &= -i \varepsilon_{ijk} J_k \\ [J_i, K_i] &= i \varepsilon_{ijk} K_k \end{aligned}$$

where $i, j, k = 1, 2, 3$ and ε_{ijk} is the completely antisymmetric rank three tensor, $\varepsilon_{123} = 1$.

Defining $M_i = \frac{1}{2}(J_i + iK_i)$ and $N_i = \frac{1}{2}(J_i - iK_i)$, the Lorentz algebra can be rewritten as:

$$\begin{aligned} [M_i, M_j] &= i \varepsilon_{ijk} M_k \\ [N_i, N_j] &= i \varepsilon_{ijk} N_k \\ [M_i, N_j] &= 0 \end{aligned}$$

The finite dimensional irreducible representations of the Lorentz group are labelled by a pair of integers or half-integers (m, n) . These representations are non-unitary since the generators M_i and N_i can be represented by finite dimensional Hermitian matrices while J_i and K_i are not. Because of the relation $J_i = M_i + N_i$, the combination $m + n$ is the spin of the representation. Representations with half-integer spin (resp. integer spin) are called spinorial (resp. tensorial) representations. The two representations $(1/2, 0)$ and $(0, 1/2)$ are the fundamental spinorial representations: all the spinorial and tensorial representations of the Lorentz group can be obtained by tensorialization and symmetrization of these.

The σ^i being the Pauli matrices, one has in the representation $(1/2, 0)$

$$M_i = \frac{1}{2}\sigma^i \quad \text{and} \quad N_i = 0 \quad \text{that is} \quad J_i = \frac{1}{2}\sigma^i \quad \text{and} \quad K_i = -\frac{i}{2}\sigma^i$$

and in the representation $(0, 1/2)$

$$M_i = 0 \quad \text{and} \quad N_i = \frac{1}{2}\sigma^i \quad \text{that is} \quad J_i = \frac{1}{2}\sigma^i \quad \text{and} \quad K_i = \frac{i}{2}\sigma^i$$

The vectors of the representation spaces of the spinorial representations are called (Weyl) *spinors* under the Lorentz group. Define $\sigma^\mu = (\mathbb{I}, \sigma^i)$ and $\bar{\sigma}^\mu = (\mathbb{I}, -\sigma^i)$. Under a Lorentz transformation Λ^μ_ν , a *covariant undotted* spinor ψ_α (resp. *contravariant undotted* spinor ψ^α) transforms as

$$\psi_\alpha \mapsto S_\alpha^\beta \psi_\beta \quad \text{and} \quad \psi^\alpha \mapsto \psi^\beta (S^{-1})^\alpha_\beta$$

where the matrix S is related to the matrix Λ_ν^μ by

$$\Lambda_\nu^\mu = \frac{1}{2} \text{tr}(S\sigma_\nu S^\dagger \bar{\sigma}^\mu)$$

The spinors ψ_α (or ψ^α) transform as the $(1/2, 0)$ representation of the Lorentz group. Under a Lorentz transformation Λ_ν^μ , a *covariant dotted* spinor $\bar{\psi}_{\dot{\alpha}}$ (resp. *contravariant dotted* spinor $\bar{\psi}^{\dot{\alpha}}$) transforms as

$$\bar{\psi}_{\dot{\alpha}} \mapsto \bar{\psi}_{\dot{\beta}} (S^\dagger)^{\dot{\beta}}_{\dot{\alpha}} \quad \text{and} \quad \bar{\psi}^{\dot{\alpha}} \mapsto (S^{\dagger-1})^{\dot{\alpha}}_{\dot{\beta}} \bar{\psi}^{\dot{\beta}}$$

where the matrix S is related to the matrix Λ_ν^μ by

$$\Lambda_\nu^\mu = \frac{1}{2} \text{tr}((S^\dagger)^{-1} \bar{\sigma}_\nu S^{-1} \sigma^\mu)$$

The spinors $\bar{\psi}_{\dot{\alpha}}$ (or $\bar{\psi}^{\dot{\alpha}}$) transform as the $(0, 1/2)$ representation of the Lorentz group. The relation between covariant and contravariant spinors is given by means of the two-dimensional Levi-Civita undotted tensors $\varepsilon_{\alpha\beta}, \varepsilon^{\alpha\beta}$ and dotted tensors $\varepsilon_{\dot{\alpha}\dot{\beta}}, \varepsilon^{\dot{\alpha}\dot{\beta}}$ such that $\varepsilon_{\alpha\beta} = \varepsilon^{\alpha\beta} = -\varepsilon_{\dot{\alpha}\dot{\beta}} = -\varepsilon^{\dot{\alpha}\dot{\beta}}$ and $\varepsilon_{12} = 1$:

$$\psi^\alpha = \varepsilon^{\alpha\beta} \psi_\beta, \quad \psi_\alpha = \psi^\beta \varepsilon_{\beta\alpha}, \quad \bar{\psi}^{\dot{\alpha}} = \bar{\psi}_{\dot{\beta}} \varepsilon^{\dot{\beta}\dot{\alpha}}, \quad \bar{\psi}_{\dot{\alpha}} = \varepsilon_{\dot{\alpha}\dot{\beta}} \bar{\psi}^{\dot{\beta}}$$

Notice that $\bar{\psi}^{\dot{\alpha}} = (\psi^\alpha)^*$ and $\bar{\psi}_{\dot{\alpha}} = (\psi_\alpha)^*$ where the star denotes the complex conjugation, and also $\varepsilon_{\dot{\alpha}\dot{\beta}} = -(\varepsilon_{\alpha\beta})^*$.

Finally, the rule for contracting undotted and dotted spinor indices is the following:

$$\psi\zeta \equiv \psi^\alpha \zeta_\alpha = -\psi_\alpha \zeta^\alpha \quad \text{and} \quad \bar{\psi}\bar{\zeta} \equiv \bar{\psi}_{\dot{\alpha}} \bar{\zeta}^{\dot{\alpha}} = -\bar{\psi}^{\dot{\alpha}} \bar{\zeta}_{\dot{\alpha}}$$

The space inversion leaves the rotation generators J_i invariant but changes the sign of the boost generators K_i . It follows that under the space inversion, the undotted Weyl spinors are transformed into dotted ones and vice-versa. On the (reducible) representation $(1/2, 0) \oplus (0, 1/2)$, the space inversion acts in a well-defined way. The corresponding vectors in the representation space are called *Dirac spinors*. In the Weyl representation, the Dirac spinors are given by

$$\Psi_D = \begin{pmatrix} \psi_\alpha \\ \bar{\chi}^{\dot{\alpha}} \end{pmatrix}$$

Under a Lorentz transformation Λ_ν^μ , a Dirac spinor Ψ_D transforms as

$$\Psi_D \mapsto L \Psi_D = \begin{pmatrix} S(\Lambda_\nu^\mu) & 0 \\ 0 & S(\Lambda_\nu^{\mu\dagger})^{-1} \end{pmatrix} \begin{pmatrix} \psi_\alpha \\ \bar{\chi}^{\dot{\alpha}} \end{pmatrix} = \begin{pmatrix} S(\Lambda_\nu^\mu) \psi_\alpha \\ S(\Lambda_\nu^{\mu\dagger})^{-1} \bar{\chi}^{\dot{\alpha}} \end{pmatrix}$$

The generators of the Lorentz group in the $(1/2, 0) \oplus (0, 1/2)$ representation are given by $\Sigma^{\mu\nu} = \frac{i}{2} [\gamma^\mu, \gamma^\nu]$ where the matrices γ^μ are called the *Dirac matrices*. They satisfy the Clifford algebra in four dimensions:

$$\{\gamma^\mu, \gamma^\nu\} = 2g^{\mu\nu}$$

One defines also the γ_5 matrix by $\gamma_5 = i\gamma^0\gamma^1\gamma^2\gamma^3$ such that $\{\gamma_5, \gamma^\mu\} = 0$ and $\gamma_5^2 = \mathbb{I}$.

The adjoint spinor $\bar{\Psi}$ and the charge conjugated spinors Ψ^c and $\bar{\Psi}^c$ of a Dirac spinor $\Psi = \begin{pmatrix} \psi_\alpha \\ \bar{\chi}^{\dot{\alpha}} \end{pmatrix}$ are defined by $\bar{\Psi} = (\chi^\alpha \bar{\psi}_{\dot{\alpha}})$, $\Psi^c = \begin{pmatrix} \chi_\alpha \\ \bar{\psi}^{\dot{\alpha}} \end{pmatrix}$ and $\bar{\Psi}^c = (\psi^\alpha \bar{\chi}_{\dot{\alpha}})$. The spinors Ψ and Ψ^c are related through the charge conjugation matrix C by $\Psi^c = C\bar{\Psi}^t$. Moreover, one has $C^{-1}\gamma^\mu C = -(\gamma^\mu)^t$. The six matrices $C, \gamma^\mu\gamma_5 C, \gamma_5 C$ are antisymmetric and the ten matrices $\gamma^\mu C, \Sigma^{\mu\nu} C$ are symmetric. They form a set of 16 linearly independent matrices.

A Majorana spinor is a Dirac spinor such that $\Psi = \Psi^c$. For such a spinor, there is a relation between the two Weyl components: a Majorana spinor Ψ has the form $\Psi = \begin{pmatrix} \psi_\alpha \\ \bar{\psi}^{\dot{\alpha}} \end{pmatrix}$. In the Majorana representation of the γ matrices, the components of a Majorana spinor are all real and the γ matrices are all purely imaginary.

The γ matrices are given, in the Weyl representation, by

$$\gamma^0 = \begin{pmatrix} 0 & \sigma^0 \\ \sigma^0 & 0 \end{pmatrix} \quad \gamma^i = \begin{pmatrix} 0 & \sigma^i \\ -\sigma^i & 0 \end{pmatrix} \quad \gamma_5 = \begin{pmatrix} \mathbb{I} & 0 \\ 0 & -\mathbb{I} \end{pmatrix} \quad C = \begin{pmatrix} -i\sigma^2 & 0 \\ 0 & i\sigma^2 \end{pmatrix}$$

Another often used representation of the γ matrices is the Dirac representation:

$$\gamma_0 = \begin{pmatrix} \sigma_0 & 0 \\ 0 & -\sigma_0 \end{pmatrix} \quad \gamma^i = \begin{pmatrix} 0 & \sigma^i \\ -\sigma^i & 0 \end{pmatrix} \quad \gamma_5 = \begin{pmatrix} 0 & \mathbb{I} \\ \mathbb{I} & 0 \end{pmatrix} \quad C = \begin{pmatrix} 0 & -i\sigma^2 \\ -i\sigma^2 & 0 \end{pmatrix}$$

Finally, in the Majorana representation, one has:

$$\gamma^1 = \begin{pmatrix} i\sigma^3 & 0 \\ 0 & i\sigma^3 \end{pmatrix} \quad \gamma^2 = \begin{pmatrix} 0 & -\sigma^2 \\ \sigma^2 & 0 \end{pmatrix} \quad \gamma^3 = \begin{pmatrix} -i\sigma^1 & 0 \\ 0 & -i\sigma^1 \end{pmatrix}$$

$$\gamma^0 = \begin{pmatrix} 0 & \sigma^2 \\ \sigma^2 & 0 \end{pmatrix} \quad \gamma_5 = \begin{pmatrix} \sigma^2 & 0 \\ 0 & -\sigma^2 \end{pmatrix} \quad C = \begin{pmatrix} 0 & -i\sigma^2 \\ -i\sigma^2 & 0 \end{pmatrix}$$

47 Strange superalgebras $P(n)$

We consider the superalgebra $A(n-1, n-1)$ and $P(n-1)$ the subalgebra of $A(n-1, n-1)$ generated by the $2n \times 2n$ matrices of the form

$$\begin{pmatrix} \lambda & S \\ A & -\lambda^t \end{pmatrix}$$

where λ are $sl(n)$ matrices, S and A are $n \times n$ symmetric and antisymmetric complex matrices which can be seen as elements of the twofold symmetric representation ([2] in Young tableau notation) of dimension $n(n+1)/2$ and of the $(n-2)$ -fold antisymmetric representation ($[1^{n-2}]$ in Young tableau notation) of dimension $n(n-1)/2$ respectively.

The \mathbb{Z} -gradation of the superalgebra $P(n-1)$ being $\mathcal{G} = \mathcal{G}_{-1} \oplus \mathcal{G}_0 \oplus \mathcal{G}_1$ where $\mathcal{G}_0 = sl(n)$, $\mathcal{G}_1 = [2]$ and $\mathcal{G}_{-1} = [1^{n-2}]$, the subspaces \mathcal{G}_i satisfy the following commutation relations

$$\begin{aligned} [\mathcal{G}_0, \mathcal{G}_0] &\subset \mathcal{G}_0 & [\mathcal{G}_0, \mathcal{G}_{\pm 1}] &\subset \mathcal{G}_{\pm 1} \\ \{\mathcal{G}_1, \mathcal{G}_1\} &= \{\mathcal{G}_{-1}, \mathcal{G}_{-1}\} = 0 & \{\mathcal{G}_1, \mathcal{G}_{-1}\} &\subset \mathcal{G}_0 \end{aligned}$$

The \mathbb{Z} -gradation is consistent: $\mathcal{G}_{\bar{0}} = \mathcal{G}_0$ and $\mathcal{G}_{\bar{1}} = \mathcal{G}_{-1} \oplus \mathcal{G}_1$.

Defining the Cartan subalgebra \mathcal{H} as the Cartan subalgebra of the even part, the root system $\Delta = \Delta_{\bar{0}} \cup \Delta_{\bar{1}}$ of $P(n-1)$ can be expressed in terms of the orthogonal vectors $\varepsilon_1, \dots, \varepsilon_n$ as

$$\Delta_{\bar{0}} = \left\{ \alpha_{ij} = \varepsilon_i - \varepsilon_j \right\}$$

and

$$\Delta_{\bar{1}} = \left\{ \pm \beta_{ij} = \pm \left(\varepsilon_i + \varepsilon_j - \frac{2}{n} \sum_{k=1}^n \varepsilon_k \right), \gamma_i = 2\varepsilon_i - \frac{2}{n} \sum_{k=1}^n \varepsilon_k \right\}$$

Denoting by H_i the Cartan generators, by E_α the even root generators and by E_β, E_γ the odd root generators of $P(n-1)$, the commutation relations in the Cartan-Weyl basis are the following:

$$\begin{aligned} [H_k, E_{\alpha_{ij}}] &= (\delta_{ik} - \delta_{jk} - \delta_{i,k+1} + \delta_{j,k+1}) E_{\alpha_{ij}} \\ [H_k, E_{\beta_{ij}}] &= (\delta_{ik} + \delta_{jk} - \delta_{i,k+1} - \delta_{j,k+1}) E_{\beta_{ij}} \\ [H_k, E_{-\beta_{ij}}] &= -(\delta_{ik} + \delta_{jk} - \delta_{i,k+1} - \delta_{j,k+1}) E_{-\beta_{ij}} \\ [H_k, E_{\gamma_i}] &= 2(\delta_{ik} - \delta_{i,k+1}) E_{\gamma_i} \\ [E_{\alpha_{ij}}, E_{\alpha_{kl}}] &= \delta_{jk} E_{\alpha_{il}} - \delta_{il} E_{\alpha_{kj}} \\ [E_{\alpha_{ij}}, E_{-\alpha_{ij}}] &= \sum_{k=i}^{j-1} H_k \\ [E_{\alpha_{ij}}, E_{\beta_{kl}}] &= \begin{cases} \delta_{jk} E_{\beta_{il}} + \delta_{jl} E_{\beta_{ik}} & \text{if } (i, j) \neq (k, l) \\ E_{\gamma_i} & \text{if } (i, j) = (k, l) \end{cases} \\ [E_{\alpha_{ij}}, E_{-\beta_{kl}}] &= \begin{cases} -\delta_{ik} E_{-\beta_{jl}} + \delta_{il} E_{-\beta_{jk}} & \text{if } (i, j) \neq (k, l) \\ 0 & \text{if } (i, j) = (k, l) \end{cases} \\ [E_{\alpha_{ij}}, E_{\gamma_k}] &= \delta_{jk} E_{\beta_{ik}} \\ \{E_{-\beta_{ij}}, E_{\gamma_k}\} &= -\delta_{ik} E_{\alpha_{kj}} + \delta_{jk} E_{\alpha_{ki}} \\ \{E_{\beta_{ij}}, E_{-\beta_{kl}}\} &= \begin{cases} -\delta_{ik} E_{\alpha_{jl}} + \delta_{il} E_{\alpha_{jk}} - \delta_{jk} E_{\alpha_{il}} + \delta_{jl} E_{\alpha_{ik}} & \text{if } (i, j) \neq (k, l) \\ \sum_{k=i}^{j-1} H_k & \text{if } (i, j) = (k, l) \end{cases} \\ \{E_{\beta_{ij}}, E_{\beta_{kl}}\} &= \{E_{-\beta_{ij}}, E_{-\beta_{kl}}\} = \{E_{\beta_{ij}}, E_{\gamma_k}\} = 0 \end{aligned}$$

Let us emphasize that $P(n)$ is a *non-contragredient* simple Lie superalgebra, that is the number of positive roots and the number of negative roots are not equal. Moreover, since every bilinear form is identically vanishing in $P(n)$, it is impossible to define a non-degenerate scalar product on the root space. It follows that the notions of Cartan matrix and Dynkin diagram are not defined for $P(n)$. However, using an extension of $P(n)$ by suitable diagonal matrices, one can construct a non-vanishing bilinear form on the Cartan subalgebra of this extension and therefore generalize in this case the notions of Cartan matrix and Dynkin diagram.

→ Oscillator realization of the strange superalgebras.

For more details, see ref. [11].

48 Strange superalgebras $Q(n)$

We consider the superalgebra $sl(n|n)$ and $\tilde{Q}(n-1)$ the subalgebra of $sl(n|n)$ generated by the $2n \times 2n$ matrices of the form

$$\begin{pmatrix} A & B \\ B & A \end{pmatrix}$$

where A and B are $sl(n)$ matrices. The even part of the superalgebra $\tilde{Q}(n-1)$ is the Lie algebra $\mathcal{G}_{\bar{0}} = sl(n) \oplus U(1)$ of dimension n^2 and the odd part is the adjoint representation $\mathcal{G}_{\bar{1}}$ of $sl(n)$ of dimension $n^2 - 1$. The even generators of $\mathcal{G}_{\bar{0}}$ are divided into the $sl(n)$ Cartan generators H_i with $1 \leq i \leq n-1$, the $U(1)$ generator Z and the $n(n-1)$ root generators E_{ij} with $1 \leq i \neq j \leq n$ of $sl(n)$. The odd root generators of $\mathcal{G}_{\bar{1}}$ are also divided into two parts, F_{ij} with $1 \leq i \neq j \leq n$ and K_i with $1 \leq i \leq n-1$. This superalgebra $\tilde{Q}(n-1)$ is not a simple superalgebra: in order to obtain a simple superalgebra, one should factor out the one-dimensional center, as in the case of the $sl(n|n)$ superalgebra. We will denote by $Q(n-1)$ the simple superalgebra $\tilde{Q}(n-1)/U(1)$.

Following the definition of the Cartan subalgebra (\rightarrow), the strange superalgebra $Q(n-1)$ has the property that the Cartan subalgebra \mathcal{H} does not coincide with the Cartan subalgebra of the even part $sl(n)$, but admits also an odd part: $\mathcal{H} \cap \mathcal{G}_{\bar{1}} \neq \emptyset$. More precisely, one has

$$\mathcal{H} = \mathcal{H}_{\bar{0}} \oplus \mathcal{H}_{\bar{1}}$$

where $\mathcal{H}_{\bar{0}}$ is spanned by the H_i generators and $\mathcal{H}_{\bar{1}}$ by the K_i generators ($1 \leq i \leq n-1$). However, since the K_i generators are odd, the root generators E_{ij} and F_{ij} are not eigenvectors of $\mathcal{H}_{\bar{1}}$. It is convenient in this case to give the root decomposition with respect to $\mathcal{H}_{\bar{0}} = \mathcal{H} \cap \mathcal{G}_{\bar{0}}$ instead of \mathcal{H} . The root system Δ of $Q(n-1)$ coincide then with

the root system of $sl(n)$. One has

$$\mathcal{G} = \mathcal{G}_{\bar{0}} \oplus \mathcal{G}_{\bar{1}} = \mathcal{H}_{\bar{0}} \oplus \left(\bigoplus_{\alpha \in \Delta} \mathcal{G}_{\alpha} \right) \quad \text{with} \quad \dim \mathcal{G}_{(\alpha \neq 0)} = 2 \text{ and } \dim \mathcal{G}_{(\alpha=0)} = n$$

Moreover, since $\dim \mathcal{G}_{\alpha} \cap \mathcal{G}_{\bar{0}} \neq \emptyset$ and $\dim \mathcal{G}_{\alpha} \cap \mathcal{G}_{\bar{1}} \neq \emptyset$ for any non-zero root α , the non-zero roots of $Q(n-1)$ are both even and odd.

Denoting by H_i the Cartan generators, by E_{ij} the even root generators and by F_{ij} the odd root generators of $\tilde{Q}(n)$, the commutation relations in the Cartan-Weyl basis are the following:

$$\begin{aligned} [H_i, H_j] &= [H_i, K_j] = 0 \\ \{K_i, K_j\} &= \frac{2}{n}(2\delta_{ij} - \delta_{i,j+1} - \delta_{i,j-1}) \left(Z - \sum_{k=1}^{n-1} kH_k \right) \\ &\quad + 2(\delta_{ij} - \delta_{i,j+1}) \sum_{k=i}^{n-1} H_k + 2(\delta_{ij} - \delta_{i,j-1}) \sum_{k=i+1}^{n-1} H_k \\ [H_k, E_{ij}] &= (\delta_{ik} - \delta_{jk} - \delta_{i,k+1} + \delta_{j,k+1})E_{ij} \\ [H_k, F_{ij}] &= (\delta_{ik} - \delta_{jk} - \delta_{i,k+1} + \delta_{j,k+1})F_{ij} \\ [K_k, E_{ij}] &= (\delta_{ik} - \delta_{jk} - \delta_{i,k+1} + \delta_{j,k+1})F_{ij} \\ \{K_k, F_{ij}\} &= (\delta_{ik} + \delta_{jk} - \delta_{i,k+1} - \delta_{j,k+1})E_{ij} \\ [E_{ij}, E_{kl}] &= \delta_{jk}E_{il} - \delta_{il}E_{kj} \quad (i, j) \neq (k, l) \\ [E_{ij}, E_{ji}] &= \sum_{k=i}^{j-1} H_k \\ [E_{ij}, F_{kl}] &= \delta_{jk}F_{il} - \delta_{il}F_{kj} \quad (i, j) \neq (k, l) \\ [E_{ij}, F_{ji}] &= \sum_{k=i}^{j-1} K_k \\ \{F_{ij}, F_{kl}\} &= \delta_{jk}E_{il} + \delta_{il}E_{kj} \quad (i, j) \neq (k, l) \\ \{F_{ij}, F_{ji}\} &= \frac{2}{n}Z + \frac{n-2}{n} \left(2 \sum_{k=i}^{n-1} kH_k - n \sum_{k=i}^{n-1} H_k - n \sum_{k=j}^{n-1} H_k \right) \end{aligned}$$

→ Cartan subalgebras, Oscillator realization of the strange superalgebras.

49 Subsuperalgebras (regular)

Definition: Let \mathcal{G} be a basic Lie superalgebra and consider its canonical root decomposition

$$\mathcal{G} = \mathcal{H} \oplus \bigoplus_{\alpha \in \Delta} \mathcal{G}_{\alpha}$$

where \mathcal{H} is a Cartan subalgebra of \mathcal{G} and Δ its corresponding root system (\rightarrow).

A subsuperalgebra \mathcal{G}' of \mathcal{G} is called *regular* (by analogy with the algebra case) if it has the root decomposition

$$\mathcal{G}' = \mathcal{H}' \oplus \bigoplus_{\alpha' \in \Delta'} \mathcal{G}'_{\alpha'}$$

where $\mathcal{H}' \subset \mathcal{H}$ and $\Delta \subset \Delta'$. The semi-simplicity of \mathcal{G}' will be insured if to each $\alpha' \in \Delta'$ then $-\alpha' \in \Delta'$ and \mathcal{H}' is the linear closure of Δ' .

The method for finding the regular semi-simple sub(super)algebras of a given basic Lie superalgebra \mathcal{G} is completely analogous to the usual one for Lie algebras by means of extended Dynkin diagrams. However, one has now to consider all the Dynkin diagrams associated to the inequivalent simple root systems. For a given simple root system Δ^0 of \mathcal{G} , one considers the associated Dynkin diagram. The corresponding extended simple root system is $\widehat{\Delta}^0 = \Delta^0 \cup \{\Psi\}$ where Ψ is the lowest root with respect to Δ^0 , to which is associated the extended Dynkin diagram. Now, deleting arbitrarily some dot(s) of the extended diagram, will yield to some connected Dynkin diagram or a set of disjointed Dynkin diagrams corresponding to a regular semi-simple sub(super)algebra of \mathcal{G} . Indeed, taking away one or more roots from $\widehat{\Delta}^0$, one is left with a set of independent roots which constitute the simple root system of a regular semi-simple subsuperalgebra of \mathcal{G} . Then repeating the same operation on the obtained Dynkin diagrams – that is adjunction of a dot associated to the lowest root of a simple part and cancellation of one arbitrary dot (or two in the unitary case) – as many time as necessary, one obtains all the Dynkin diagrams associated with regular semi-simple basic Lie sub(super)algebras. In order to get the maximal regular semi-simple sub(super)algebras of the same rank r of \mathcal{G} , only the first step has to be achieved. The other possible maximal regular subsuperalgebras of \mathcal{G} if they exist will be obtained by deleting only one dot in the non-extended Dynkin diagram of \mathcal{G} and will be therefore of rank $r - 1$.

The table VI presents the list of the maximal regular semi-simple sub(super)algebras for the basic Lie superalgebras.

\rightarrow Cartan subalgebras, Dynkin diagrams, Roots, Simple and semi-simple Lie superalgebras.

For more details, see ref. [48].

50 Subsuperalgebras (singular)

Definition: Let \mathcal{G} be a basic Lie superalgebra and \mathcal{G}' a subsuperalgebra of \mathcal{G} . \mathcal{G}' is called a *singular* subsuperalgebra of \mathcal{G}' if it is not regular (\rightarrow).

| superalg. | subsuperalgebra | superalg. | subsuperalgebra |
|-------------------|---|------------|--|
| $A(m, n)$ | $A(i, j) \oplus A(m - i - 1, n - j - 1)$ $A_m \oplus A_n$ | $C(n + 1)$ | $C_i \oplus C(n - i + 1)$ C_n |
| $B(m, n)$ | $B(i, j) \oplus D(m - i, n - j)$ $B_m \oplus C_n$ $D(m, n)$ | $D(m, n)$ | $D(i, j) \oplus D(m - i, n - j)$ $D_m \oplus C_n$ $A(m - 1, n - 1)$ |
| $G(3)$ | $A_1 \oplus G_2$ $A_1 \oplus B(1, 1)$ $A_2 \oplus B(0, 1)$ $A(0, 2)$ $D(2, 1; 3)$ $G(3)$ | $F(4)$ | $A_1 \oplus B_3$ $A_2 \oplus A(0, 1)$ $A_1 \oplus D(2, 1; 2)$ $A(0, 3)$ $C(3)$ $F(4)$ |
| $D(2, 1; \alpha)$ | $A_1 \oplus A_1 \oplus A_1$ $A(0, 1)$ $D(2, 1; \alpha)$ | | |

Table VI: Maximal regular sub(super)algebras of the basic Lie superalgebras.

Some of the singular subsuperalgebras of the basic Lie superalgebras can be found by the folding technique. Let \mathcal{G} be a basic Lie superalgebra, with non-trivial outer automorphism ($\text{Out}(\mathcal{G})$ does not reduce to the identity). Then, there exists at least one Dynkin diagram of \mathcal{G} which has the symmetry given by $\text{Out}(\mathcal{G})$. One can notice that each symmetry τ described on that Dynkin diagram induces a direct construction of the subsuperalgebra \mathcal{G}' invariant under the \mathcal{G} outer automorphisms associated to τ . Indeed, if the simple root α is transformed into $\tau(\alpha)$, then $\frac{1}{2}(\alpha + \tau(\alpha))$ is τ -invariant since $\tau^2 = 1$, and appears as a simple root of \mathcal{G}' associated to the generators $E_\alpha + E_{\tau(\alpha)}$, the generator E_α (resp. $E_{\tau(\alpha)}$) corresponding to the root α (resp. $\tau(\alpha)$). A Dynkin diagram of \mathcal{G}' will therefore be obtained by folding the \mathbb{Z}_2 -symmetric Dynkin diagram of \mathcal{G} , that is by transforming each couple $(\alpha, \tau(\alpha))$ into the root $\frac{1}{2}(\alpha + \tau(\alpha))$ of \mathcal{G}' . One obtains the following invariant subsuperalgebras (which are singular):

| superalgebra \mathcal{G} | singular subsuperalgebra \mathcal{G}' |
|----------------------------|---|
| $sl(2m + 1 2n)$ | $osp(2m + 1 2n)$ |
| $sl(2m 2n)$ | $osp(2m 2n)$ |
| $osp(2m 2n)$ | $osp(2m - 1 2n)$ |
| $osp(2 2n)$ | $osp(1 2n)$ |

51 Superalgebra, subsuperalgebra

Definition: Let \mathcal{A} be an algebra over a field \mathbb{K} of characteristic zero (usually $\mathbb{K} = \mathbb{R}$ or \mathbb{C}) with internal laws $+$ and \cdot . One sets $\mathbb{Z}_2 = \mathbb{Z}/2\mathbb{Z} = \{\bar{0}, \bar{1}\}$. \mathcal{A} is called a superalgebra or \mathbb{Z}_2 -graded algebra if \mathcal{A} can be written into a direct sum of two spaces $\mathcal{A} = \mathcal{A}_{\bar{0}} \oplus \mathcal{A}_{\bar{1}}$, such that

$$\mathcal{A}_{\bar{0}} \cdot \mathcal{A}_{\bar{0}} \subset \mathcal{A}_{\bar{0}}, \quad \mathcal{A}_{\bar{0}} \cdot \mathcal{A}_{\bar{1}} \subset \mathcal{A}_{\bar{1}}, \quad \mathcal{A}_{\bar{1}} \cdot \mathcal{A}_{\bar{1}} \subset \mathcal{A}_{\bar{0}}$$

Elements $X \in \mathcal{A}_{\bar{0}}$ are called even or of degree $\deg X = 0$ while elements $X \in \mathcal{A}_{\bar{1}}$ are called odd or of degree $\deg X = 1$.

One defines the *Lie superbracket* or *supercommutator* of two elements X and Y by

$$\llbracket X, Y \rrbracket = X \cdot Y - (-1)^{\deg X \cdot \deg Y} Y \cdot X$$

A superalgebra \mathcal{A} is called associative if $(X \cdot Y) \cdot Z = X \cdot (Y \cdot Z)$ for all elements $X, Y, Z \in \mathcal{A}$. A superalgebra \mathcal{A} is called commutative if $X \cdot Y = Y \cdot X$ for all elements $X, Y \in \mathcal{A}$.

Definition: A (graded) subalgebra $\mathcal{K} = \mathcal{K}_{\bar{0}} \oplus \mathcal{K}_{\bar{1}}$ of a superalgebra $\mathcal{A} = \mathcal{A}_{\bar{0}} \oplus \mathcal{A}_{\bar{1}}$ is a non-empty set $\mathcal{K} \subset \mathcal{A}$ which is a superalgebra with the two composition laws induced by \mathcal{A} such that $\mathcal{K}_{\bar{0}} \subset \mathcal{A}_{\bar{0}}$ and $\mathcal{K}_{\bar{1}} \subset \mathcal{A}_{\bar{1}}$.

Definition: A homomorphism Φ from a superalgebra \mathcal{A} into a superalgebra \mathcal{A}' is a linear application from \mathcal{A} into \mathcal{A}' which respects the \mathbb{Z}_2 -gradation, that is $\Phi(\mathcal{A}_{\bar{0}}) \subset \mathcal{A}'_{\bar{0}}$ and $\Phi(\mathcal{A}_{\bar{1}}) \subset \mathcal{A}'_{\bar{1}}$.

Let \mathcal{A} and \mathcal{A}' be two superalgebras. One defines the tensor product $\mathcal{A} \otimes \mathcal{A}'$ of the two superalgebras by

$$(X_1 \otimes X'_1)(X_2 \otimes X'_2) = (-1)^{\deg X_2 \cdot \deg X'_1} (X_1 X_2 \otimes X'_1 X'_2)$$

if $X_1, X_2 \in \mathcal{A}$ and $X'_1, X'_2 \in \mathcal{A}'$.

→ Lie Superalgebras.

52 Superalgebra $osp(1|2)$

The superalgebra $osp(1|2)$ is the simplest one and can be viewed as the supersymmetric version of $sl(2)$. It contains three bosonic generators E^+, E^-, H which form the Lie algebra $sl(2)$ and two fermionic generators F^+, F^- , whose non-vanishing commutation relations

in the Cartan-Weyl basis read as

$$\begin{aligned}
[H, E^\pm] &= \pm E^\pm & [E^+, E^-] &= 2H \\
[H, F^\pm] &= \pm \frac{1}{2} F^\pm & \{F^+, F^-\} &= \frac{1}{2} H \\
[E^\pm, F^\mp] &= -F^\pm & \{F^\pm, F^\pm\} &= \pm \frac{1}{2} E^\pm
\end{aligned}$$

The three-dimensional matrix representation (fundamental representation) is given by

$$\begin{aligned}
H &= \begin{pmatrix} \frac{1}{2} & 0 & 0 \\ 0 & -\frac{1}{2} & 0 \\ 0 & 0 & 0 \end{pmatrix} & E^+ &= \begin{pmatrix} 0 & 1 & 0 \\ 0 & 0 & 0 \\ 0 & 0 & 0 \end{pmatrix} & E^- &= \begin{pmatrix} 0 & 0 & 0 \\ 1 & 0 & 0 \\ 0 & 0 & 0 \end{pmatrix} \\
F^+ &= \begin{pmatrix} 0 & 0 & \frac{1}{2} \\ 0 & 0 & 0 \\ 0 & \frac{1}{2} & 0 \end{pmatrix} & F^- &= \begin{pmatrix} 0 & 0 & 0 \\ 0 & 0 & -\frac{1}{2} \\ \frac{1}{2} & 0 & 0 \end{pmatrix}
\end{aligned}$$

The quadratic Casimir operator is

$$C_2 = H^2 + \frac{1}{2}(E^+E^- + E^-E^+) - (F^+F^- - F^-F^+)$$

The superalgebra $osp(1|2)$ reveals many features which make it very close to the Lie algebras. In particular, one has the following results for the representation theory:

1. All finite dimensional representations of $osp(1|2)$ are completely reducible.
2. Any irreducible representation of $osp(1|2)$ is typical.
3. An irreducible representation \mathcal{R} of $osp(1|2)$ is characterized by a non-negative integer or half-integer $j = 0, 1/2, 1, 3/2, \dots$ and decomposes under the even part $sl(2)$ into two multiplets $\mathcal{R}_j = D_j \oplus D_{j-1/2}$ for $j \neq 0$, the case $j = 0$ reducing to the trivial one-dimensional representation. The dimension of an irreducible representation \mathcal{R}_j of $osp(1|2)$ is $4j + 1$. The eigenvalue of the quadratic Casimir C_2 in the representation \mathcal{R}_j is $j(j + \frac{1}{2})$.
4. The product of two irreducible $osp(1|2)$ representations decomposes as follows:

$$\mathcal{R}_{j_1} \otimes \mathcal{R}_{j_2} = \bigoplus_{j=|j_1-j_2|}^{j=j_1+j_2} \mathcal{R}_j$$

j taking integer and half-integer values.

→ Casimir invariants, Decomposition w.r.t. $osp(1|2)$ subalgebras, Embeddings of $osp(1|2)$.

For more details, see refs. [5, 30].

53 Superalgebra $sl(1|2)$

The superalgebra $sl(1|2) \simeq sl(2|1)$ is the (N=2) extended supersymmetric version of $sl(2)$ and contains four bosonic generators E^+, E^-, H, Z which form the Lie algebra $sl(2) \oplus U(1)$ and four fermionic generators $F^+, F^-, \bar{F}^+, \bar{F}^-$, whose commutation relations in the Cartan-Weyl basis read as

$$\begin{aligned}
[H, E^\pm] &= \pm E^\pm & [H, F^\pm] &= \pm \frac{1}{2} F^\pm & [H, \bar{F}^\pm] &= \pm \frac{1}{2} \bar{F}^\pm \\
[Z, H] &= [Z, E^\pm] = 0 & [Z, F^\pm] &= \frac{1}{2} F^\pm & [Z, \bar{F}^\pm] &= -\frac{1}{2} \bar{F}^\pm \\
[E^\pm, F^\pm] &= [E^\pm, \bar{F}^\pm] = 0 & [E^\pm, F^\mp] &= -F^\mp & [E^\pm, \bar{F}^\mp] &= \bar{F}^\mp \\
\{F^\pm, F^\pm\} &= \{\bar{F}^\pm, \bar{F}^\pm\} = 0 & \{F^\pm, F^\mp\} &= \{\bar{F}^\pm, \bar{F}^\mp\} = 0 & \{F^\pm, \bar{F}^\pm\} &= E^\pm \\
[E^+, E^-] &= 2H & \{F^\pm, \bar{F}^\mp\} &= Z \mp H
\end{aligned}$$

The three-dimensional matrix representation (fundamental representation) is given by

$$\begin{aligned}
H &= \begin{pmatrix} \frac{1}{2} & 0 & 0 \\ 0 & -\frac{1}{2} & 0 \\ 0 & 0 & 0 \end{pmatrix} & Z &= \begin{pmatrix} \frac{1}{2} & 0 & 0 \\ 0 & \frac{1}{2} & 0 \\ 0 & 0 & 1 \end{pmatrix} & E^+ &= \begin{pmatrix} 0 & 1 & 0 \\ 0 & 0 & 0 \\ 0 & 0 & 0 \end{pmatrix} & E^- &= \begin{pmatrix} 0 & 0 & 0 \\ 1 & 0 & 0 \\ 0 & 0 & 0 \end{pmatrix} \\
F^+ &= \begin{pmatrix} 0 & 0 & 0 \\ 0 & 0 & 0 \\ 0 & 1 & 0 \end{pmatrix} & \bar{F}^+ &= \begin{pmatrix} 0 & 0 & 1 \\ 0 & 0 & 0 \\ 0 & 0 & 0 \end{pmatrix} & F^- &= \begin{pmatrix} 0 & 0 & 0 \\ 0 & 0 & 0 \\ 1 & 0 & 0 \end{pmatrix} & \bar{F}^- &= \begin{pmatrix} 0 & 0 & 0 \\ 0 & 0 & 1 \\ 0 & 0 & 0 \end{pmatrix}
\end{aligned}$$

The quadratic and cubic Casimir operators are

$$\begin{aligned}
C_2 &= H^2 - Z^2 + E^- E^+ + F^- \bar{F}^+ - \bar{F}^- F^+ \\
C_3 &= (H^2 - Z^2)Z + E^- E^+ (Z - \frac{1}{2}) - \frac{1}{2} F^- \bar{F}^+ (H - 3Z + 1) \\
&\quad - \frac{1}{2} \bar{F}^- F^+ (H + 3Z + 1) + \frac{1}{2} E^- \bar{F}^+ F^+ + \frac{1}{2} \bar{F}^- F^- E^+
\end{aligned}$$

The irreducible representations of $sl(1|2)$ are characterized by the pair of labels (b, j) where j is a non-negative integer or half-integer and b an arbitrary complex number. The representations $\pi(b, j)$ with $b \neq \pm j$ are *typical* and have dimension $8j$. The representations $\pi(\pm j, j)$ are *atypical* and have dimension $4j + 1$. In the typical representation $\pi(b, j)$, the Casimir operators C_2 and C_3 have the eigenvalues $C_2 = j^2 - b^2$ and $C_3 = b(j^2 - b^2)$ while they are identically zero in the atypical representations $\pi(\pm j, j)$.

The typical representation $\pi(b, j)$ of $sl(1|2)$ decomposes under the even part $sl(2) \oplus U(1)$ for $j \geq 1$ as

$$\pi(b, j) = D_j(b) \oplus D_{j-1/2}(b - 1/2) \oplus D_{j-1/2}(b + 1/2) \oplus D_{j-1}(b)$$

the case $j = \frac{1}{2}$ reducing to

$$\pi(b, \frac{1}{2}) = D_{1/2}(b) \oplus D_0(b - 1/2) \oplus D_0(b + 1/2)$$

where $D_j(b)$ denotes the representation of $sl(2) \oplus U(1)$ with isospin j and hypercharge b .

The irreducible atypical representations $\pi_{\pm}(j) \equiv \pi(\pm j, j)$ of $sl(1|2)$ decompose under the even part $sl(2) \oplus U(1)$ as

$$\begin{aligned}\pi_+(j) &= D_j(j) \oplus D_{j-1/2}(j + 1/2) \\ \pi_-(j) &= D_j(-j) \oplus D_{j-1/2}(-j - 1/2)\end{aligned}$$

The not completely reducible atypical representations of $sl(1|2)$ decompose as *semi-direct* sums of $sl(1|2)$ irreducible (atypical) representations. They are of the following types:

$$\begin{aligned}\pi_{\pm}(j; j - 1/2) &\equiv \pi_{\pm}(j) \mathfrak{D} \pi_{\pm}(j - 1/2) \\ \pi_{\pm}(j - 1/2; j) &\equiv \pi_{\pm}(j - 1/2) \mathfrak{D} \pi_{\pm}(j) \\ \pi_{\pm}(j - 1/2, j + 1/2; j) &\equiv \pi_{\pm}(j - 1/2) \mathfrak{D} \pi_{\pm}(j) \mathfrak{E} \pi_{\pm}(j + 1/2) \\ \pi_{\pm}(j; j - 1/2, j + 1/2) &\equiv \pi_{\pm}(j - 1/2) \mathfrak{E} \pi_{\pm}(j) \mathfrak{D} \pi_{\pm}(j + 1/2) \\ \pi_{\pm}(j, j \pm 1; j \pm 1/2; j \pm 3/2) &\equiv \pi_{\pm}(j) \mathfrak{D} \pi_{\pm}(j \pm 1/2) \mathfrak{E} \pi_{\pm}(j \pm 1) \mathfrak{D} \pi_{\pm}(j \pm 3/2) \\ \pi_{\pm}(j; j - 1/2, j + 1/2; j) &\equiv \pi_{\pm}(j) \begin{array}{c} \mathfrak{D} \pi_{\pm}(j - 1/2) \mathfrak{D} \\ \mathfrak{D} \pi_{\pm}(j + 1/2) \mathfrak{D} \end{array} \pi_{\pm}(j)\end{aligned}$$

where the symbol \mathfrak{D} (resp. \mathfrak{E}) means that the representation space on the left (resp. on the right) is an invariant subspace of the whole representation space.

It is also possible to decompose the $sl(1|2)$ representations under the superprincipal $osp(1|2)$ subalgebra of $sl(1|2)$ (\rightarrow Embeddings of $osp(1|2)$). One obtains for the typical representations $\pi(b, j) = \mathcal{R}_j \oplus \mathcal{R}_{j-1/2}$ and for the irreducible atypical representations $\pi_{\pm}(j) = \mathcal{R}_j$ where \mathcal{R}_j denotes an irreducible $osp(1|2)$ -representation.

We give now the formulae of the tensor products of two $sl(1|2)$ representations $\pi(b_1, j_1)$ and $\pi(b_2, j_2)$. In what follows, we set $b = b_1 + b_2$, $j = j_1 + j_2$ and $\bar{j} = |j_1 - j_2|$. Moreover, the product of two irreducible representations will be called non-degenerate if it decomposes into a direct sum of irreducible representations; otherwise it is called degenerate.

- product of two typical representations

The product of two typical representations $\pi(b_1, j_1)$ and $\pi(b_2, j_2)$ is non-degenerate when $b \neq \pm(j - n)$ for $n = 0, 1, \dots, 2 \min(j_1, j_2)$. It is then given by

$$\pi(b_1, j_1) \otimes \pi(b_2, j_2) = \bigoplus_{n=0}^{2 \min(j_1, j_2)} \pi(b, j - n) \quad \bigoplus_{n=1}^{2 \min(j_1, j_2) - 1} \pi(b, j - n)$$

$$\begin{aligned}
& \bigoplus_{n=0}^{2 \min(j_1, j_2) - 1} \pi(b + \frac{1}{2}, j - \frac{1}{2} - n) \oplus \pi(b - \frac{1}{2}, j - \frac{1}{2} - n) \\
\pi(b_1, j_1) \otimes \pi(b_2, \frac{1}{2}) &= \pi(b, j_1 + \frac{1}{2}) \oplus \pi(b, j_1 - \frac{1}{2}) \oplus \pi(b + \frac{1}{2}, j_1) \oplus \pi(b - \frac{1}{2}, j_1) \\
\pi(b_1, \frac{1}{2}) \otimes \pi(b_2, \frac{1}{2}) &= \pi(b, 1) \oplus \pi(b + \frac{1}{2}, \frac{1}{2}) \oplus \pi(b - \frac{1}{2}, \frac{1}{2})
\end{aligned}$$

When the product is degenerate, one has

if $b = \pm j$

$$\pi(b, j) \oplus \pi(b \mp 1/2, j - 1/2) \text{ is replaced by } \pi_{\pm}(j - 1/2; j - 1, j; j - 1/2)$$

if $b = \pm \bar{j} \neq 0$

$$\pi(b, \bar{j}) \oplus \pi(b \pm 1/2, \bar{j} + 1/2) \text{ is replaced by } \pi_{\pm}(j; j - 1/2, j + 1/2; j)$$

if $b = \bar{j} = 0$

$$\pi(b + 1/2, 1/2) \oplus \pi(b - 1/2, 1/2) \text{ is replaced by } \pi(0; -1/2, 1/2; 0)$$

if $b = \pm(j - n)$ for $n = 1, \dots, 2 \min(j_1, j_2)$

$$\begin{aligned}
\pi(b \pm 1/2, j + 1/2 - n) \oplus \pi(b, j - n) \oplus \pi(b, j - n) \oplus \pi(b \mp 1/2, j - 1/2 - n) \\
\text{is replaced by } \pi_{\pm}(j - 1/2 - n; j - 1 - n, j - n; j - 1/2 - n) \\
\oplus \pi_{\pm}(j - n; j - 1/2 - n, j + 1/2 - n; j - n)
\end{aligned}$$

- product of a typical with an atypical representation

The non-degenerate product of a typical representation $\pi(b_1, j_1)$ with an atypical one $\pi_{\pm}(j_2)$ ($b_2 = \pm j_2$) is given by

$$\pi(b_1, j_1) \otimes \pi_{\pm}(j_2) = \begin{cases} \bigoplus_{n=0}^{2 \min(j_1, j_2) - 1} \pi(b, j - n) \oplus \pi(b \pm \frac{1}{2}, j - \frac{1}{2} - n) & \text{if } j_1 \leq j_2 \\ \bigoplus_{n=0}^{2 \min(j_1, j_2) - 1} \pi(b, j - n) \oplus \pi(b \pm \frac{1}{2}, j - \frac{1}{2} - n) \oplus \pi(b, |j_1 - j_2|) & \text{if } j_1 > j_2 \end{cases}$$

When the product $\pi(b_1, j_1) \otimes \pi_{+}(j_2)$ is degenerate, one has

if $b = -(j - n)$ for $n = 0, 1, \dots, 2 \min(j_1, j_2) - 1$

$$\begin{aligned}
\pi(b, j - n) \oplus \pi(b + 1/2, j - 1/2 - n) \text{ is replaced by} \\
\pi_{\pm}(j - 1/2 - n; j - 1 - n, j - n; j - 1/2 - n)
\end{aligned}$$

if $b = j - n$ for $n = 1, \dots, 2 \min(j_1, j_2)$

$$\begin{aligned}
\pi(b, j - n) \oplus \pi(b + 1/2, j + 1/2 - n) \text{ is replaced by} \\
\pi_{\pm}(j - n; j - 1/2 - n, j + 1/2 - n; j - n)
\end{aligned}$$

The case of the degenerate product $\pi(b_1, j_1) \otimes \pi_-(j_2)$ is similar.

- product of two atypical representations

The product of two atypical representations $\pi_\pm(j_1)$ and $\pi_\pm(j_2)$ is always non-degenerate.

It is given by

$$\pi_\pm(j_1) \otimes \pi_\pm(j_2) = \pi_\pm(j) \oplus \bigoplus_{n=0}^{2 \min(j_1, j_2) - 1} \pi(\pm(j + \frac{1}{2}), j - \frac{1}{2} - n)$$

$$\pi(j_1, j_1) \otimes \pi(-j_2, j_2) = \bigoplus_{n=0}^{2 \min(j_1, j_2) - 1} \pi(j_1 - j_2, j - n) \oplus \begin{cases} \pi(j_1 - j_2, j_1 - j_2) & \text{if } j_1 > j_2 \\ \pi(j_1 - j_2, j_2 - j_1) & \text{if } j_1 < j_2 \\ (0) & \text{if } j_1 = j_2 \end{cases}$$

→ Casimir invariants, Decomposition w.r.t. $sl(1|2)$ subalgebras, Embeddings of $sl(1|2)$.

For more details, see refs. [27, 30].

54 Superconformal algebra

For massless theory the concept of Fermi-Bose symmetry or supersymmetry requires the extension of the conformal Lie algebra including the generators of the supersymmetry transformations Q_α, S_α which transform bosonic fields into fermionic ones and vice-versa. The conformal algebra in four space-time dimensions is spanned by the 15 generators $M_{\mu\nu}, P_\mu, K_\mu$ and D (with the greek labels running from 0 to 3). The generators $M_{\mu\nu}$ and P_μ span the Poincaré algebra and their commutation relations are given in "Supersymmetry algebra" (→), while K_μ and D are respectively the generators of the conformal transformations and of the dilatation. The commutation relations of the $N = 1$ superconformal algebra read as (the metric is $g_{\mu\nu} = \text{diag}(1, -1, -1, -1)$):

$$\begin{aligned} [M_{\mu\nu}, K_\rho] &= i(g_{\nu\rho}K_\mu - g_{\mu\rho}K_\nu) & [P_\mu, K_\nu] &= 2i(g_{\mu\nu}D - M_{\mu\nu}) \\ [D, M_{\mu\nu}] &= 0 & [D, P_\mu] &= -iP_\mu \\ [K_\mu, K_\nu] &= 0 & [D, K_\mu] &= iK_\mu \\ [M_{\mu\nu}, Q_a] &= -\frac{1}{2}(\Sigma_{\mu\nu})_a{}^b Q_b & [M_{\mu\nu}, S_a] &= -\frac{1}{2}(\Sigma_{\mu\nu})_a{}^b S_b \\ [P_\mu, Q_a] &= 0 & [P_\mu, S_a] &= -(\gamma_\mu)_a{}^b Q_b \\ [K_\mu, Q_a] &= -(\gamma_\mu)_a{}^b S_b & [K_\mu, S_a] &= 0 \\ [D, Q_a] &= -\frac{1}{2}iQ_a & [D, S_a] &= \frac{1}{2}iS_a \\ \{Q_a, Q_b\} &= 2(\gamma_\mu C)_{ab} P^\mu & \{S_a, S_b\} &= 2(\gamma_\mu C)_{ab} K^\mu \\ \{Q_a, S_b\} &= (\Sigma_{\mu\nu} C)_{ab} M^{\mu\nu} + 2iC_{ab} D & & \\ &+ 3i(\gamma_5 C)_{ab} Y & & \\ [Y, Q_a] &= i(\gamma_5)_a{}^b Q_b & [Y, S_a] &= -i(\gamma_5)_a{}^b S_b \\ [Y, M_{\mu\nu}] &= [Y, D] = 0 & [Y, P_\mu] &= [Y, K_\mu] = 0 \end{aligned}$$

where γ are the Dirac matrices in Majorana representation, C is the charge conjugation matrix and Y is the generator of the (chiral) $U(1)$. The transformations of Q_a and S_a under $M_{\mu\nu}$ show that the Q_a and S_a are spinors. The superconformal algebra contains the super-Poincaré as supersubalgebra, however in the conformal case there are no central charges for $N > 1$.

Let us emphasize that the superconformal algebra is isomorphic to the simple Lie superalgebra $su(2, 2|N)$, real form of $sl(4|N)$.

→ Spinors, Supersymmetry algebra.

For more details, see refs. [44, 51].

55 Supergroups

In order to construct the supergroup or group with Grassmann structure associated to a (simple) superalgebra $\mathcal{A} = \mathcal{A}_{\bar{0}} \oplus \mathcal{A}_{\bar{1}}$, one starts from the complex Grassmann algebra (\rightarrow) $\Gamma(n)$ of order n with n generators $1, \theta_1, \dots, \theta_n$ satisfying $\{\theta_i, \theta_j\} = 0$. The element

$$\eta = \sum_{m \geq 0} \sum_{i_1 < \dots < i_m} \eta_{i_1 \dots i_m} \theta_{i_1} \dots \theta_{i_m}$$

is called even (resp. odd) if each complex coefficient $\eta_{i_1 \dots i_m}$ in the above expression of η corresponds to an even (resp. odd) value of m . As a vector space, one decomposes $\Gamma(n)$ as $\Gamma(n) = \Gamma(n)_{\bar{0}} \oplus \Gamma(n)_{\bar{1}}$ with $\Gamma(n)_{\bar{0}}$ (resp. $\Gamma(n)_{\bar{1}}$) made of homogeneous even (resp. odd) elements.

The Grassmann envelope $A(\Gamma)$ of \mathcal{A} consists of formal linear combinations $\sum_i \eta_i a_i$ where $\{a_i\}$ is a basis of \mathcal{A} and $\eta_i \in \Gamma(n)$ such that for a fixed index i , the elements a_i and η_i are both even or odd. The commutator between two arbitrary elements $X = \sum_i \eta_i a_i$ and $Y = \sum_j \eta'_j a_j$ is naturally defined by $[X, Y] = \sum_{ij} \eta_i \eta'_j \llbracket a_i, a_j \rrbracket$ where $\llbracket a_i, a_j \rrbracket$ means the supercommutator in \mathcal{A} . This commutator confers to the Grassmann envelope $A(\Gamma)$ of \mathcal{A} a *Lie algebra* structure.

The relation between a supergroup and its superalgebra is analogous to the Lie algebra case: the supergroup A associated to the superalgebra \mathcal{A} is the exponential mapping of the Grassmann envelope $A(\Gamma)$ of \mathcal{A} , the even generators of the superalgebra \mathcal{A} corresponding to even parameters (that is even elements of the Grassmann algebra) and the odd generators of \mathcal{A} to odd parameters (that is odd elements of the Grassmann algebra).

The above approach is due to Berezin. In particular, the case of $osp(1|2)$ is worked out explicitly in ref. [5]. On classical supergroups, see also refs. [21, 22].

→ Grassmann algebras.

56 Supergroups of linear transformations

Let $\Gamma = \Gamma_{\bar{0}} \oplus \Gamma_{\bar{1}}$ be a Grassmann algebra (\rightarrow) over a field $\mathbb{K} = \mathbb{R}$ or \mathbb{C} and consider the set of $(m+n) \times (m+n)$ even supermatrices (\rightarrow) of the form

$$M = \begin{pmatrix} A & B \\ C & D \end{pmatrix}$$

where A, B, C, D are $m \times m$, $m \times n$, $n \times m$ and $n \times n$ submatrices respectively, with even entries in $\Gamma_{\bar{0}}$ for A, D and odd entries in $\Gamma_{\bar{1}}$ for B, C .

The *general linear supergroup* $GL(m|n; \mathbb{K})$ is the supergroup of even invertible supermatrices M , the product law being the usual matrix multiplication.

The transposition and adjoint operations allow us to define the classical subsupergroups of $GL(m|n; \mathbb{K})$ corresponding to the classical superalgebras.

The special linear supergroup $SL(m|n; \mathbb{K})$ is the subsupergroup of supermatrices $M \in GL(m|n; \mathbb{K})$ such that $\text{sdet}(M) = 1$.

The unitary and superunitary supergroups $U(m|n)$ and $sU(m|n)$ are the subsupergroups of supermatrices $M \in GL(m|n; \mathbb{C})$ such that $MM^\dagger = 1$ and $MM^\ddagger = 1$ respectively (for the notations \dagger and \ddagger , \rightarrow Supermatrices).

The orthosymplectic supergroup $OSP(m|n; \mathbb{K})$ is the subsupergroup of supermatrices $M \in GL(m|n; \mathbb{K})$ such that $M^{st}HM = H$ where ($n = 2p$)

$$H = \begin{pmatrix} \mathbb{I}_m & 0 \\ 0 & \mathbb{J}_{2p} \end{pmatrix} \quad \text{and} \quad \mathbb{J}_{2p} = \begin{pmatrix} 0 & \mathbb{I}_p \\ -\mathbb{I}_p & 0 \end{pmatrix}$$

The compact forms are $USL(m|n)$ and $sOSP(m|n)$, subsupergroups of supermatrices $M \in GL(m|n; \mathbb{C})$ such that $\text{sdet}(M) = 1$, $MM^\dagger = 1$ and $M^{st}HM = H$, $MM^\ddagger = 1$ respectively.

Finally the strange supergroups are defined as follows. The supergroup $P(n)$ is the subsupergroup of supermatrices $M \in GL(n|n; \mathbb{K})$ such that $\text{sdet}(M) = 1$ and $M\mathbb{J}_{2n}M^{st} = \mathbb{J}_{2n}$ with \mathbb{J}_{2n} defined above. The supergroup $Q(n)$ is the subsupergroup of supermatrices $M \in GL(n|n; \mathbb{K})$ with $A = D$ and $B = C$ such that $\text{tr} \ln((A - B)^{-1}(A + B)) = 0$.

For more details, see ref. [34].

57 Supermatrices

Definition: A matrix M is called a complex (resp. real) *supermatrix* if its entries have values in a complex (resp. real) Grassmann algebra $\Gamma = \Gamma_{\bar{0}} \oplus \Gamma_{\bar{1}}$. More precisely, consider

the set of $(m+n) \times (p+q)$ supermatrices M of the form

$$M = \begin{pmatrix} A & B \\ C & D \end{pmatrix}$$

where A, B, C, D are $m \times p$, $m \times q$, $n \times p$ and $n \times q$ submatrices respectively. The supermatrix M is called *even* (or of degree 0) if $A, D \in \Gamma_{\bar{0}}$ and $B, C \in \Gamma_{\bar{1}}$, while it is called *odd* (or of degree 1) if $A, D \in \Gamma_{\bar{1}}$ and $B, C \in \Gamma_{\bar{0}}$.

The product of supermatrices is defined as the product of matrices: M and M' being two $(m+n) \times (p+q)$ and $(p+q) \times (r+s)$ supermatrices, the entries of the $(m+n) \times (r+s)$ supermatrix MM' are given by

$$(MM')_{ij} = \sum_{k=1}^{p+q} M_{ik} M'_{kj}$$

Since the Grassmann algebra Γ is associative, the product of supermatrices is also associative.

From now on, we will consider only square supermatrices, that is such that $m = p$ and $n = q$. The set of $(m+n) \times (m+n)$ complex (resp. real) square supermatrices is denoted by $M(m|n; \mathbb{C})$ (resp. $M(m|n; \mathbb{R})$).

A square supermatrix M is said to be invertible if there exists a square supermatrix M' such that $MM' = M'M = I$ where I is the unit supermatrix (even supermatrix with zero off-diagonal entries and diagonal entries equal to the unit 1 of the Grassmann algebra Γ).

Definition: The *general linear supergroup* $GL(m|n; \mathbb{C})$ (resp. $GL(m|n; \mathbb{R})$) is the supergroup of even invertible complex (resp. real) supermatrices, the group law being the product of supermatrices.

The usual operations of transposition, determinant, trace, adjoint are defined as follows in the case of supermatrices.

Let $M \in M(m|n; \mathbb{C})$ be a complex square supermatrix of the form

$$M = \begin{pmatrix} A & B \\ C & D \end{pmatrix}$$

The transpose and supertranspose of M are defined by:

$$M^t = \begin{pmatrix} A^t & C^t \\ B^t & D^t \end{pmatrix} \quad \text{transpose}$$

$$M^{st} = \begin{pmatrix} A^t & (-1)^{\deg M} C^t \\ -(-1)^{\deg M} B^t & D^t \end{pmatrix} \quad \text{supertranspose}$$

Explicitly, one finds

$$M^{st} = \begin{pmatrix} A^t & C^t \\ -B^t & D^t \end{pmatrix} \quad \text{if } M \text{ is even}$$

$$M^{st} = \begin{pmatrix} A^t & -C^t \\ B^t & D^t \end{pmatrix} \quad \text{if } M \text{ is odd}$$

It follows that

$$\begin{aligned} ((M)^{st})^{st} &= \begin{pmatrix} A & -B \\ -C & D \end{pmatrix} \\ (((M)^{st})^{st})^{st} &= M \\ (MN)^{st} &= (-1)^{\deg M \cdot \deg N} N^{st} M^{st} \end{aligned}$$

but $(MN)^t \neq N^t M^t$.

The supertrace of M is defined by

$$\text{str}(M) = \text{tr}(A) - (-1)^{\deg M} \text{tr}(D) = \begin{cases} \text{tr}(A) - \text{tr}(D) & \text{if } M \text{ is even} \\ \text{tr}(A) + \text{tr}(D) & \text{if } M \text{ is odd} \end{cases}$$

One has the following properties for the supertrace:

$$\begin{aligned} \text{str}(M + N) &= \text{str}(M) + \text{str}(N) \quad \text{if } \deg M = \deg N \\ \text{str}(MN) &= (-1)^{\deg M \cdot \deg N} \text{str}(M) \text{str}(N) \\ \text{str}(M^{st}) &= \text{str}(M) \end{aligned}$$

If M is even invertible, one defines the superdeterminant (or Berezinian) of M by

$$\text{sdet}(M) = \frac{\det(A - BD^{-1}C)}{\det(D)} = \frac{\det(A)}{\det(D - CA^{-1}B)}$$

Notice that M being an even invertible matrix, the inverse matrices A^{-1} and D^{-1} exist.

One has the following properties for the superdeterminant:

$$\begin{aligned} \text{sdet}(MN) &= \text{sdet}(M) \text{sdet}(N) \\ \text{sdet}(M^{st}) &= \text{sdet}(M) \\ \text{sdet}(\exp(M)) &= \exp(\text{str}(M)) \end{aligned}$$

The adjoint operations on the supermatrix M are defined by

$$\begin{aligned} M^\dagger &= (M^t)^* \quad \text{adjoint} \\ M^\ddagger &= (M^{st})^\# \quad \text{superadjoint} \end{aligned}$$

One has

$$\begin{aligned}
(MN)^\dagger &= N^\dagger M^\dagger \\
(MN)^\ddagger &= N^\ddagger M^\ddagger \\
(M^\dagger)^\dagger &= M \quad \text{and} \quad (M^\ddagger)^\ddagger = M \\
\text{sdet}(M^\dagger) &= \overline{\text{sdet}(M)} = (\text{sdet}(M))^*
\end{aligned}$$

where the bar denotes the usual complex conjugation and the star the Grassmann complex conjugation (\rightarrow Grassmann algebra).

\rightarrow Supergroups of linear transformations.

For more details, see refs. [34, 3].

58 Superspace and superfields

It is fruitful to consider the supergroup associated to the supersymmetry algebra, the super-Poincaré group. A group element g is then given by the exponential of the supersymmetry algebra generators. However, since Q_α and $\bar{Q}_{\dot{\alpha}}$ are fermionic, the corresponding parameters have to be anticommuting (\rightarrow Grassmann algebra). More precisely, a group element g with parameters $x^\mu, \omega^{\mu\nu}, \theta^\alpha, \bar{\theta}^{\dot{\alpha}}$ is given by

$$g(x^\mu, \omega^{\mu\nu}, \theta^\alpha, \bar{\theta}^{\dot{\alpha}}) = \exp i(x^\mu P_\mu + \frac{1}{2}\omega^{\mu\nu} M_{\mu\nu} + \theta^\alpha Q_\alpha + \bar{Q}_{\dot{\alpha}} \bar{\theta}^{\dot{\alpha}})$$

One defines the superspace as the coset space of the super-Poincaré group by the Lorentz group, parametrized by the coordinates $x^\mu, \theta^\alpha, \bar{\theta}^{\dot{\alpha}}$ subject to the condition $\bar{\theta}^{\dot{\alpha}} = (\theta^\alpha)^*$. The multiplication of group elements is induced by the supersymmetry algebra:

$$g(x^\mu, \theta^\alpha, \bar{\theta}^{\dot{\alpha}}) g(y^\mu, \zeta^\alpha, \bar{\zeta}^{\dot{\alpha}}) = g(x^\mu + y^\mu + i\theta\sigma^\mu\bar{\zeta} - i\zeta\sigma^\mu\bar{\theta}, \theta + \zeta, \bar{\theta} + \bar{\zeta})$$

If group element multiplication is considered as a *left* action, one can write infinitesimally

$$g(y^\mu, \zeta^\alpha, \bar{\zeta}^{\dot{\alpha}}) g(x^\mu, \theta^\alpha, \bar{\theta}^{\dot{\alpha}}) = [1 - iy^\mu P_\mu - i\zeta^\alpha Q_\alpha - i\bar{\zeta}_{\dot{\alpha}} \bar{Q}^{\dot{\alpha}}] g(x^\mu, \theta^\alpha, \bar{\theta}^{\dot{\alpha}})$$

where the differential operators

$$Q_\alpha = i\frac{\partial}{\partial\theta^\alpha} - (\sigma^\mu\bar{\theta})_\alpha\partial_\mu \quad \text{and} \quad \bar{Q}_{\dot{\alpha}} = -i\frac{\partial}{\partial\bar{\theta}^{\dot{\alpha}}} + (\theta\sigma^\mu)_{\dot{\alpha}}\partial_\mu$$

are the supersymmetry generators of the supersymmetry algebra (\rightarrow).

If group element multiplication is considered as a *right* action, one has infinitesimally

$$g(x^\mu, \theta^\alpha, \bar{\theta}^{\dot{\alpha}}) g(y^\mu, \zeta^\alpha, \bar{\zeta}^{\dot{\alpha}}) = [1 - iy^\mu P_\mu - i\zeta^\alpha D_\alpha - i\bar{\zeta}_{\dot{\alpha}} \bar{D}^{\dot{\alpha}}] g(x^\mu, \theta^\alpha, \bar{\theta}^{\dot{\alpha}})$$

where the differential operators

$$D_\alpha = i\frac{\partial}{\partial\theta^\alpha} + (\sigma^\mu\bar{\theta})_\alpha\partial_\mu \quad \text{and} \quad \bar{D}_{\dot{\alpha}} = -i\frac{\partial}{\partial\bar{\theta}^{\dot{\alpha}}} - (\theta\sigma^\mu)_{\dot{\alpha}}\partial_\mu$$

satisfy the following algebra

$$\begin{aligned} \{D_\alpha, \bar{D}_{\dot{\beta}}\} &= -2i\sigma^\mu_{\alpha\dot{\beta}}\partial_\mu \\ \{D_\alpha, D_\beta\} &= \{\bar{D}_{\dot{\alpha}}, \bar{D}_{\dot{\beta}}\} = 0 \end{aligned}$$

and anticommute with the Q_α and $\bar{Q}_{\dot{\alpha}}$ generators.

Unlike the Q generators, the D generators behave like *covariant derivatives* under the super-Poincaré group.

One defines a *superfield* \mathcal{F} as a function of the superspace. Since the parameters $\theta^\alpha, \bar{\theta}^{\dot{\alpha}}$ are Grassmann variables, a Taylor expansion of \mathcal{F} in $\theta, \bar{\theta}$ has a finite number of terms:

$$\begin{aligned} \mathcal{F}(x, \theta, \bar{\theta}) &= f(x) + \theta\phi(x) + \bar{\theta}\bar{\chi}(x) + \theta\theta m(x) + \bar{\theta}\bar{\theta}n(x) \\ &\quad + \theta\sigma^\mu\bar{\theta}A_\mu(x) + \theta\theta\bar{\theta}\bar{\lambda}(x) + \bar{\theta}\bar{\theta}\theta\lambda'(x) + \theta\theta\bar{\theta}\bar{\theta}d(x) \end{aligned}$$

Notice the very important property that the product of two superfields is again a superfield.

Under a superspace transformation, the variation of the superfield \mathcal{F} is given by the action of the supersymmetry generators Q_α and $\bar{Q}_{\dot{\alpha}}$:

$$\delta\mathcal{F}(x, \theta, \bar{\theta}) = -i(\zeta Q + \bar{Q}\bar{\zeta})\mathcal{F}$$

The superfield \mathcal{F} forms a representation of the supersymmetry algebra. However, this representation is not irreducible. Irreducible representations can be obtained by imposing constraints on the superfields. The two main examples are the scalar (chiral or antichiral) and the vector superfields.

- The *chiral* superfield \mathcal{F} is defined by the covariant constraint $\bar{D}_{\dot{\alpha}}\mathcal{F} = 0$. It follows that the chiral superfield \mathcal{F} can be expressed, in terms of $y^\mu = x^\mu - i\theta\sigma^\mu\bar{\theta}$ and θ , as

$$\mathcal{F} = A(y) + 2\theta\psi(y) + \theta\theta F(y)$$

The transformation law for the chiral superfield is therefore

$$\begin{aligned} \delta A &= 2\zeta\psi \\ \delta\psi &= -i\sigma^\mu\bar{\zeta}\partial_\mu A + \zeta F \\ \delta F &= 2i\partial_\mu\psi\sigma^\mu\bar{\zeta} \end{aligned}$$

- In the same way, the *antichiral* superfield \mathcal{F} is defined by the covariant constraint $D_\alpha \mathcal{F} = 0$. The antichiral superfield \mathcal{F} can be expressed, in terms of $(y^\mu)^\dagger = x^\mu + i\theta\sigma^\mu\bar{\theta}$ and $\bar{\theta}$, as

$$\mathcal{F} = A^*(y^\dagger) + 2\bar{\theta}\bar{\psi}(y^\dagger) + \bar{\theta}\bar{\theta}F^*(y^\dagger)$$

and the transformation law for the antichiral superfield is

$$\begin{aligned}\delta A^\dagger &= 2\bar{\psi}\bar{\zeta} \\ \delta\bar{\psi} &= i\zeta\sigma^\mu\partial_\mu A^\dagger + F^\dagger\bar{\zeta} \\ \delta F^\dagger &= -2i\zeta\sigma^\mu\partial_\mu\bar{\psi}\end{aligned}$$

- The *vector* superfield \mathcal{F} is defined by the reality constraint $\mathcal{F}^\dagger = \mathcal{F}$. In terms of $x, \theta, \bar{\theta}$, it takes the form (with standard notations)

$$\begin{aligned}\mathcal{F}(x, \theta, \bar{\theta}) &= C(x) + i\theta\chi(x) - i\bar{\theta}\bar{\chi}(x) + \frac{i}{2}\theta\theta(M(x) + iN(x)) - \frac{i}{2}\bar{\theta}\bar{\theta}(M(x) - iN(x)) \\ &\quad - \theta\sigma^\mu\bar{\theta}A_\mu(x) + i\theta\bar{\theta}(\bar{\lambda}(x) + \frac{i}{2}\bar{\sigma}^\mu\partial_\mu\chi(x)) - i\bar{\theta}\theta(\lambda(x) + \frac{i}{2}\sigma^\mu\partial_\mu\bar{\chi}(x)) \\ &\quad + \frac{1}{2}\theta\theta\bar{\theta}\bar{\theta}(D(x) + \frac{1}{2}\square C(x))\end{aligned}$$

where C, M, N, D are real scalar fields, A_μ is a real vector field and χ, λ are spinor fields.

→ Grassmann algebras, Spinors, Supersymmetry algebra: definition, representations.
For more details, see refs. [2, 44, 51].

59 Supersymmetry algebra: definition

The concept of Fermi-Bose symmetry or supersymmetry requires the extension of the Poincaré Lie algebra including the generators of the supersymmetry transformations Q_α and $\bar{Q}_{\dot{\alpha}}$, which are fermionic, that is transform bosonic fields into fermionic ones and vice-versa. The supersymmetry generators Q_α and $\bar{Q}_{\dot{\alpha}}$ behave like (1/2,0) and (0,1/2) spinors under the Lorentz group.

The metric being $g_{\mu\nu} = \text{diag}(1, -1, -1, -1)$, the $N = 1$ supersymmetry algebra takes the following form in two-spinor notation (the indices $\mu, \nu, \dots = 0, 1, 2, 3$ are space-time indices while the indices $\alpha, \beta = 1, 2$ and $\dot{\alpha}, \dot{\beta} = \dot{1}, \dot{2}$ are spinorial ones):

$$\begin{aligned}[M_{\mu\nu}, M_{\rho\sigma}] &= i(-g_{\nu\sigma}M_{\mu\rho} + g_{\nu\rho}M_{\mu\sigma} + g_{\mu\sigma}M_{\nu\rho} - g_{\mu\rho}M_{\nu\sigma}) \\ [M_{\mu\nu}, P_\rho] &= i(g_{\nu\rho}P_\mu - g_{\mu\rho}P_\nu) \\ [P_\mu, P_\nu] &= 0 \\ [M_{\mu\nu}, Q_\alpha] &= -\frac{1}{2}(\sigma_{\mu\nu})_\alpha{}^\beta Q_\beta & [M_{\mu\nu}, \bar{Q}_{\dot{\alpha}}] &= -\frac{1}{2}\bar{Q}_{\dot{\beta}}(\bar{\sigma}_{\mu\nu})^{\dot{\beta}}{}_{\dot{\alpha}} \\ [P_\mu, Q_\alpha] &= [P_\mu, \bar{Q}_{\dot{\alpha}}] = 0 \\ \{Q_\alpha, Q_\beta\} &= \{\bar{Q}_{\dot{\alpha}}, \bar{Q}_{\dot{\beta}}\} = 0 & \{Q_\alpha, \bar{Q}_{\dot{\beta}}\} &= 2\sigma^\mu_{\alpha\dot{\beta}}P_\mu\end{aligned}$$

where the σ^i are the Pauli matrices, $\bar{\sigma}^i = -\sigma^i$ for $i = 1, 2, 3$ and $\sigma^0 = \bar{\sigma}^0 = \mathbb{I}$. The matrices $\frac{1}{2}\sigma^{\mu\nu}$ and $\frac{1}{2}\bar{\sigma}^{\mu\nu}$ are the generators of the Lorentz group in the two fundamental spinorial representations: $\sigma^{\mu\nu} = \frac{i}{2}(\sigma^\mu\bar{\sigma}^\nu - \sigma^\nu\bar{\sigma}^\mu)$ and $\bar{\sigma}^{\mu\nu} = \frac{i}{2}(\bar{\sigma}^\mu\sigma^\nu - \bar{\sigma}^\nu\sigma^\mu)$.

In four-spinor notation, the $N = 1$ supersymmetry algebra reads as:

$$\begin{aligned} [M_{\mu\nu}, Q_a] &= -\frac{1}{2}(\Sigma_{\mu\nu})_a{}^b Q_b \\ [P_\mu, Q_a] &= 0 \\ \{Q_a, Q_b\} &= 2(\gamma_\mu C)_{ab} P^\mu \end{aligned}$$

where $Q_a = \begin{pmatrix} Q_\alpha \\ \bar{Q}^{\dot{\alpha}} \end{pmatrix}$ is a Majorana spinor ($a = 1, 2, 3, 4$), γ^μ are the Dirac matrices in the Majorana representation, C is the charge conjugation matrix and the $\Sigma^{\mu\nu}$ are the generators of the Lorentz group in the representation $(1/2, 0) \oplus (0, 1/2)$: $\Sigma^{\mu\nu} = \frac{i}{2}(\gamma^\mu\gamma^\nu - \gamma^\nu\gamma^\mu)$ (\rightarrow Spinors).

There is an extended version of this algebra if one considers many supersymmetry generators $Q_\alpha^A, \bar{Q}_{\dot{\alpha}}^A$ with $A = 1, \dots, N$ transforming under some symmetry group. The extended N -supersymmetry algebra becomes then in two-spinor notation:

$$\begin{aligned} [M_{\mu\nu}, Q_\alpha^A] &= -\frac{1}{2}(\sigma_{\mu\nu})_\alpha{}^\beta Q_\beta^A & [M_{\mu\nu}, \bar{Q}_{\dot{\alpha}}^A] &= -\frac{1}{2}\bar{Q}_{\dot{\beta}}^A(\bar{\sigma}_{\mu\nu})^{\dot{\beta}}{}_{\dot{\alpha}} \\ [P_\mu, Q_\alpha^A] &= 0 & [P_\mu, \bar{Q}_{\dot{\alpha}}^A] &= 0 \\ \{Q_\alpha^A, Q_\beta^B\} &= 2\varepsilon_{\alpha\beta} Z^{AB} & \{\bar{Q}_{\dot{\alpha}}^A, \bar{Q}_{\dot{\beta}}^B\} &= -2\varepsilon_{\dot{\alpha}\dot{\beta}}(Z^{AB})^\dagger \\ \{Q_\alpha^A, \bar{Q}_{\dot{\beta}}^B\} &= 2\sigma^\mu_{\alpha\dot{\beta}} P_\mu \delta_{AB} & & \\ [T_i, T_j] &= i f_{ij}^k T_k & [T_i, M_{\mu\nu}] &= [T_i, P_\mu] = 0 \\ [T_i, Q_\alpha^A] &= (\zeta_i)^A{}_B Q_\alpha^B & [T_i, \bar{Q}_{\dot{\alpha}}^A] &= -\bar{Q}_{\dot{\alpha}}^B (\zeta_i)_B{}^A \\ [Z^{AB}, \text{anything}] &= 0 & & \end{aligned}$$

while in four-spinor notation it takes the form (for the relations involving the supersymmetry generators):

$$\begin{aligned} [M_{\mu\nu}, Q_a^A] &= -\frac{1}{2}(\Sigma_{\mu\nu})_a{}^b Q_b^A \\ [P_\mu, Q_a^A] &= 0 \\ \{Q_a^A, Q_b^B\} &= 2(\gamma^\mu C)_{ab} P_\mu \delta^{AB} + C_{ab} U^{AB} + (\gamma_5 C)_{ab} V^{AB} \\ [T_i, Q_a^A] &= (\xi_i)^A{}_B Q_a^B + (i\zeta_i)^A{}_B (\gamma_5)_a{}^b Q_b^B \\ [U^{AB}, \text{anything}] &= [V^{AB}, \text{anything}] = 0 \end{aligned}$$

U^{AB} and V^{AB} being central charges and the matrices ξ_i, ζ_i having to satisfy $(\xi_i + i\zeta_i) + (\xi_i + i\zeta_i)^\dagger = 0$.

Actually, the number of central charges $U^{AB} = -U^{BA}$ and $V^{AB} = -V^{BA}$ present in the algebra imposes constraints on the symmetry group of the matrices ξ_i and ζ_i . If there is no central charge this symmetry group is $U(N)$, otherwise it is $USp(2N)$, compact form of $Sp(2N)$.

For more details, see refs. [2, 44, 51].

60 Supersymmetry algebra: representations

We will only consider the finite dimensional representations of the N -supersymmetry algebra (\rightarrow Supersymmetry algebra: definition). Since the translation generators P^μ commute with the supersymmetry generators Q_α^A and $\bar{Q}_{\dot{\alpha}}^A$, the representations of the N -supersymmetry algebra are labelled by the mass M if M^2 is the eigenvalue of the Casimir operator $P^2 = P^\mu P_\mu$.

If N_F denotes the fermion number operator, the states $|B\rangle$ such that $(-1)^{N_F}|B\rangle = |B\rangle$ are bosonic states while the states $|F\rangle$ such that $(-1)^{N_F}|F\rangle = -|F\rangle$ are fermionic ones. In a finite dimensional representation, one has $\text{tr}(-1)^{N_F} = 0$, from which it follows that *the finite dimensional representations of the supersymmetry algebra contain an equal number of bosonic and fermionic states.*

For the massive representations ($M \neq 0$), the supersymmetry algebra in the rest frame, where $P^\mu = (M, 0, 0, 0)$, takes the form (with vanishing central charges)

$$\begin{aligned} \{Q_\alpha^A, \bar{Q}_\beta^B\} &= 2M\delta_{\alpha\beta}\delta_{AB} \\ \{Q_\alpha^A, Q_\beta^B\} &= \{\bar{Q}_{\dot{\alpha}}^A, \bar{Q}_{\dot{\beta}}^B\} = 0 \end{aligned}$$

with $A, B = 1, \dots, N$.

The rescaled operators $a_\alpha^A = Q_\alpha^A/\sqrt{2M}$ and $(a_\alpha^A)^\dagger = \bar{Q}_{\dot{\alpha}}^A/\sqrt{2M}$ satisfy the Clifford algebra (\rightarrow) in $2N$ dimensions. The states of a representation can be arranged into spin multiplets of some ground state – or vacuum – $|\Omega\rangle$ of given spin s , annihilated by the a_α^A operators. The other states of the representation are given by

$$|a_{\alpha_1}^{A_1} \dots a_{\alpha_n}^{A_n}\rangle = (a_{\alpha_1}^{A_1})^\dagger \dots (a_{\alpha_n}^{A_n})^\dagger |\Omega\rangle$$

When the ground state $|\Omega\rangle$ has spin s , the maximal spin state has spin $s + \frac{1}{2}N$ and the minimal spin state has spin 0 if $s \leq \frac{1}{2}N$ or $s - \frac{1}{2}N$ if $s \geq \frac{1}{2}N$.

When the ground state $|\Omega\rangle$ has spin zero, the total number of states is equal to 2^{2N} with 2^{2N-1} fermionic states (constructed with an odd number of $(a_\alpha^A)^\dagger$ operators) and 2^{2N-1} bosonic states (constructed with an even number of $(a_\alpha^A)^\dagger$ operators). The maximal spin

is $\frac{1}{2}N$ and the minimal spin is 0.

In the case $N = 1$, when the ground state $|\Omega\rangle$ has spin j , the states of the multiplet have spins $(j, j + \frac{1}{2}, j - \frac{1}{2}, j)$. When the ground state $|\Omega\rangle$ has spin 0, the multiplet has two states of spin 0 and one state of spin $\frac{1}{2}$.

The following table gives the dimensions of the massive representations with ground states Ω_s (of spin s) for $N = 1, 2, 3, 4$.

| | | | | | | | | | | |
|---------|--|---------------|------------|----------------|------------|----------------|---------------|---------------|----------------|---------|
| | | spin | Ω_0 | $\Omega_{1/2}$ | Ω_1 | $\Omega_{3/2}$ | | spin | Ω_0 | |
| $N = 1$ | | 0 | 2 | 1 | | | | 0 | 42 | $N = 4$ |
| | | $\frac{1}{2}$ | 1 | 2 | 1 | | | $\frac{1}{2}$ | 48 | |
| | | 1 | | 1 | 2 | 1 | | 1 | 27 | |
| | | $\frac{3}{2}$ | | | 1 | 2 | | $\frac{3}{2}$ | 8 | |
| | | 2 | | | | 1 | | 2 | 1 | |
| $N = 2$ | | spin | Ω_0 | $\Omega_{1/2}$ | Ω_1 | | spin | Ω_0 | $\Omega_{1/2}$ | |
| | | 0 | 5 | 4 | 1 | | 0 | 14 | 14 | $N = 3$ |
| | | $\frac{1}{2}$ | 4 | 6 | 4 | | $\frac{1}{2}$ | 14 | 20 | |
| | | 1 | 1 | 4 | 6 | | 1 | 6 | 15 | |
| | | $\frac{3}{2}$ | | 1 | 4 | | $\frac{3}{2}$ | 1 | 6 | |
| | | 2 | | | 1 | | 2 | | 1 | |

We consider now the massless representations corresponding to $P^2 = 0$. In a reference frame where $P^\mu = (E, 0, 0, E)$, the supersymmetry algebra become

$$\begin{aligned} \{Q_\alpha^A, \bar{Q}_\beta^B\} &= 4E\delta^{AB}\delta_{\alpha\dot{\beta}, 1i} \\ \{Q_\alpha^A, Q_\beta^B\} &= \{\bar{Q}_{\dot{\alpha}}^A, \bar{Q}_{\dot{\beta}}^B\} = 0 \end{aligned}$$

The rescaled operators $a^A = Q_1^A/\sqrt{4E}$ and $(a^A)^\dagger = \bar{Q}_1^A/\sqrt{4E}$ satisfy the Clifford algebra in N dimensions while the operators $a'^A = Q_2^A/\sqrt{4E}$ and $(a'^A)^\dagger = \bar{Q}_2^A/\sqrt{4E}$ mutually anticommute and act as zero on the representation states. A representation of the supersymmetry algebra is therefore characterized by a Clifford ground state $|\Omega\rangle$ labelled by the energy E and the helicity λ and annihilated by the a^A operators. The other states of the representation are given by

$$|a^{A_1} \dots a^{A_n}\rangle = (a^{A_1})^\dagger \dots (a^{A_n})^\dagger |\Omega\rangle$$

The number of states with helicity $\lambda + n$ with $0 \leq n \leq \frac{1}{2}N$ is $\binom{N}{2n}$. The total number of states is therefore 2^N with 2^{N-1} bosonic states and 2^{N-1} fermionic states.

For more details on the supersymmetry representations (in particular when the central charges are not zero), see refs. [2, 44, 51].

61 Unitary superalgebras

The superalgebras $A(m-1, n-1)$ with $m \neq n$

The unitary superalgebra $A(m-1, n-1)$ or $sl(m|n)$ with $m \neq n$ defined for $m > n \geq 0$ has as even part the Lie algebra $sl(m) \oplus sl(n) \oplus U(1)$ and as odd part the $(\bar{m}, n) + (m, \bar{n})$ representation of the even part; it has rank $m+n-1$ and dimension $(m+n)^2-1$. One has $A(m-1, n-1) \simeq A(n-1, m-1)$.

The root system $\Delta = \Delta_{\bar{0}} \cup \Delta_{\bar{1}}$ of $A(m-1, n-1)$ can be expressed in terms of the orthogonal vectors $\varepsilon_1, \dots, \varepsilon_m$ and $\delta_1, \dots, \delta_n$ such that $\varepsilon_i^2 = 1$ and $\delta_i^2 = -1$ as

$$\Delta_{\bar{0}} = \{ \varepsilon_i - \varepsilon_j, \delta_i - \delta_j \} \quad \text{and} \quad \Delta_{\bar{1}} = \{ \varepsilon_i - \delta_j, -\varepsilon_i + \delta_j \}$$

The Dynkin diagrams of the unitary superalgebras $A(m-1, n-1)$ are of the following types:

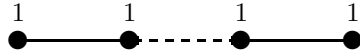

where the small black dots represent either white dots (associated to even roots) or grey dots (associated to odd roots of zero length). The diagrams are drawn with their Dynkin labels which give the decomposition of the highest root in terms of the simple ones. The Dynkin diagrams of the unitary Lie superalgebras up to rank 4 are given in Table 14.

The superalgebra $A(m-1, n-1)$ can be generated as a matrix superalgebra by taking matrices of the form

$$M = \begin{pmatrix} X_{mm} & T_{mn} \\ T_{nm} & X_{nn} \end{pmatrix}$$

where X_{mm} and X_{nn} are $gl(m)$ and $gl(n)$ matrices, T_{mn} and T_{nm} are $m \times n$ and $n \times m$ matrices respectively, with the supertrace condition

$$\text{str}(X) = \text{tr}(X_{mm}) - \text{tr}(X_{nn}) = 0$$

A basis of matrices can be constructed as follows. Consider $(m+n)^2$ elementary matrices e_{IJ} of order $m+n$ such that $(e_{IJ})_{KL} = \delta_{IL}\delta_{JK}$ ($I, J, K, L = 1, \dots, m+n$) and define the $(m+n)^2-1$ generators

$$\begin{aligned} E_{ij} &= e_{ij} - \frac{1}{m-n} \delta_{ij} (e_{kk} + e_{\bar{k}\bar{k}}) & E_{i\bar{j}} &= e_{i\bar{j}} \\ E_{\bar{i}\bar{j}} &= e_{\bar{i}\bar{j}} + \frac{1}{m-n} \delta_{\bar{i}\bar{j}} (e_{kk} + e_{\bar{k}\bar{k}}) & E_{\bar{i}j} &= e_{\bar{i}j} \end{aligned}$$

where the indices i, j, \dots run from 1 to m and \bar{i}, \bar{j}, \dots from $m+1$ to $m+n$. Then the generator $Z = E_{kk} - E_{\bar{k}\bar{k}} = -\frac{1}{m-n} (ne_{kk} + me_{\bar{k}\bar{k}})$ generate the $U(1)$ part, the generators

$E_{ij} - \frac{1}{m}\delta_{ij}Z$ generate the $sl(m)$ part and the generators $E_{\bar{i}\bar{j}} + \frac{1}{n}\delta_{\bar{i}\bar{j}}Z$ generate the $sl(n)$ part, while $E_{i\bar{j}}$ and $E_{\bar{i}j}$ transform as the (\bar{m}, n) and (m, \bar{n}) representations of $sl(m) \oplus sl(n) \oplus U(1)$. In all these expressions, summation over repeated indices is understood.

The generators in the Cartan-Weyl basis are given by:

- for the Cartan subalgebra

$$\begin{aligned} H_i &= E_{ii} - E_{i+1,i+1} \quad \text{with} \quad 1 \leq i \leq m-1 \\ H_{\bar{i}} &= E_{\bar{i}\bar{i}} - E_{\bar{i}+1,\bar{i}+1} \quad \text{with} \quad m+1 \leq \bar{i} \leq m+n-1 \\ H_m &= E_{mm} + E_{m+1,m+1} \end{aligned}$$

- for the raising operators

$$E_{ij} \text{ with } i < j \text{ for } sl(m), \quad E_{\bar{i}\bar{j}} \text{ with } \bar{i} < \bar{j} \text{ for } sl(n), \quad E_{i\bar{j}} \text{ for the odd part}$$

- for the lowering operators

$$E_{ji} \text{ with } i < j \text{ for } sl(m), \quad E_{\bar{j}\bar{i}} \text{ with } \bar{i} < \bar{j} \text{ for } sl(n), \quad E_{\bar{i}j} \text{ for the odd part}$$

The commutation relations in the Cartan-Weyl basis read as:

$$\begin{aligned} [H_I, H_J] &= 0 \\ [H_K, E_{IJ}] &= \delta_{IK}E_{KJ} - \delta_{I,K+1}E_{K+1,J} - \delta_{KJ}E_{IK} + \delta_{K+1,J}E_{I,K+1} \quad (K \neq m) \\ [H_m, E_{IJ}] &= \delta_{Im}E_{mJ} + \delta_{I,m+1}E_{m+1,J} - \delta_{mJ}E_{Im} - \delta_{m+1,J}E_{I,m+1} \\ [E_{IJ}, E_{KL}] &= \delta_{JK}E_{IL} - \delta_{IL}E_{KJ} \quad \text{for } E_{IJ} \text{ and } E_{KL} \text{ even} \\ [E_{IJ}, E_{KL}] &= \delta_{JK}E_{IL} - \delta_{IL}E_{KJ} \quad \text{for } E_{IJ} \text{ even and } E_{KL} \text{ odd} \\ \{E_{IJ}, E_{KL}\} &= \delta_{JK}E_{IL} + \delta_{IL}E_{KJ} \quad \text{for } E_{IJ} \text{ and } E_{KL} \text{ odd} \end{aligned}$$

The superalgebras $A(n-1, n-1)$ with $n > 1$

The unitary superalgebra $A(n-1, n-1)$ defined for $n > 1$ has as even part the Lie algebra $sl(n) \oplus sl(n)$ and as odd part the $(\bar{n}, n) + (n, \bar{n})$ representation of the even part; it has rank $2n-2$ and dimension $4n^2-2$. Note that the superalgebra $A(0, 0)$ is not simple.

The root system $\Delta = \Delta_{\bar{0}} \cup \Delta_{\bar{1}}$ of $A(n-1, n-1)$ can be expressed in terms of the orthogonal vectors $\varepsilon_1, \dots, \varepsilon_n$ and $\delta_1, \dots, \delta_n$ such that $\varepsilon_i^2 = 1$ and $\delta_i^2 = -1$ as

$$\Delta_{\bar{0}} = \{ \varepsilon_i - \varepsilon_j, \delta_i - \delta_j \} \quad \text{and} \quad \Delta_{\bar{1}} = \{ \varepsilon_i - \delta_j, -\varepsilon_i + \delta_j \}$$

The Dynkin diagrams of the unitary superalgebras $A(n-1, n-1)$ are of the same type as those of the $A(m-1, n-1)$ case.

The superalgebra $A(n-1, n-1)$ can be generated as a matrix superalgebra by taking matrices of $sl(n|n)$. However, $sl(n|n)$ contains a one-dimensional ideal \mathcal{I} generated by \mathbb{I}_{2n} and one sets $A(n-1, n-1) \equiv sl(n|n)/\mathcal{I}$, hence the rank and dimension of $A(n-1, n-1)$.

One has to stress that the rank of the superalgebra is $2n-2$ although the Dynkin diagram has $2n-1$ dots: the $2n-1$ associated simple roots are *not linearly independent* in that case.

Moreover, in the case of $A(1, 1)$, one has the relations $\varepsilon_1 + \varepsilon_2 = 0$ and $\delta_1 + \delta_2 = 0$ from which it follows that there is only four distinct odd roots α such that $\dim \mathcal{G}_\alpha = 2$ and each odd root is *both positive and negative*.

62 Universal enveloping algebra

Definition: Let $\mathcal{G} = \mathcal{G}_{\overline{0}} \oplus \mathcal{G}_{\overline{1}}$ be a Lie superalgebra over a field $\mathbb{K} = \mathbb{R}$ or \mathbb{C} . The definition of the universal enveloping superalgebra $\mathcal{U}(\mathcal{G})$ is similar to the definition in the algebraic case. If \mathcal{G}^{\otimes} is the tensor algebra over \mathcal{G} with \mathbb{Z}_2 -graded tensor product (\rightarrow Superalgebra) and \mathcal{I} the ideal of \mathcal{G} generated by $\llbracket X, Y \rrbracket - (X \otimes Y - (-1)^{\deg X \cdot \deg Y} Y \otimes X)$ where $X, Y \in \mathcal{G}$, the universal enveloping superalgebra $\mathcal{U}(\mathcal{G})$ is the quotient $\mathcal{G}^{\otimes}/\mathcal{I}$.

Poincaré–Birkhoff–Witt theorem: Let b_1, \dots, b_B ($B = \dim \mathcal{G}_{\overline{0}}$) be a basis of the even part $\mathcal{G}_{\overline{0}}$ and f_1, \dots, f_F ($F = \dim \mathcal{G}_{\overline{1}}$) be a basis of the odd part $\mathcal{G}_{\overline{1}}$. Then the elements

$$b_1^{i_1} \dots b_B^{i_B} f_1^{j_1} \dots f_F^{j_F} \quad \text{with} \quad i_1, \dots, i_B \geq 0 \text{ and } j_1, \dots, j_F \in \{0, 1\}$$

form a basis of the universal enveloping superalgebra $\mathcal{U}(\mathcal{G})$, called the Poincaré–Birkhoff–Witt (PBW) basis.

The universal enveloping superalgebra $\mathcal{U}(\mathcal{G})$ contains in general zero divisors (let us remind that $\mathcal{U}(\mathcal{G}_{\overline{0}})$ never contains zero divisors). In fact, if $F \in \mathcal{G}_{\overline{1}}$ is a generator associated to an isotropic root, one has $F^2 = \{F, F\} = 0$ in $\mathcal{U}(\mathcal{G})$. More precisely, one has the following property:

Property: The universal enveloping superalgebra $\mathcal{U}(\mathcal{G})$ does not contain any zero divisors if and only if $\mathcal{G} = ops(1|2n)$. In that case, $\mathcal{U}(\mathcal{G})$ is said entire.

Filtration of \mathcal{G} : $\mathcal{U}(\mathcal{G})$ can be naturally filtered as follows. Let \mathcal{U}_n be the subspace of $\mathcal{U}(\mathcal{G})$ generated by the PBW-basis monomials of degree $\leq n$ (e.g. $\mathcal{U}_0 = \mathbb{K}$ and $\mathcal{U}_1 = \mathbb{K} + \mathcal{G}$). Then one has the following filtration, with $\mathcal{U}_i \mathcal{U}_j \subset \mathcal{U}_{i+j}$:

$$\mathcal{U}_0 \subset \mathcal{U}_1 \subset \dots \subset \mathcal{U}_n \subset \dots \subset \mathcal{U}(\mathcal{G}) = \bigcup_{n=0}^{\infty} \mathcal{U}_n$$

Defining the quotient subspaces $\bar{\mathcal{U}}_0 = \mathcal{U}_0$ and $\bar{\mathcal{U}}_i = \mathcal{U}_i/\mathcal{U}_{i-1}$ for $i \geq 1$, one can associate to $\mathcal{U}(\mathcal{G})$ the following graded algebra $\text{Gr}(\mathcal{U}(\mathcal{G}))$:

$$\text{Gr}(\mathcal{U}(\mathcal{G})) = \bar{\mathcal{U}}_0 \oplus \bar{\mathcal{U}}_1 \oplus \dots \oplus \bar{\mathcal{U}}_n \oplus \dots$$

Then, one can show that

$$\text{Gr}(\mathcal{U}(\mathcal{G})) \simeq \mathbb{K}[b_1, \dots, b_B] \otimes \Lambda(f_1, \dots, f_F)$$

where $\mathbb{K}[b_1, \dots, b_B]$ is the ring of polynomials in the indeterminates b_1, \dots, b_B with coefficients in \mathbb{K} and $\Lambda(f_1, \dots, f_F)$ is the exterior algebra over \mathcal{G} .

For more details, see ref. [21].

63 Weyl group

Let $\mathcal{G} = \mathcal{G}_{\bar{0}} \oplus \mathcal{G}_{\bar{1}}$ be a classical Lie superalgebra with root system $\Delta = \Delta_{\bar{0}} \cup \Delta_{\bar{1}}$. $\Delta_{\bar{0}}$ is the set of even roots and $\Delta_{\bar{1}}$ the set of odd roots. The Weyl group $W(\mathcal{G})$ of \mathcal{G} is generated by the Weyl reflections ω with respect to the even roots:

$$\omega_{\alpha}(\beta) = \beta - 2 \frac{(\alpha, \beta)}{(\alpha, \alpha)} \alpha$$

where $\alpha \in \Delta_{\bar{0}}$ and $\beta \in \Delta$.

The properties of the Weyl group are the following.

Properties:

1. The Weyl group $W(\mathcal{G})$ leaves Δ , $\Delta_{\bar{0}}$, $\Delta_{\bar{1}}$, $\bar{\Delta}_{\bar{0}}$, $\bar{\Delta}_{\bar{1}}$ invariant, where Δ , $\Delta_{\bar{0}}$, $\Delta_{\bar{1}}$ are defined above, $\bar{\Delta}_{\bar{0}}$ is the subset of roots $\alpha \in \Delta_{\bar{0}}$ such that $\alpha/2 \notin \Delta_{\bar{1}}$ and $\bar{\Delta}_{\bar{1}}$ is the subset of roots $\alpha \in \Delta_{\bar{1}}$ such that $2\alpha \notin \Delta_{\bar{0}}$.
2. Let e^{λ} be the formal exponential, function on \mathcal{H}^* such that $e^{\lambda}(\mu) = \delta_{\lambda, \mu}$ for two elements $\lambda, \mu \in \mathcal{H}^*$, which satisfies $e^{\lambda}e^{\mu} = e^{\lambda+\mu}$. One defines

$$L = \frac{\prod_{\alpha \in \Delta_{\bar{0}}^+} (e^{\alpha/2} - e^{-\alpha/2})}{\prod_{\alpha \in \Delta_{\bar{1}}^+} (e^{\alpha/2} + e^{-\alpha/2})} \quad \text{and} \quad L' = \frac{\prod_{\alpha \in \Delta_{\bar{0}}^+} (e^{\alpha/2} - e^{-\alpha/2})}{\prod_{\alpha \in \Delta_{\bar{1}}^+} (e^{\alpha/2} - e^{-\alpha/2})}$$

where $\Delta_{\bar{0}}^+$ and $\Delta_{\bar{1}}^+$ are the sets of positive even roots and positive odd roots respectively. Then one has

$$w(L) = \varepsilon(w)L \quad \text{and} \quad w(L') = \varepsilon'(w)L' \quad \text{where} \quad w \in W(\mathcal{G})$$

with $\varepsilon(w) = (-1)^{\ell(w)}$ and $\varepsilon'(w) = (-1)^{\ell'(w)}$ where $\ell(w)$ is the number of reflections in the expression of $w \in W(\mathcal{G})$ and $\ell'(w)$ is the number of reflections with respect to the roots of $\bar{\Delta}_{\bar{0}}^+$ in the expression of $w \in W(\mathcal{G})$.

For more details, see ref. [21].

64 \mathbb{Z} -graded Lie superalgebras

Definition: Let $\mathcal{G} = \mathcal{G}_{\bar{0}} \oplus \mathcal{G}_{\bar{1}}$ be a Lie superalgebra. \mathcal{G} is a \mathbb{Z} -graded Lie superalgebra if it can be written as a direct sum of finite dimensional \mathbb{Z}_2 -graded subspaces \mathcal{G}_i such that

$$\mathcal{G} = \bigoplus_{i \in \mathbb{Z}} \mathcal{G}_i \quad \text{where} \quad \llbracket \mathcal{G}_i, \mathcal{G}_j \rrbracket \subset \mathcal{G}_{i+j}$$

The \mathbb{Z} -gradation is said *consistent* with the \mathbb{Z}_2 -gradation if

$$\mathcal{G}_{\bar{0}} = \sum_{i \in \mathbb{Z}} \mathcal{G}_{2i} \quad \text{and} \quad \mathcal{G}_{\bar{1}} = \sum_{i \in \mathbb{Z}} \mathcal{G}_{2i+1}$$

Definition: Let \mathcal{G} be a \mathbb{Z} -graded Lie superalgebra. It is called

- irreducible if the representation of $\mathcal{G}_{\bar{0}}$ in \mathcal{G}_{-1} is irreducible,
- transitive if $X \in \mathcal{G}_{i \geq 0}$, $\llbracket X, \mathcal{G}_{-1} \rrbracket = 0 \Rightarrow X = 0$,
- bitransitive if $X \in \mathcal{G}_{i \geq 0}$, $\llbracket X, \mathcal{G}_{-1} \rrbracket = 0 \Rightarrow X = 0$ and $X \in \mathcal{G}_{i \leq 0}$, $\llbracket X, \mathcal{G}_1 \rrbracket = 0 \Rightarrow X = 0$.

For more details, see ref. [21].

List of Tables

| | | |
|----|---|-----|
| 1 | Classification of the simple Lie superalgebras. | 98 |
| 2 | Classical Lie superalgebras. | 98 |
| 3 | $\mathcal{G}_{\overline{0}}$ and $\mathcal{G}_{\overline{1}}$ structure of the classical Lie superalgebras. | 98 |
| 4 | The basic Lie superalgebra $A(m-1, n-1) = sl(m n)$ | 99 |
| 5 | The basic Lie superalgebra $A(n-1, n-1) = sl(n n)/\mathcal{Z}$ | 101 |
| 6 | The basic Lie superalgebra $B(m, n) = osp(2m+1 2n)$ | 103 |
| 7 | The basic Lie superalgebra $B(0, n) = osp(1 2n)$ | 105 |
| 8 | The basic Lie superalgebra $C(n+1) = osp(2 2n)$ | 107 |
| 9 | The basic Lie superalgebra $D(m, n) = osp(2m 2n)$ | 109 |
| 10 | The basic Lie superalgebra $F(4)$ | 111 |
| 11 | The basic Lie superalgebra $G(3)$ | 113 |
| 12 | The basic Lie superalgebra $D(2, 1; \alpha)$ | 114 |
| 13 | Distinguished Dynkin diagrams of the basic Lie superalgebras. | 116 |
| 14 | Dynkin diagrams of the basic Lie superalgebras of rank ≤ 4 | 117 |
| 15 | Distinguished extended Dynkin diagrams of the basic Lie superalgebras. . . | 120 |
| 16 | Real forms of the classical Lie superalgebras. | 121 |
| 17 | $osp(1 2)$ decompositions of the fundamental representations of the basic Lie superalgebras (regular cases). | 122 |
| 18 | $osp(1 2)$ decompositions of the fundamental representations of the basic Lie superalgebras (singular cases). | 123 |
| 19 | $osp(1 2)$ decompositions of the adjoint representations of the basic Lie superalgebras (regular cases). | 124 |
| 20 | $osp(1 2)$ decompositions of the adjoint representations of the basic Lie superalgebras (singular cases). | 126 |
| 21 | $osp(1 2)$ decompositions of the $A(m, n)$ superalgebras up to rank 4. | 127 |
| 22 | $osp(1 2)$ decompositions of the $B(m, n)$ superalgebras of rank 2 and 3. . . | 127 |
| 23 | $osp(1 2)$ decompositions of the $B(m, n)$ superalgebras of rank 4. | 128 |
| 24 | $osp(1 2)$ decompositions of the $C(n+1)$ superalgebras up to rank 4. . . . | 129 |
| 25 | $osp(1 2)$ decompositions of the $D(m, n)$ superalgebras up to rank 4. . . . | 129 |
| 26 | $osp(1 2)$ decompositions of the superalgebra $F(4)$ | 130 |
| 27 | $osp(1 2)$ decompositions of the superalgebra $G(3)$ | 130 |
| 28 | $osp(1 2)$ decompositions of the superalgebra $D(2, 1; \alpha)$ | 130 |
| 29 | $sl(1 2)$ decompositions of the $A(m, n)$ superalgebras up to rank 4. | 131 |
| 30 | $sl(1 2)$ decompositions of the $B(m, n)$ superalgebras of rank 2 and 3. . . . | 131 |
| 31 | $sl(1 2)$ decompositions of the $B(m, n)$ superalgebras of rank 4. | 132 |

| | | |
|----|---|-----|
| 32 | $sl(1 2)$ decompositions of the $C(n+1)$ superalgebras up to rank 4. | 133 |
| 33 | $sl(1 2)$ decompositions of the $D(m, n)$ superalgebras up to rank 4. | 133 |
| 34 | $sl(1 2)$ decompositions of the exceptional superalgebras. | 134 |

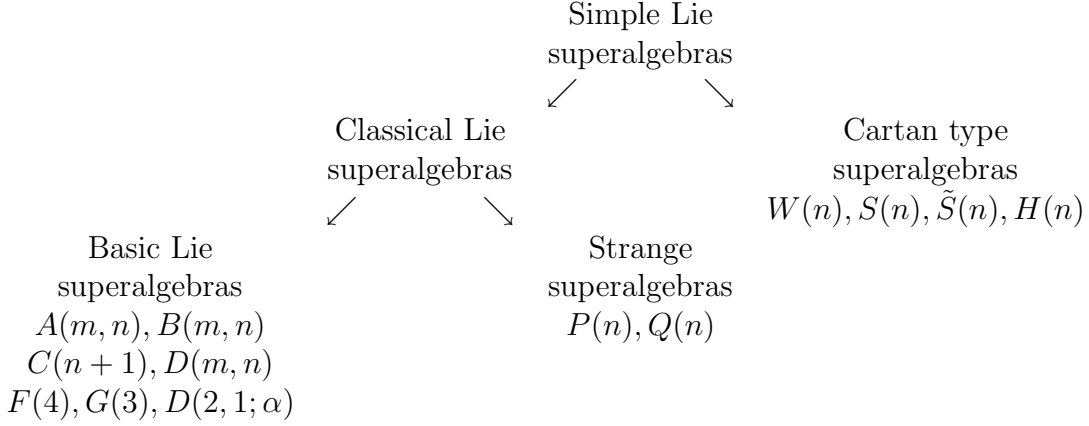

Table 1: Classification of the simple Lie superalgebras.

| | type I | type II |
|---|---|--|
| BASIC (non-degenerate Killing form) | $A(m, n) \quad m > n \geq 0$ $C(n+1) \quad n \geq 1$ $F(4)$ $G(3)$ | $B(m, n) \quad m \geq 0, n \geq 1$ $D(m, n) \quad \begin{cases} m \geq 2, n \geq 1 \\ m \neq n+1 \end{cases}$ |
| BASIC (zero Killing form) | $A(n, n) \quad n \geq 1$ | $D(n+1, n) \quad n \geq 1$ $D(2, 1; \alpha) \quad \alpha \in \mathbb{C} \setminus \{0, -1\}$ |
| STRANGE | $P(n) \quad n \geq 2$ | $Q(n) \quad n \geq 2$ |

Table 2: Classical Lie superalgebras.

| superalgebra \mathcal{G} | even part $\mathcal{G}_{\bar{0}}$ | odd part $\mathcal{G}_{\bar{1}}$ |
|----------------------------|-----------------------------------|------------------------------------|
| $A(m, n)$ | $A_m \oplus A_n \oplus U(1)$ | $(\bar{m}, n) \oplus (m, \bar{n})$ |
| $A(n, n)$ | $A_n \oplus A_n$ | $(\bar{n}, n) \oplus (n, \bar{n})$ |
| $C(n+1)$ | $C_n \oplus U(1)$ | $(2n) \oplus (2n)$ |
| $B(m, n)$ | $B_m \oplus C_n$ | $(2m+1, 2n)$ |
| $D(m, n)$ | $D_m \oplus C_n$ | $(2m, 2n)$ |
| $F(4)$ | $A_1 \oplus B_3$ | $(2, 8)$ |
| $G(3)$ | $A_1 \oplus G_2$ | $(2, 7)$ |
| $D(2, 1; \alpha)$ | $A_1 \oplus A_1 \oplus A_1$ | $(2, 2, 2)$ |
| $P(n)$ | A_n | $[2] \oplus [1^{n-1}]$ |
| $Q(n)$ | A_n | $\text{ad}(A_n)$ |

Table 3: $\mathcal{G}_{\bar{0}}$ and $\mathcal{G}_{\bar{1}}$ structure of the classical Lie superalgebras.

Table 4: The basic Lie superalgebra $A(m-1, n-1) = sl(m|n)$.

Structure: $\mathcal{G}_{\bar{0}} = sl(m) \oplus sl(n) \oplus U(1)$ and $\mathcal{G}_{\bar{1}} = (\bar{m}, n) \oplus (m, \bar{n})$, type I.

Rank: $m+n-1$, dimension: $(m+n)^2 - 1$.

Root system:

$$\begin{aligned}\Delta &= \{\varepsilon_i - \varepsilon_j, \delta_k - \delta_l, \varepsilon_i - \delta_k, \delta_k - \varepsilon_i\} \\ \Delta_{\bar{0}} &= \{\varepsilon_i - \varepsilon_j, \delta_k - \delta_l\}, \quad \Delta_{\bar{1}} = \{\varepsilon_i - \delta_k, \delta_k - \varepsilon_i\} \\ \bar{\Delta}_{\bar{0}} &= \Delta_{\bar{0}}, \quad \bar{\Delta}_{\bar{1}} = \Delta_{\bar{1}}\end{aligned}$$

where $1 \leq i \neq j \leq m$ and $1 \leq k \neq l \leq n$.

$\dim \Delta_{\bar{0}} = \dim \bar{\Delta}_{\bar{0}} = m^2 + n^2 - m - n + 1$ and $\dim \Delta_{\bar{1}} = \dim \bar{\Delta}_{\bar{1}} = 2mn$.

Distinguished simple root system:

$$\begin{aligned}\alpha_1 &= \delta_1 - \delta_2, \dots, \alpha_{n-1} = \delta_{n-1} - \delta_n, \alpha_n = \delta_n - \varepsilon_1, \\ \alpha_{n+1} &= \varepsilon_1 - \varepsilon_2, \dots, \alpha_{n+m-1} = \varepsilon_{m-1} - \varepsilon_m\end{aligned}$$

Distinguished positive roots ($1 \leq i < j \leq m$ and $1 \leq k < l \leq n$):

$$\begin{aligned}\delta_k - \delta_l &= \alpha_k + \dots + \alpha_{l-1} \\ \varepsilon_i - \varepsilon_j &= \alpha_{n+i} + \dots + \alpha_{n+j-1} \\ \delta_k - \varepsilon_i &= \alpha_k + \dots + \alpha_{n+i-1}\end{aligned}$$

Sums of even/odd distinguished positive roots:

$$\begin{aligned}2\rho_0 &= (m-1)\varepsilon_1 + (m-3)\varepsilon_2 + (m-5)\varepsilon_3 + \dots - (m-3)\varepsilon_{m-1} - (m-1)\varepsilon_m \\ &\quad + (n-1)\delta_1 + (n-3)\delta_2 + (n-5)\delta_3 + \dots - (n-3)\delta_{n-1} - (n-1)\delta_n \\ 2\rho_1 &= m(\delta_1 + \dots + \delta_n) - n(\varepsilon_1 + \dots + \varepsilon_m)\end{aligned}$$

Distinguished Dynkin diagram:

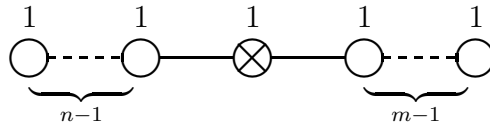

Distinguished Cartan matrix:

$$\left(\begin{array}{cccc|c|cccc|c} 2 & -1 & 0 & \cdots & 0 & \cdots & \cdots & \cdots & 0 & \vdots \\ -1 & \ddots & \ddots & \ddots & & & & & & \vdots \\ 0 & \ddots & & \ddots & 0 & & & & & \vdots \\ \vdots & \ddots & \ddots & \ddots & -1 & \ddots & & & & \vdots \\ 0 & & 0 & -1 & 2 & -1 & \ddots & & & \vdots \\ \hline \vdots & & \ddots & -1 & 0 & 1 & \ddots & & & \vdots \\ \hline \vdots & & & \ddots & -1 & 2 & -1 & 0 & 0 & \vdots \\ & & & & \ddots & -1 & \ddots & \ddots & \ddots & \vdots \\ & & & & & 0 & \ddots & & \ddots & 0 \\ & & & & & & \ddots & \ddots & \ddots & -1 \\ 0 & \cdots & & \cdots & \cdots & 0 & \cdots & 0 & -1 & 2 \end{array} \right)$$

Longest distinguished root:

$$-\alpha_0 = \alpha_1 + \dots + \alpha_{n+m-1} = \delta_1 - \varepsilon_m$$

Distinguished extended Dynkin diagram:

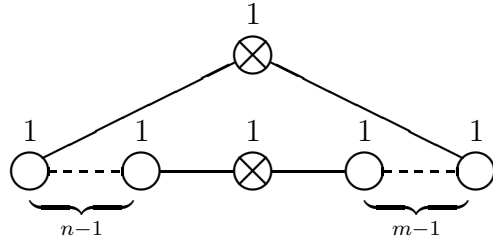

Factor group $\text{Out}(\mathcal{G}) = \text{Aut}(\mathcal{G})/\text{Int}(\mathcal{G})$:

$$\text{Out}(\mathcal{G}) = \mathbb{Z}_2 \text{ for } A(m, n) \text{ with } m \neq n \neq 0 \text{ and } A(0, 2n - 1)$$

$$\text{Out}(\mathcal{G}) = \mathbb{Z}_4 \text{ for } A(0, 2n)$$

Table 5: The basic Lie superalgebra $A(n-1, n-1) = sl(n|n)/\mathcal{Z}$.

Structure: $\mathcal{G}_{\bar{0}} = sl(n) \oplus sl(n)$ and $\mathcal{G}_{\bar{1}} = (\bar{n}, n) \oplus (n, \bar{n})$, type I.

Rank: $2n - 2$, dimension: $4n^2 - 2$.

Root system:

$$\begin{aligned}\Delta &= \{\varepsilon_i - \varepsilon_j, \delta_i - \delta_j, \varepsilon_i - \delta_j, \delta_j - \varepsilon_i\} \\ \Delta_{\bar{0}} &= \{\varepsilon_i - \varepsilon_j, \delta_i - \delta_j\}, \quad \Delta_{\bar{1}} = \{\varepsilon_i - \delta_j, \delta_j - \varepsilon_i\} \\ \overline{\Delta}_{\bar{0}} &= \Delta_{\bar{0}}, \quad \overline{\Delta}_{\bar{1}} = \Delta_{\bar{1}}\end{aligned}$$

where $1 \leq i \neq j \leq n$.

$\dim \Delta_{\bar{0}} = \dim \overline{\Delta}_{\bar{0}} = 2n^2 - 2n$ and $\dim \Delta_{\bar{1}} = \dim \overline{\Delta}_{\bar{1}} = 2n^2$.

Distinguished simple root system:

$$\begin{aligned}\alpha_1 &= \delta_1 - \delta_2, \dots, \alpha_{n-1} = \delta_{n-1} - \delta_n, \alpha_n = \delta_n - \varepsilon_1, \\ \alpha_{n+1} &= \varepsilon_1 - \varepsilon_2, \dots, \alpha_{2n-1} = \varepsilon_{n-1} - \varepsilon_n\end{aligned}$$

Number of simple roots = $2n - 1$ (\neq rank); the simple roots are not independent:

$$\alpha_1 + 2\alpha_2 + \dots + n\alpha_n + (n-1)\alpha_{n+1} + \dots + 2\alpha_{2n-2} + \alpha_{2n-1} = 0$$

Distinguished positive roots ($1 \leq i < j \leq m$ and $1 \leq k < l \leq n$):

$$\begin{aligned}\delta_k - \delta_l &= \alpha_k + \dots + \alpha_{l-1} \\ \varepsilon_i - \varepsilon_j &= \alpha_{n+i} + \dots + \alpha_{n+j-1} \\ \delta_k - \varepsilon_i &= \alpha_k + \dots + \alpha_{n+i-1}\end{aligned}$$

Sums of even/odd distinguished positive roots:

$$\begin{aligned}2\rho_0 &= (n-1)\varepsilon_1 + (n-3)\varepsilon_2 + (n-5)\varepsilon_3 + \dots - (n-3)\varepsilon_{n-1} - (n-1)\varepsilon_n \\ &\quad + (n-1)\delta_1 + (n-3)\delta_2 + (n-5)\delta_3 + \dots - (n-3)\delta_{n-1} - (n-1)\delta_n \\ 2\rho_1 &= n(\delta_1 + \dots + \delta_n - \varepsilon_1 - \dots - \varepsilon_n)\end{aligned}$$

Distinguished Dynkin diagram:

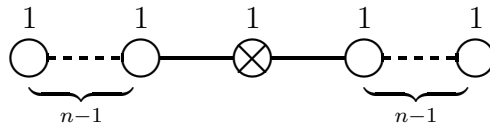

Distinguished Cartan matrix:

$$\left(\begin{array}{cccc|cccc|cccc|cccc} 2 & -1 & 0 & \cdots & 0 & \cdots & \cdots & \cdots & \cdots & \cdots & 0 & \cdots & \cdots & \cdots & \cdots & 0 \\ -1 & \ddots & \ddots & \ddots & \ddots & \cdots & \cdots & \cdots & \cdots & \cdots & \vdots & \cdots & \cdots & \cdots & \cdots & \vdots \\ 0 & \ddots & & & \ddots & 0 & \cdots & \cdots & \cdots & \cdots & \vdots & \cdots & \cdots & \cdots & \cdots & \vdots \\ \vdots & \ddots & \ddots & \ddots & \ddots & -1 & \ddots & \cdots & \cdots & \cdots & \vdots & \cdots & \cdots & \cdots & \cdots & \vdots \\ 0 & & & 0 & -1 & 2 & -1 & \ddots & \cdots & \cdots & \vdots & \cdots & \cdots & \cdots & \cdots & \vdots \\ \hline \vdots & & & \ddots & -1 & 0 & 1 & \ddots & \cdots & \cdots & \vdots & \cdots & \cdots & \cdots & \cdots & \vdots \\ \hline \vdots & & & & \ddots & -1 & 2 & -1 & 0 & \cdots & 0 & \cdots & \cdots & \cdots & \cdots & \vdots \\ & & & & & \ddots & -1 & \ddots & \ddots & \ddots & \vdots & \cdots & \cdots & \cdots & \cdots & \vdots \\ & & & & & & 0 & \ddots & & \ddots & 0 & \cdots & \cdots & \cdots & \cdots & \vdots \\ & & & & & & & \ddots & \ddots & \ddots & -1 & \cdots & \cdots & \cdots & \cdots & \vdots \\ 0 & \cdots & & & \cdots & \cdots & \cdots & 0 & \cdots & 0 & -1 & 2 & \cdots & \cdots & \cdots & \vdots \end{array} \right)$$

Longest distinguished root:

$$-\alpha_0 = \alpha_1 + \dots + \alpha_{2n-1} = \delta_1 - \varepsilon_n$$

Distinguished extended Dynkin diagram:

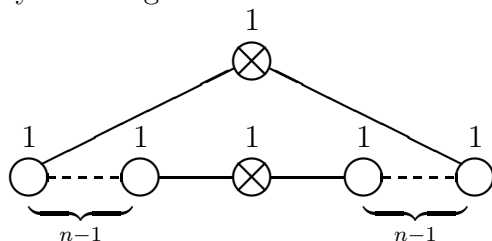

Factor group $\text{Out}(\mathcal{G}) = \text{Aut}(\mathcal{G})/\text{Int}(\mathcal{G})$:

$$\text{Out}(\mathcal{G}) = \mathbb{Z}_2 \times \mathbb{Z}_2 \text{ for } A(n, n) \text{ with } n \neq 1$$

$$\text{Out}(\mathcal{G}) = \mathbb{Z}_2 \text{ for } A(1, 1)$$

Table 6: The basic Lie superalgebra $B(m, n) = osp(2m + 1|2n)$.

Structure: $\mathcal{G}_{\bar{0}} = so(2m + 1) \oplus sp(2n)$ and $\mathcal{G}_{\bar{1}} = (2m + 1, 2n)$, type II.

Rank: $m + n$, dimension: $2(m + n)^2 + m + 3n$.

Root system:

$$\begin{aligned}\Delta &= \{\pm\varepsilon_i \pm \varepsilon_j, \pm\varepsilon_i, \pm\delta_k \pm \delta_l, \pm 2\delta_k, \pm\varepsilon_i \pm \delta_k, \pm\delta_k\} \\ \Delta_{\bar{0}} &= \{\pm\varepsilon_i \pm \varepsilon_j, \pm\varepsilon_i, \pm\delta_k \pm \delta_l, \pm 2\delta_k\}, \quad \Delta_{\bar{1}} = \{\pm\varepsilon_i \pm \delta_k, \pm\delta_k\} \\ \overline{\Delta}_{\bar{0}} &= \{\pm\varepsilon_i \pm \varepsilon_j, \pm\varepsilon_i, \pm\delta_k \pm \delta_l\}, \quad \overline{\Delta}_{\bar{1}} = \{\pm\varepsilon_i \pm \delta_k\}\end{aligned}$$

where $1 \leq i \neq j \leq m$ and $1 \leq k \neq l \leq n$.

$\dim \Delta_{\bar{0}} = 2m^2 + 2n^2$, $\dim \Delta_{\bar{1}} = 4mn + 2n$, $\dim \overline{\Delta}_{\bar{0}} = 2m^2 + 2n^2 - 2n$, $\dim \overline{\Delta}_{\bar{1}} = 4mn$.

Distinguished simple root system:

$$\begin{aligned}\alpha_1 &= \delta_1 - \delta_2, \dots, \alpha_{n-1} = \delta_{n-1} - \delta_n, \alpha_n = \delta_n - \varepsilon_1, \\ \alpha_{n+1} &= \varepsilon_1 - \varepsilon_2, \dots, \alpha_{n+m-1} = \varepsilon_{m-1} - \varepsilon_m, \alpha_{n+m} = \varepsilon_m\end{aligned}$$

Distinguished positive roots ($1 \leq i < j \leq m$ and $1 \leq k < l \leq n$):

$$\begin{aligned}\delta_k - \delta_l &= \alpha_k + \dots + \alpha_{l-1} \\ \delta_k + \delta_l &= \alpha_k + \dots + \alpha_{l-1} + 2\alpha_l + \dots + 2\alpha_{n+m} \\ 2\delta_k &= 2\alpha_k + \dots + 2\alpha_{n+m} \\ \varepsilon_i - \varepsilon_j &= \alpha_{n+i} + \dots + \alpha_{n+j-1} \\ \varepsilon_i + \varepsilon_j &= \alpha_{n+i} + \dots + \alpha_{n+j-1} + 2\alpha_{n+j} + \dots + 2\alpha_{n+m} \\ \varepsilon_i &= \alpha_{n+i} + \dots + \alpha_{n+m} \\ \delta_k - \varepsilon_i &= \alpha_k + \dots + \alpha_{n+i-1} \\ \delta_k + \varepsilon_i &= \alpha_k + \dots + \alpha_{n+i-1} + 2\alpha_{n+i} + \dots + 2\alpha_{n+m}\end{aligned}$$

Sums of even/odd distinguished positive roots:

$$\begin{aligned}2\rho_0 &= (2m - 1)\varepsilon_1 + (2m - 3)\varepsilon_2 + \dots + 3\varepsilon_{m-1} + \varepsilon_m \\ &\quad + 2n\delta_1 + (2n - 2)\delta_2 + \dots + 4\delta_{n-1} + 2\delta_n \\ 2\rho_1 &= (2m + 1)(\delta_1 + \dots + \delta_n)\end{aligned}$$

Distinguished Dynkin diagram:

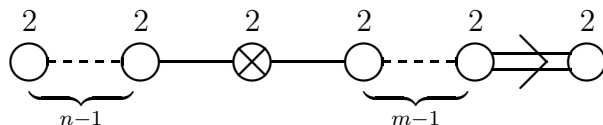

Distinguished Cartan matrix:

$$\left(\begin{array}{cccc|cccc|cccc|cccc} 2 & -1 & 0 & \cdots & 0 & \cdots & \cdots & & \cdots & & \cdots & & 0 \\ -1 & \ddots & \ddots & \ddots & & & & & & & & & \vdots \\ 0 & \ddots & & \ddots & 0 & & & & & & & & \\ \vdots & \ddots & \ddots & \ddots & -1 & \ddots & & & & & & & \\ 0 & & 0 & -1 & 2 & -1 & \ddots & & & & & & \vdots \\ \hline \vdots & & & \ddots & -1 & 0 & 1 & \ddots & & & & & \vdots \\ \hline \vdots & & & & \ddots & -1 & 2 & -1 & 0 & & & & 0 \\ & & & & & \ddots & -1 & \ddots & \ddots & \ddots & & & \vdots \\ & & & & & & 0 & \ddots & \ddots & -1 & 0 & & \\ & & & & & & & \ddots & -1 & 2 & -1 & & \\ 0 & \cdots & & & \cdots & \cdots & 0 & \cdots & 0 & -2 & 2 & & \end{array} \right)$$

Longest distinguished root:

$$-\alpha_0 = 2\alpha_1 + \dots + 2\alpha_{n+m} = 2\delta_1$$

Distinguished extended Dynkin diagram:

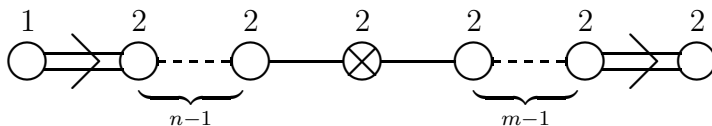

Factor group $\text{Out}(\mathcal{G}) = \text{Aut}(\mathcal{G})/\text{Int}(\mathcal{G}) = \mathbb{I}$.

Table 7: The basic Lie superalgebra $B(0, n) = osp(1|2n)$.

Structure: $\mathcal{G}_{\bar{0}} = sp(2n)$ and $\mathcal{G}_{\bar{1}} = (2n)$, type II.

Rank: n , dimension: $2n^2 + 3n$.

Root system:

$$\begin{aligned}\Delta &= \{\pm\delta_k \pm \delta_l, \pm 2\delta_k, \pm\delta_k\} \\ \Delta_{\bar{0}} &= \{\pm\delta_k \pm \delta_l, \pm 2\delta_k\}, \quad \Delta_{\bar{1}} = \{\pm\delta_k\} \\ \bar{\Delta}_{\bar{0}} &= \{\pm\delta_k \pm \delta_l\}, \quad \bar{\Delta}_{\bar{1}} = \emptyset\end{aligned}$$

where $1 \leq k \neq l \leq n$.

$\dim \Delta_{\bar{0}} = 2n^2$, $\dim \Delta_{\bar{1}} = 2n$, $\dim \bar{\Delta}_{\bar{0}} = 2n^2 - 2n$, $\dim \bar{\Delta}_{\bar{1}} = 0$.

Simple root system:

$$\alpha_1 = \delta_1 - \delta_2, \dots, \alpha_{n-1} = \delta_{n-1} - \delta_n, \alpha_n = \delta_n$$

Positive roots ($1 \leq k < l \leq n$):

$$\begin{aligned}\delta_k - \delta_l &= \alpha_k + \dots + \alpha_{l-1} \\ \delta_k + \delta_l &= \alpha_k + \dots + \alpha_{l-1} + 2\alpha_l + \dots + 2\alpha_{n+m} \\ 2\delta_k &= 2\alpha_k + \dots + 2\alpha_{n+m} \\ \delta_k &= \alpha_k + \dots + \alpha_{n+m}\end{aligned}$$

Sums of even/odd positive roots:

$$\begin{aligned}2\rho_0 &= 2n\delta_1 + (2n-2)\delta_2 + \dots + 4\delta_{n-1} + 2\delta_n \\ 2\rho_1 &= \delta_1 + \dots + \delta_n\end{aligned}$$

Dynkin diagram:

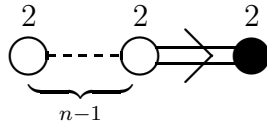

Cartan matrix:

$$\begin{pmatrix} 2 & -1 & 0 & \cdots & \cdots & 0 \\ -1 & 2 & \ddots & \ddots & & \vdots \\ 0 & \ddots & \ddots & \ddots & \ddots & \vdots \\ \vdots & \ddots & \ddots & 2 & -1 & 0 \\ \vdots & & \ddots & -1 & 2 & -1 \\ 0 & \cdots & \cdots & 0 & -2 & 2 \end{pmatrix}$$

Longest distinguished root:

$$-\alpha_0 = 2\alpha_1 + \dots + 2\alpha_n = 2\delta_1$$

Extended Dynkin diagram:

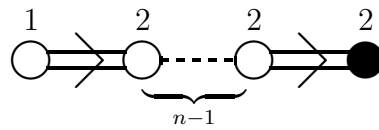

Factor group $\text{Out}(\mathcal{G}) = \text{Aut}(\mathcal{G})/\text{Int}(\mathcal{G}) = \mathbb{I}$.

Table 8: The basic Lie superalgebra $C(n+1) = osp(2|2n)$.

Structure: $\mathcal{G}_{\bar{0}} = so(2) \oplus sp(2n)$ and $\mathcal{G}_{\bar{1}} = (2n) \oplus (2n)$, type I.

Rank: $n+1$, dimension: $2n^2 + 5n + 1$.

Root system:

$$\begin{aligned}\Delta &= \{\pm\delta_k \pm \delta_l, \pm 2\delta_k, \pm\varepsilon \pm \delta_k\} \\ \Delta_{\bar{0}} &= \{\pm\delta_k \pm \delta_l, \pm 2\delta_k\}, \quad \Delta_{\bar{1}} = \{\pm\varepsilon \pm \delta_k\} \\ \bar{\Delta}_{\bar{0}} &= \Delta_{\bar{0}}, \quad \bar{\Delta}_{\bar{1}} = \Delta_{\bar{1}}\end{aligned}$$

where $1 \leq k \neq l \leq n$.

$\dim \Delta_{\bar{0}} = \dim \bar{\Delta}_{\bar{0}} = 2n^2$ and $\dim \Delta_{\bar{1}} = \dim \bar{\Delta}_{\bar{1}} = 4n$.

Distinguished simple root system:

$$\alpha_1 = \varepsilon - \delta_1, \alpha_2 = \delta_1 - \delta_2, \dots, \alpha_n = \delta_{n-1} - \delta_n, \alpha_{n+1} = 2\delta_n$$

Distinguished positive roots ($1 \leq k < l \leq n$):

$$\begin{aligned}\delta_k - \delta_l &= \alpha_{k+1} + \dots + \alpha_l \\ \delta_k + \delta_l &= \alpha_{k+1} + \dots + \alpha_l + 2\alpha_{l+1} + \dots + 2\alpha_{n+1} \\ 2\delta_k &= 2\alpha_{k+1} + \dots + 2\alpha_n + \alpha_{n+1} \quad (k \neq n) \quad 2\delta_n = \alpha_{n+1} \\ \varepsilon - \delta_k &= \alpha_1 + \dots + \alpha_k \\ \varepsilon + \delta_k &= \alpha_1 + \dots + \alpha_k + 2\alpha_{k+1} + \dots + 2\alpha_n + \alpha_{n+1} \quad (k < n) \\ \varepsilon + \delta_n &= \alpha_1 + \dots + \alpha_{n+1}\end{aligned}$$

Sums of even/odd distinguished positive roots:

$$\begin{aligned}2\rho_0 &= 2n\delta_1 + (2n-2)\delta_2 + \dots + 4\delta_{n-1} + 2\delta_n \\ 2\rho_1 &= 2n\varepsilon\end{aligned}$$

Distinguished Dynkin diagram:

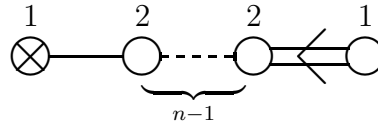

Distinguished Cartan matrix:

$$\left(\begin{array}{c|cccccc} 0 & 1 & 0 & \cdots & \cdots & 0 \\ -1 & 2 & -1 & 0 & & 0 \\ 0 & -1 & \ddots & \ddots & \ddots & \vdots \\ 0 & 0 & \ddots & \ddots & -1 & 0 \\ \vdots & & \ddots & -1 & 2 & -2 \\ 0 & \cdots & \cdots & 0 & -1 & 2 \end{array} \right)$$

Longest distinguished root:

$$-\alpha_0 = \alpha_1 + 2\alpha_2 + \dots + 2\alpha_{n+1} + \alpha_n = \varepsilon + \delta_1$$

Distinguished extended Dynkin diagram:

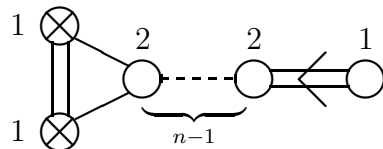

Factor group $\text{Out}(\mathcal{G}) = \text{Aut}(\mathcal{G})/\text{Int}(\mathcal{G}) = \mathbb{Z}_2$.

Table 9: The basic Lie superalgebra $D(m, n) = osp(2m|2n)$.

Structure: $\mathcal{G}_{\bar{0}} = so(2m) \oplus sp(2n)$ and $\mathcal{G}_{\bar{1}} = (2m, 2n)$, type II.

Rank: $m + n$, dimension: $2(m + n)^2 - m + n$.

Root system:

$$\begin{aligned}\Delta &= \{\pm\varepsilon_i \pm \varepsilon_j, \pm\delta_k \pm \delta_l, \pm 2\delta_k, \pm\varepsilon_i \pm \delta_k\} \\ \Delta_{\bar{0}} &= \{\pm\varepsilon_i \pm \varepsilon_j, \pm\delta_k \pm \delta_l, \pm 2\delta_k\}, \quad \Delta_{\bar{1}} = \{\pm\varepsilon_i \pm \delta_k\} \\ \overline{\Delta}_{\bar{0}} &= \Delta_{\bar{0}}, \quad \overline{\Delta}_{\bar{1}} = \Delta_{\bar{1}}\end{aligned}$$

where $1 \leq i \neq j \leq m$ and $1 \leq k \neq l \leq n$.

$\dim \Delta_{\bar{0}} = \dim \overline{\Delta}_{\bar{0}} = 2m^2 + 2n^2 - 2m$ and $\dim \Delta_{\bar{1}} = \dim \overline{\Delta}_{\bar{1}} = 4mn$.

Distinguished simple root system:

$$\begin{aligned}\alpha_1 &= \delta_1 - \delta_2, \dots, \alpha_{n-1} = \delta_{n-1} - \delta_n, \alpha_n = \delta_n - \varepsilon_1, \\ \alpha_{n+1} &= \varepsilon_1 - \varepsilon_2, \dots, \alpha_{n+m-1} = \varepsilon_{m-1} - \varepsilon_m, \alpha_{n+m} = \varepsilon_{m-1} + \varepsilon_m\end{aligned}$$

Distinguished positive roots ($1 \leq i < j \leq m$ and $1 \leq k < l \leq n$):

$$\begin{aligned}\delta_k - \delta_l &= \alpha_k + \dots + \alpha_{l-1} \\ \delta_k + \delta_l &= \alpha_k + \dots + \alpha_{l-1} + 2\alpha_l + \dots + 2\alpha_{n+m-2} + \alpha_{n+m-1} + \alpha_{n+m} \\ 2\delta_k &= 2\alpha_k + \dots + 2\alpha_{n+m-2} + \alpha_{n+m-1} + \alpha_{n+m} \\ \varepsilon_i - \varepsilon_j &= \alpha_{n+i} + \dots + \alpha_{n+j-1} \\ \varepsilon_i + \varepsilon_j &= \alpha_{n+i} + \dots + \alpha_{n+j-1} + 2\alpha_{n+j} + \dots + 2\alpha_{n+m-2} + \alpha_{n+m-1} + \alpha_{n+m} \quad (j < m - 1) \\ \varepsilon_i + \varepsilon_{m-1} &= \alpha_{n+i} + \dots + \alpha_{n+m-2} + \alpha_{n+m-1} + \alpha_{n+m} \\ \varepsilon_i + \varepsilon_m &= \alpha_{n+i} + \dots + \alpha_{n+m-2} + \alpha_{n+m} \\ \delta_k - \varepsilon_i &= \alpha_k + \dots + \alpha_{n+i-1} \\ \delta_k + \varepsilon_i &= \alpha_k + \dots + \alpha_{n+i-1} + 2\alpha_{n+i} + \dots + 2\alpha_{n+m-2} + \alpha_{n+m-1} + \alpha_{n+m} \quad (j < m - 1) \\ \delta_k + \varepsilon_{m-1} &= \alpha_k + \dots + \alpha_{n+m-2} + \alpha_{n+m-1} + \alpha_{n+m} \\ \delta_k + \varepsilon_m &= \alpha_k + \dots + \alpha_{n+m-2} + \alpha_{n+m}\end{aligned}$$

Sums of even/odd distinguished positive roots:

$$\begin{aligned}2\rho_0 &= (2m - 2)\varepsilon_1 + (2m - 4)\varepsilon_2 + \dots + 2\varepsilon_{m-1} + 2n\delta_1 + (2n - 2)\delta_2 + \dots + 4\delta_{n-1} + 2\delta_n \\ 2\rho_1 &= 2m(\delta_1 + \dots + \delta_n)\end{aligned}$$

Distinguished Dynkin diagram:

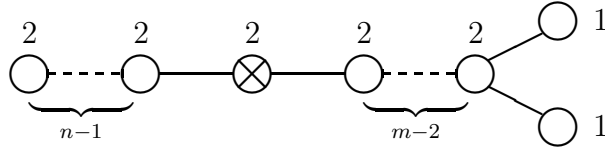

Distinguished Cartan matrix:

$$\left(\begin{array}{cccc|cccc|cccc|cccc} 2 & -1 & 0 & \cdots & 0 & \cdots & \cdots & & & \cdots & & & & & 0 \\ -1 & \ddots & \ddots & \ddots & \ddots & & & & & & & & & & \vdots \\ 0 & \ddots & & \ddots & 0 & & & & & & & & & & \\ \vdots & \ddots & \ddots & \ddots & -1 & \ddots & & & & & & & & & \\ 0 & & 0 & -1 & 2 & -1 & \ddots & & & & & & & & \vdots \\ \hline \vdots & & & \ddots & -1 & 0 & 1 & \ddots & & & & & & & \vdots \\ \hline \vdots & & & & \ddots & -1 & 2 & -1 & 0 & & & & & & 0 \\ & & & & & \ddots & -1 & \ddots & \ddots & \ddots & & & & & \vdots \\ & & & & & & 0 & \ddots & \ddots & -1 & -1 & & & & \\ & & & & & & & \ddots & -1 & 2 & 0 & & & & \\ 0 & \cdots & & \cdots & \cdots & \cdots & 0 & \cdots & -1 & 0 & 2 & & & & \end{array} \right)$$

Longest distinguished root:

$$-\alpha_0 = 2\alpha_1 + \dots + 2\alpha_{n+m-2} + \alpha_{n+m-1} + \alpha_{n+m} = 2\delta_1$$

Distinguished extended Dynkin diagram:

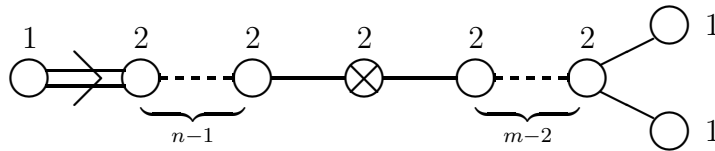

Factor group $\text{Out}(\mathcal{G}) = \text{Aut}(\mathcal{G})/\text{Int}(\mathcal{G}) = \mathbb{Z}_2$.

Table 10: The basic Lie superalgebra $F(4)$.

Structure: $\mathcal{G}_{\bar{0}} = sl(2) \oplus so(7)$ and $\mathcal{G}_{\bar{1}} = (2, 8)$, type II.

Rank: 4, dimension: 40.

Root system:

$$\begin{aligned}\Delta &= \{\pm\delta, \pm\varepsilon_i \pm \varepsilon_j, \pm\varepsilon_i, \frac{1}{2}(\pm\varepsilon_1 \pm \varepsilon_2 \pm \varepsilon_3 \pm \delta)\} \\ \Delta_{\bar{0}} &= \{\pm\delta, \pm\varepsilon_i \pm \varepsilon_j, \pm\varepsilon_i\}, \quad \Delta_{\bar{1}} = \{\frac{1}{2}(\pm\varepsilon_1 \pm \varepsilon_2 \pm \varepsilon_3 \pm \delta)\} \\ \overline{\Delta}_{\bar{0}} &= \Delta_{\bar{0}}, \quad \overline{\Delta}_{\bar{1}} = \Delta_{\bar{1}}\end{aligned}$$

where $1 \leq i \neq j \leq 3$.

$\dim \Delta_{\bar{0}} = \dim \overline{\Delta}_{\bar{0}} = 20$ and $\dim \Delta_{\bar{1}} = \dim \overline{\Delta}_{\bar{1}} = 16$.

Distinguished simple root system:

$$\alpha_1 = \frac{1}{2}(\delta - \varepsilon_1 - \varepsilon_2 - \varepsilon_3), \quad \alpha_2 = \varepsilon_3, \quad \alpha_3 = \varepsilon_2 - \varepsilon_3, \quad \alpha_4 = \varepsilon_1 - \varepsilon_2$$

Distinguished positive roots ($1 \leq i < j \leq 3$):

$$\begin{aligned}\varepsilon_i - \varepsilon_j &= \alpha_3, \alpha_4, \alpha_3 + \alpha_4 \\ \varepsilon_i + \varepsilon_j &= 2\alpha_2 + \alpha_3, 2\alpha_2 + \alpha_3 + \alpha_4, 2\alpha_2 + 2\alpha_3 + \alpha_4 \\ \varepsilon_i &= \alpha_2, \alpha_2 + \alpha_3, \alpha_2 + \alpha_3 + \alpha_4 \\ \delta &= 2\alpha_1 + 3\alpha_2 + 2\alpha_3 + \alpha_4\end{aligned}$$

$$\begin{aligned}\frac{1}{2}(\delta \pm \varepsilon_1 \pm \varepsilon_2 \pm \varepsilon_3) &= \alpha_1, \alpha_1 + \alpha_2, \alpha_1 + \alpha_2 + \alpha_3, \alpha_1 + \alpha_2 + \alpha_3 + \alpha_4, \alpha_1 + 2\alpha_2 + \alpha_3, \\ &\alpha_1 + 2\alpha_2 + \alpha_3 + \alpha_4, \alpha_1 + 2\alpha_2 + 2\alpha_3 + \alpha_4, \alpha_1 + 3\alpha_2 + 2\alpha_3 + \alpha_4\end{aligned}$$

Sums of even/odd distinguished positive roots:

$$\begin{aligned}2\rho_0 &= 5\varepsilon_1 + 3\varepsilon_2 + \varepsilon_3 + \delta \\ 2\rho_1 &= 4\delta\end{aligned}$$

Distinguished Dynkin diagram:

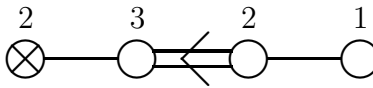

Distinguished Cartan matrix:

$$\begin{pmatrix} 0 & 1 & 0 & 0 \\ -1 & 2 & -2 & 0 \\ 0 & -1 & 2 & -1 \\ 0 & 0 & -1 & 2 \end{pmatrix}$$

Longest distinguished root:

$$-\alpha_0 = 2\alpha_1 + 3\alpha_2 + 2\alpha_3 + \alpha_4 = \delta$$

Distinguished extended Dynkin diagram:

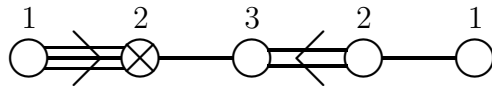

Factor group $\text{Out}(\mathcal{G}) = \text{Aut}(\mathcal{G})/\text{Int}(\mathcal{G}) = \mathbb{I}$.

Table 11: The basic Lie superalgebra $G(3)$.

Structure: $\mathcal{G}_{\bar{0}} = sl(2) \oplus G_2$ and $\mathcal{G}_{\bar{1}} = (2, 7)$, type II.

Rank: 3, dimension: 31.

Root system:

$$\begin{aligned}\Delta &= \{\pm 2\delta, \pm \varepsilon_i, \varepsilon_i - \varepsilon_j, \pm \delta, \pm \varepsilon_i \pm \delta\} \\ \Delta_{\bar{0}} &= \{\pm 2\delta, \pm \varepsilon_i, \varepsilon_i - \varepsilon_j\}, \quad \Delta_{\bar{1}} = \{\pm \delta, \pm \varepsilon_i \pm \delta\} \\ \bar{\Delta}_{\bar{0}} &= \{\pm \varepsilon_i, \varepsilon_i - \varepsilon_j\}, \quad \bar{\Delta}_{\bar{1}} = \{\pm \varepsilon_i \pm \delta\}\end{aligned}$$

where $1 \leq i \neq j \leq 3$ and $\varepsilon_1 + \varepsilon_2 + \varepsilon_3 = 0$.

$\dim \Delta_{\bar{0}} = 14$, $\dim \Delta_{\bar{1}} = 14$, $\dim \bar{\Delta}_{\bar{0}} = 12$, $\dim \bar{\Delta}_{\bar{1}} = 12$.

Distinguished simple root system:

$$\alpha_1 = \delta + \varepsilon_3, \quad \alpha_2 = \varepsilon_1, \quad \alpha_3 = \varepsilon_2 - \varepsilon_1$$

Distinguished positive roots:

even roots: $\alpha_2, \alpha_3, \alpha_2 + \alpha_3, 2\alpha_2 + \alpha_3, 3\alpha_2 + \alpha_3, 3\alpha_2 + 2\alpha_3, 2\alpha_1 + 4\alpha_2 + 2\alpha_3$

odd roots: $\alpha_1, \alpha_1 + \alpha_2, \alpha_1 + \alpha_2 + \alpha_3, \alpha_1 + 2\alpha_2 + \alpha_3, \alpha_1 + 3\alpha_2 + \alpha_3,$

$\alpha_1 + 3\alpha_2 + 2\alpha_3, \alpha_1 + 4\alpha_2 + 2\alpha_3$

Sums of even/odd distinguished positive roots:

$$2\rho_0 = 2\varepsilon_1 + 4\varepsilon_2 - 2\varepsilon_3 + 2\delta$$

$$2\rho_1 = 7\delta$$

Distinguished Dynkin diagram:

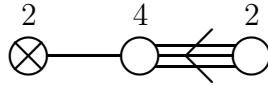

Distinguished Cartan matrix:

$$\begin{pmatrix} 0 & 1 & 0 \\ -1 & 2 & -3 \\ 0 & -1 & 2 \end{pmatrix}$$

Longest distinguished root:

$$-\alpha_0 = 2\alpha_1 + 4\alpha_2 + 2\alpha_3 = 2\delta$$

Distinguished extended Dynkin diagram:

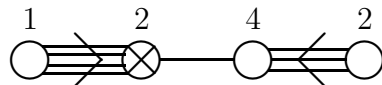

Factor group $\text{Out}(\mathcal{G}) = \text{Aut}(\mathcal{G})/\text{Int}(\mathcal{G}) = \mathbb{I}$.

Table 12: The basic Lie superalgebra $D(2, 1; \alpha)$.

Structure: $\mathcal{G}_{\bar{0}} = sl(2) \oplus sl(2) \oplus sl(2)$ and $\mathcal{G}_{\bar{1}} = (2, 2, 2)$, type II.

Rank: 3, dimension: 17.

Root system:

$$\begin{aligned}\Delta &= \{\pm 2\varepsilon_i, \pm\varepsilon_1 \pm \varepsilon_2 \pm \varepsilon_3\} \\ \Delta_{\bar{0}} &= \{\pm 2\varepsilon_i\}, \quad \Delta_{\bar{1}} = \{\pm\varepsilon_1 \pm \varepsilon_2 \pm \varepsilon_3\} \\ \overline{\Delta}_{\bar{0}} &= \Delta_{\bar{0}}, \quad \overline{\Delta}_{\bar{1}} = \Delta_{\bar{1}}\end{aligned}$$

where $1 \leq i \leq 3$.

$\dim \Delta_{\bar{0}} = \dim \overline{\Delta}_{\bar{0}} = 6$ and $\dim \Delta_{\bar{1}} = \dim \overline{\Delta}_{\bar{1}} = 8$.

Distinguished simple root system:

$$\alpha_1 = \varepsilon_1 - \varepsilon_2 - \varepsilon_3, \alpha_2 = 2\varepsilon_2, \alpha_3 = 2\varepsilon_3$$

Distinguished positive roots ($1 \leq j \leq 3$):

$$\text{even roots: } \alpha_2, \alpha_3, 2\alpha_1 + \alpha_2 + \alpha_3$$

$$\text{odd roots: } \alpha_1, \alpha_1 + \alpha_2, \alpha_1 + \alpha_3, \alpha_1 + \alpha_2 + \alpha_3$$

Sums of even/odd distinguished positive roots:

$$2\rho_0 = 2\varepsilon_1 + 2\varepsilon_2 + 2\varepsilon_3$$

$$2\rho_1 = 4\varepsilon_1$$

Distinguished Dynkin diagram:

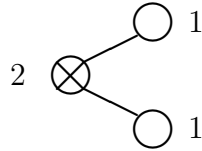

Distinguished Cartan matrix:

$$\begin{pmatrix} 0 & 1 & \alpha \\ -1 & 2 & 0 \\ -1 & 0 & 2 \end{pmatrix}$$

Longest root (in the distinguished root system):

$$-\alpha_0 = 2\alpha_1 + \alpha_2 + \alpha_3 = 2\varepsilon_1$$

Distinguished extended Dynkin diagram:

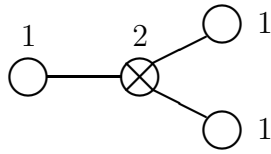

Factor group $\text{Out}(\mathcal{G}) = \text{Aut}(\mathcal{G})/\text{Int}(\mathcal{G})$:

$\text{Out}(\mathcal{G}) = \mathbb{I}$ for generic α

$\text{Out}(\mathcal{G}) = \mathbb{Z}_2$ for $\alpha = 1, -2, -1/2$

$\text{Out}(\mathcal{G}) = \mathbb{Z}_3$ for $\alpha = e^{2i\pi/3}, e^{4i\pi/3}$

Table 13: Distinguished Dynkin diagrams of the basic Lie superalgebras.

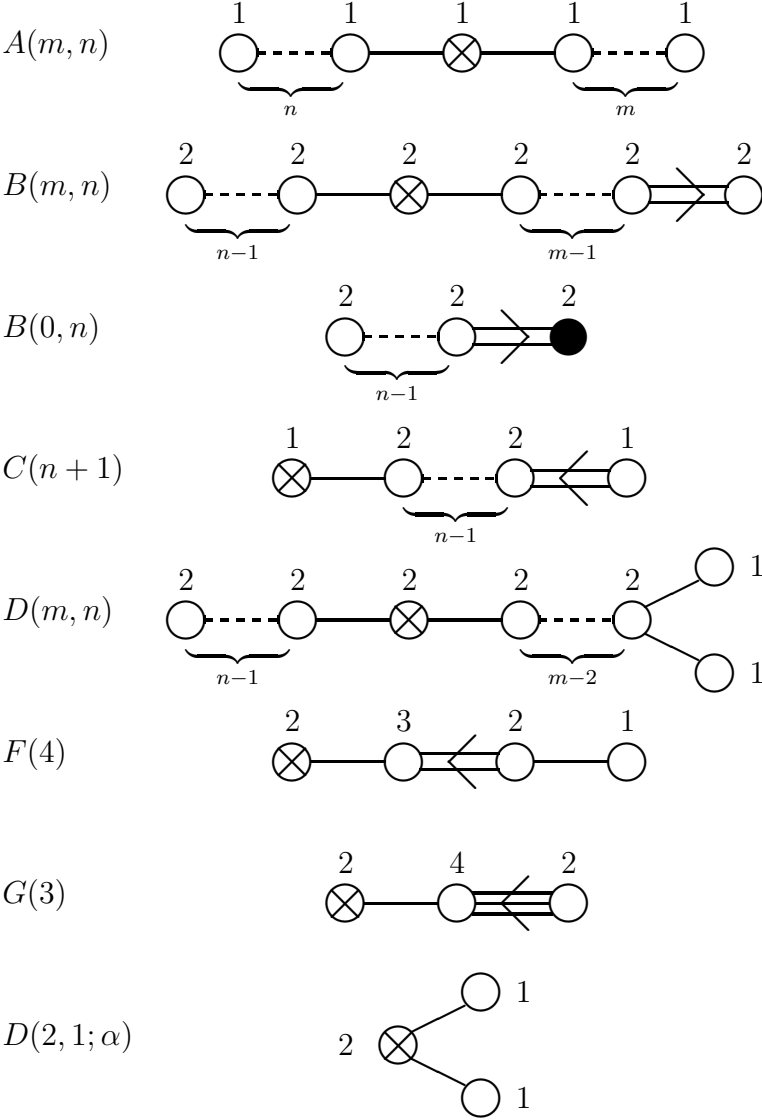
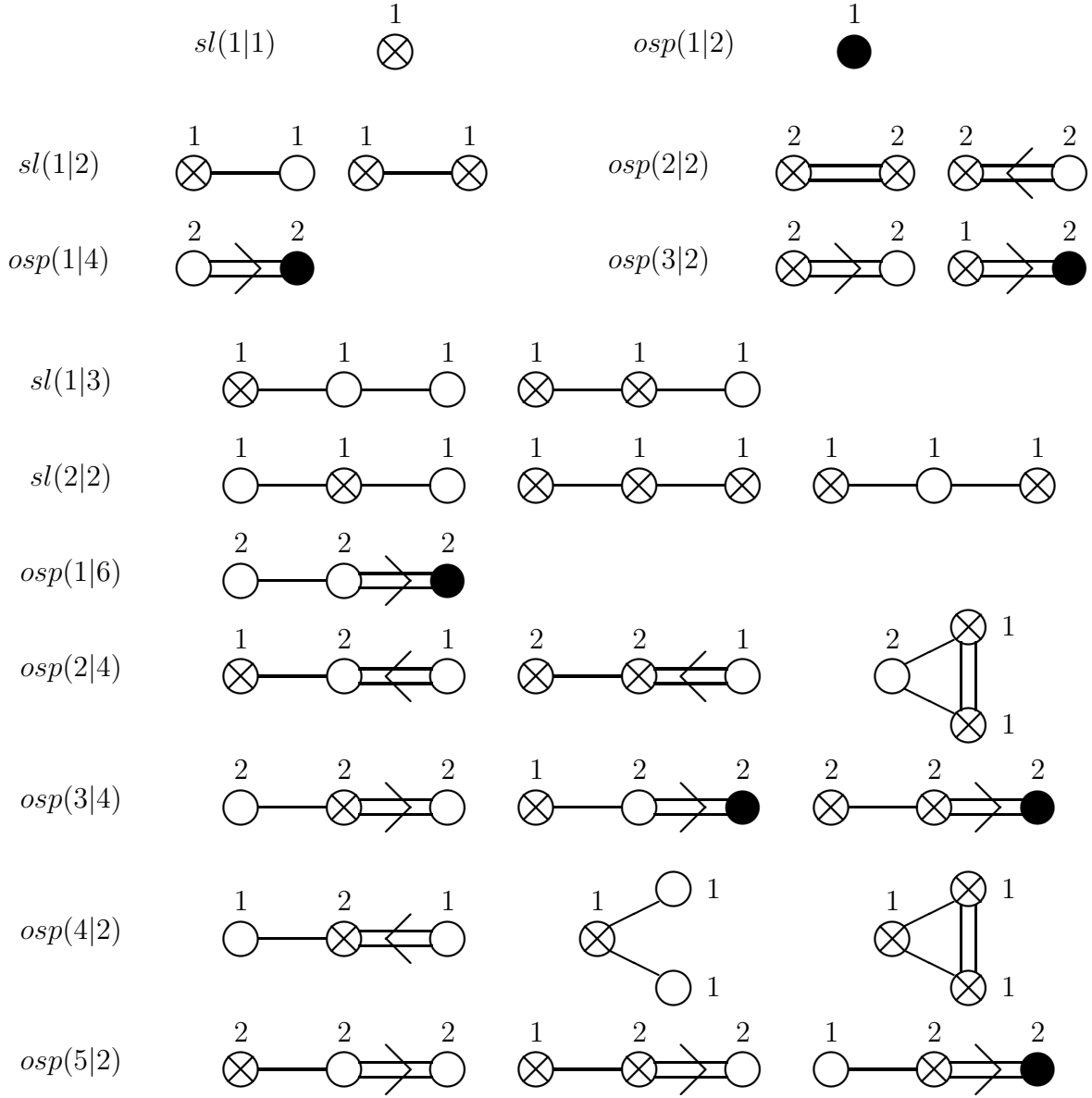
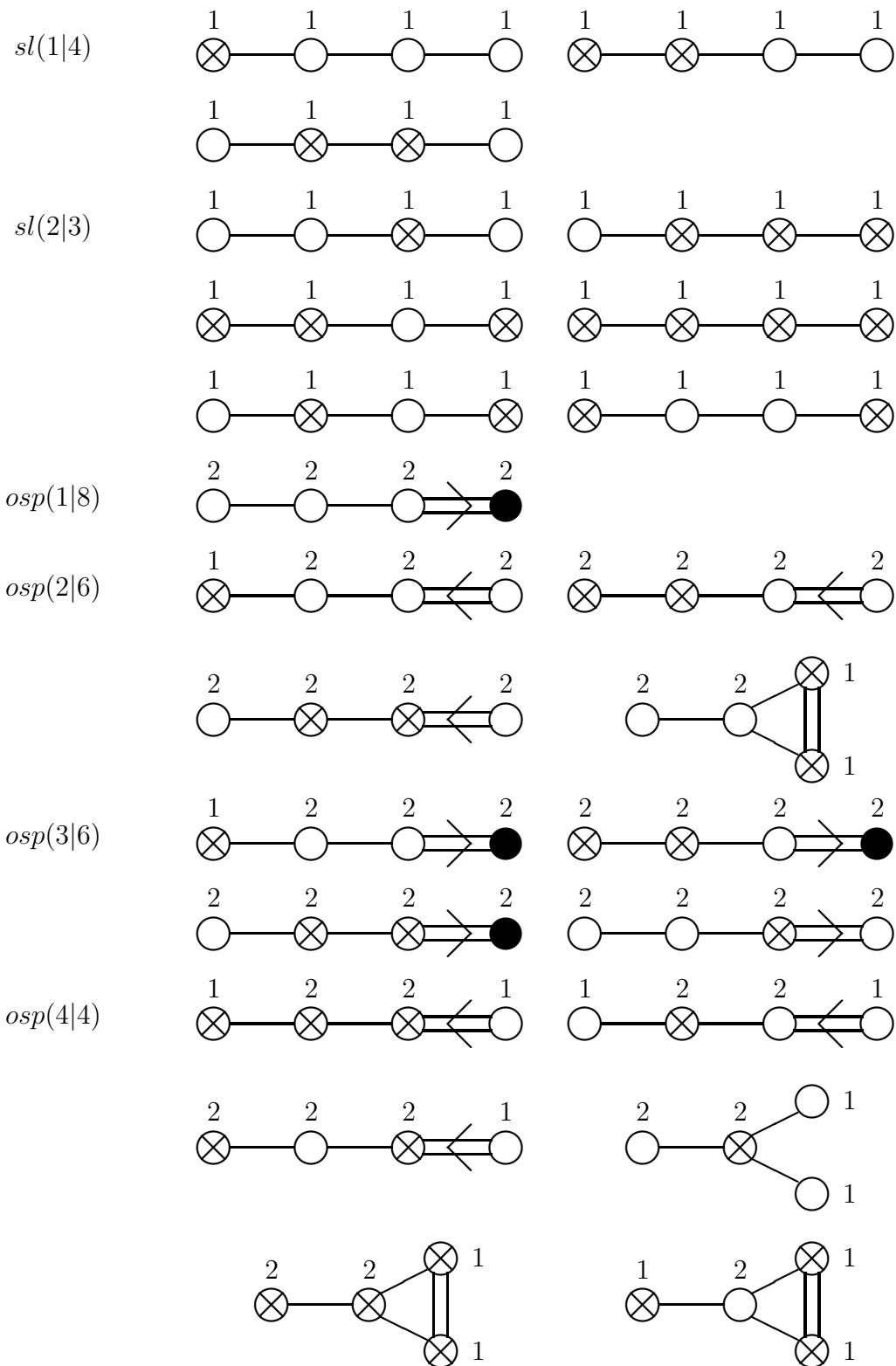

Table 14: Dynkin diagrams of the basic Lie superalgebras of rank ≤ 4





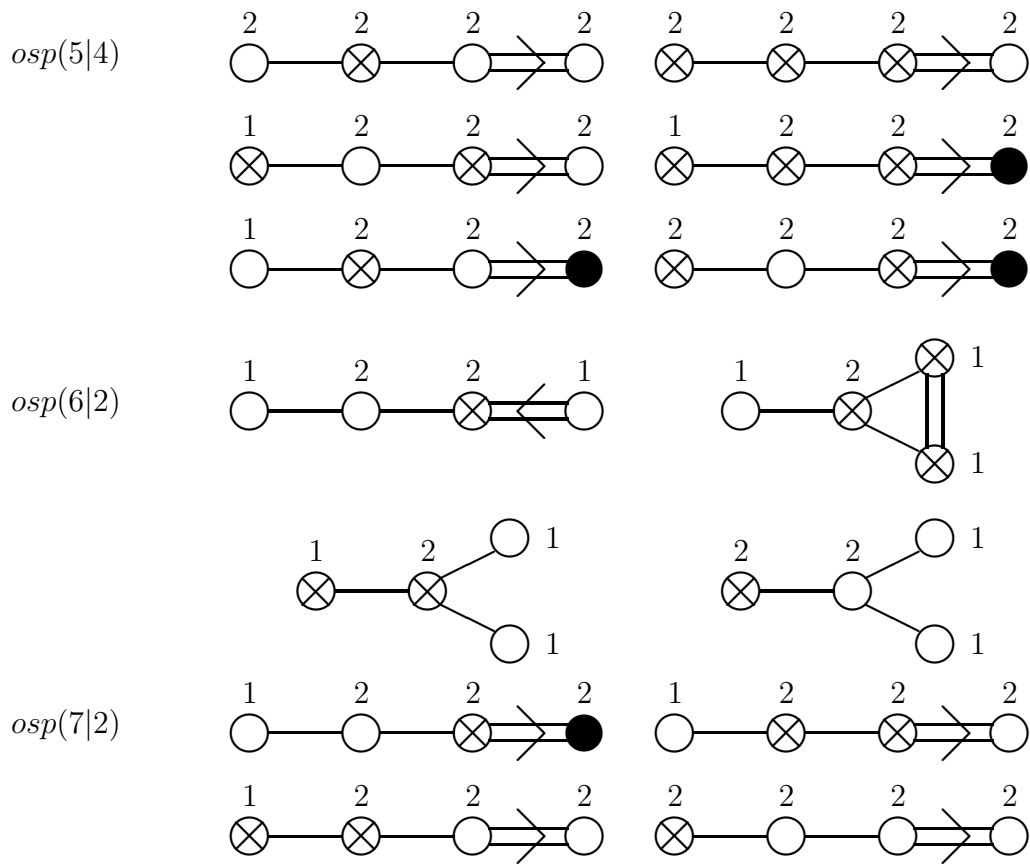
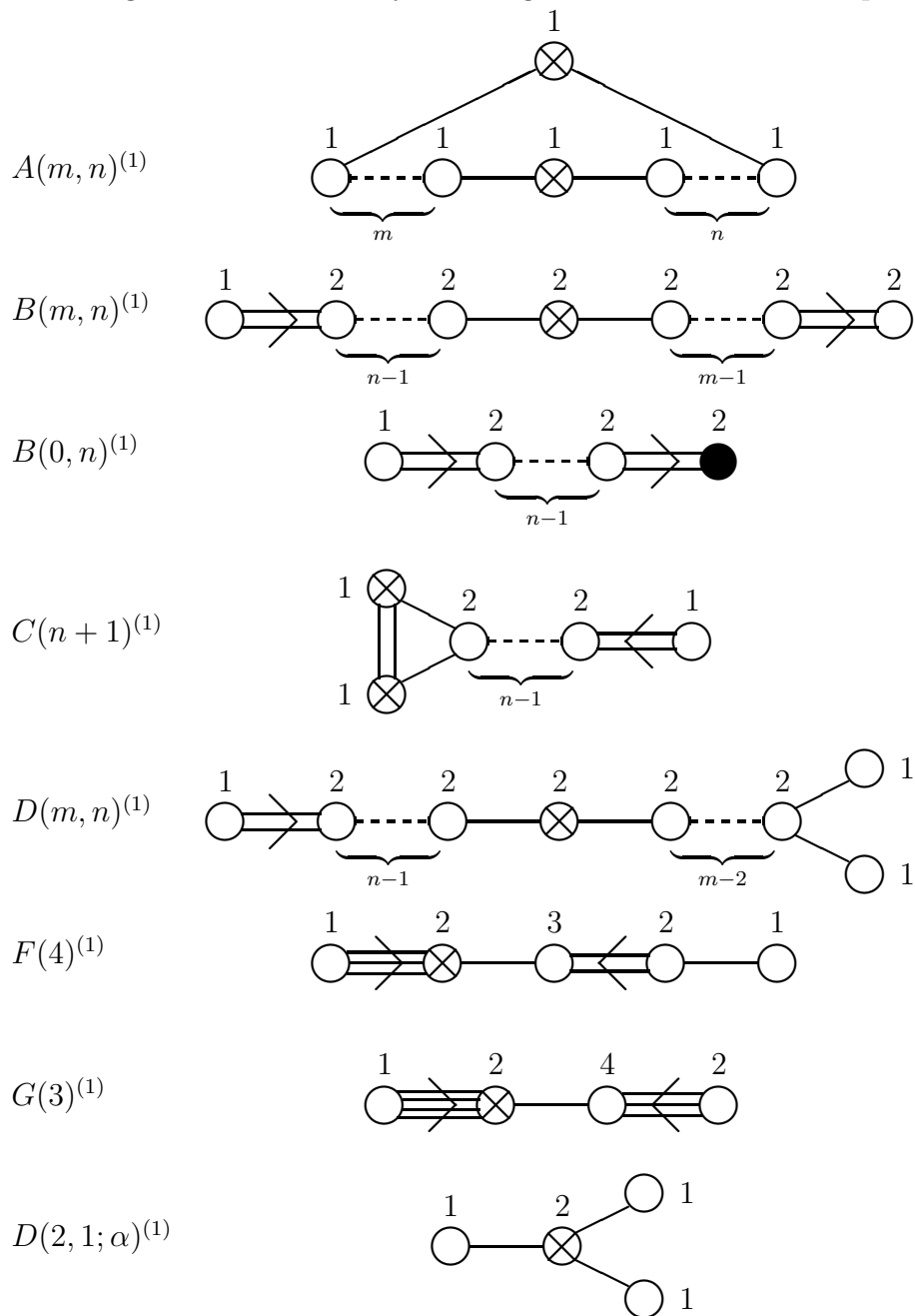

Table 15: Distinguished extended Dynkin diagrams of the basic Lie superalgebras.



| \mathcal{G} | $\mathcal{G}_{\bar{0}}$ | \mathcal{G}^{ϕ} | $\mathcal{G}_{\bar{0}}^{\phi}$ |
|------------------------|--------------------------------------|---|--|
| $A(m, n)$ | $sl(m) \oplus sl(n) \oplus U(1)$ | $sl(m n; \mathbb{R})$ $sl(m n; \mathbb{H})$ $su(p, m-p q, n-q)$ | $sl(m, \mathbb{R}) \oplus sl(n, \mathbb{R}) \oplus \mathbb{R}$ $su^*(m) \oplus su^*(n) \oplus \mathbb{R}$ $su(p, m-p) \oplus su(q, n-q) \oplus i\mathbb{R}$ |
| $A(n, n)$ | $sl(n) \oplus sl(n)$ | $sl(n n; \mathbb{R})$ $sl(n n; \mathbb{H})$ $su(p, n-p q, n-q)$ | $sl(n, \mathbb{R}) \oplus sl(n, \mathbb{R})$ $su^*(n) \oplus su^*(n)$ $su(p, n-p) \oplus su(q, n-q)$ |
| $B(m, n)$ $B(0, n)$ | $so(2m+1) \oplus sp(2n)$ $sp(2n)$ | $osp(p, 2m+1-p 2n; \mathbb{R})$ $osp(1 2n; \mathbb{R})$ | $so(p, 2m+1-p) \oplus sp(2n, \mathbb{R})$ $sp(2n, \mathbb{R})$ |
| $C(n+1)$ | $so(2) \oplus sp(2n)$ | $osp(2 2n; \mathbb{R})$ $osp(2 2q, 2n-2q; \mathbb{H})$ | $so(2) \oplus sp(2n, \mathbb{R})$ $so^*(2) \oplus sp(2q, 2n-2q)$ |
| $D(m, n)$ | $so(2m) \oplus sp(2n)$ | $osp(p, 2m-p 2n; \mathbb{R})$ $osp(2m 2q, 2n-2q; \mathbb{H})$ | $so(p, 2m-p) \oplus sp(2n, \mathbb{R})$ $so^*(2m) \oplus sp(2q, 2n-2q)$ |
| $F(4)$ | $sl(2) \oplus so(7)$ | $F(4; 0)$ $F(4; 3)$ $F(4; 2)$ $F(4; 1)$ | $sl(2, \mathbb{R}) \oplus so(7)$ $sl(2, \mathbb{R}) \oplus so(1, 6)$ $sl(2, \mathbb{R}) \oplus so(2, 5)$ $sl(2, \mathbb{R}) \oplus so(3, 4)$ |
| $G(3)$ | $sl(2) \oplus G_2$ | $G(3; 0)$ $G(3; 1)$ | $sl(2, \mathbb{R}) \oplus G_{2,0}$ $sl(2, \mathbb{R}) \oplus G_{2,2}$ |
| $D(2, 1; \alpha)$ | $sl(2) \oplus sl(2) \oplus sl(2)$ | $D(2, 1; \alpha; 0)$ $D(2, 1; \alpha; 1)$ $D(2, 1; \alpha; 2)$ | $sl(2, \mathbb{R}) \oplus sl(2, \mathbb{R}) \oplus sl(2, \mathbb{R})$ $su(2) \oplus su(2) \oplus sl(2, \mathbb{R})$ $sl(2, \mathbb{C}) \oplus sl(2, \mathbb{R})$ |
| $P(n)$ | $sl(n)$ | $P(n; \mathbb{R})$ | $sl(n, \mathbb{R})$ |
| $Q(n)$ | $sl(n)$ | $Q(n; \mathbb{R})$ $HQ(n)$ $UQ(p, n-p)$ | $sl(n, \mathbb{R})$ $su^*(n)$ $su(p, n-p)$ |

Table 16: Real forms of the classical Lie superalgebras.

| \mathcal{G} | \mathcal{K} | fund $\mathcal{G} / \mathcal{K}$ |
|----------------|--|--|
| $sl(m n)$ | $sl(p+1 p)$ $sl(p p+1)$ | $\mathcal{R}_{p/2} \oplus (m-p-1)\mathcal{R}_0 \oplus (n-p)\mathcal{R}_0''$ $\mathcal{R}_{p/2}'' \oplus (m-p)\mathcal{R}_0 \oplus (n-p-1)\mathcal{R}_0''$ |
| $osp(2m 2n)$ | $osp(2k 2k)$ $osp(2k+2 2k)$ $sl(p+1 p)$ $sl(p p+1)$ | $\mathcal{R}_{k-1/2}'' \oplus (2n-2k)\mathcal{R}_0'' \oplus (2m-2k+1)\mathcal{R}_0$ $\mathcal{R}_k \oplus (2m-2k-1)\mathcal{R}_0 \oplus (2n-2k)\mathcal{R}_0''$ $2\mathcal{R}_{p/2} \oplus 2(m-p-1)\mathcal{R}_0 \oplus 2(n-p)\mathcal{R}_0''$ $2\mathcal{R}_{p/2}'' \oplus 2(n-p-1)\mathcal{R}_0'' \oplus 2(m-p)\mathcal{R}_0$ |
| $osp(2m+1 2n)$ | $\left. \begin{array}{l} osp(2k 2k) \\ osp(2k-1 2k) \end{array} \right\}$ $\left. \begin{array}{l} osp(2k+2 2k) \\ osp(2k+1 2k) \end{array} \right\}$ $sl(p+1 p)$ $sl(p p+1)$ | $\mathcal{R}_{k-1/2}'' \oplus (2n-2k)\mathcal{R}_0'' \oplus (2m-2k+2)\mathcal{R}_0$ $\mathcal{R}_k \oplus (2m-2k)\mathcal{R}_0 \oplus (2n-2k)\mathcal{R}_0''$ $2\mathcal{R}_{p/2} \oplus 2(m-p-1)\mathcal{R}_0 \oplus \mathcal{R}_0 \oplus 2(n-p)\mathcal{R}_0''$ $2\mathcal{R}_{p/2}'' \oplus 2(n-p-1)\mathcal{R}_0'' \oplus \mathcal{R}_0 \oplus 2(m-p)\mathcal{R}_0$ |
| $osp(2 2n)$ | $osp(2 2)$ $sl(1 2)$ | $\mathcal{R}_{1/2}'' \oplus \mathcal{R}_0 \oplus (2n-2)\mathcal{R}_0''$ $2\mathcal{R}_{1/2}'' \oplus (2n-4)\mathcal{R}_0''$ |

Table 17: $osp(1|2)$ decompositions of the fundamental representations of the basic Lie superalgebras (regular cases).

$\rightarrow osp(1|2)$ decompositions

| \mathcal{G} | \mathcal{K} | fund $\mathcal{G} / \mathcal{K}$ |
|------------------|--|--|
| $osp(2n + 2 2n)$ | $osp(2k + 1 2k) \oplus$ $osp(2n - 2k + 1 2n - 2k)$ | $\mathcal{R}_k \oplus \mathcal{R}_{n-k}$ |
| $osp(2n - 2 2n)$ | $osp(2k - 1 2k) \oplus$ $osp(2n - 2k - 1 2n - 2k)$ | $\mathcal{R}''_{k-1/2} \oplus \mathcal{R}''_{n-k-1/2}$ |
| $osp(2n 2n)$ | $osp(2k + 1 2k) \oplus$ $osp(2n - 2k - 1 2n - 2k)$ $osp(2k - 1 2k) \oplus$ $osp(2n - 2k + 1 2n - 2k)$ | $\mathcal{R}_k \oplus \mathcal{R}''_{n-k-1/2}$ $\mathcal{R}_{n-k} \oplus \mathcal{R}''_{k-1/2}$ |

Table 18: $osp(1|2)$ decompositions of the fundamental representations of the basic Lie superalgebras (singular cases).

→ $osp(1|2)$ decompositions

Table 19: $osp(1|2)$ decompositions of the adjoint representations of the basic Lie superalgebras (regular cases).

$$\begin{aligned} \frac{\text{ad } osp(2m|2n)}{osp(2k|2k)} = & \\ & \mathcal{R}_{2k-1} \oplus \mathcal{R}_{2k-5/2} \oplus \mathcal{R}_{2k-3} \oplus \mathcal{R}_{2k-9/2} \oplus \dots \oplus \mathcal{R}_{3/2} \oplus \mathcal{R}_1 \\ & \oplus (2m - 2k + 1)\mathcal{R}_{k-1/2} \oplus 2(n - k)\mathcal{R}'_{k-1/2} \oplus 2(2m - 2k + 1)(n - k)\mathcal{R}'_0 \\ & \oplus [(2m - 2k + 1)(m - k) + (2n - 2k + 1)(n - k)]\mathcal{R}_0 \end{aligned}$$

$$\begin{aligned} \frac{\text{ad } osp(2m|2n)}{osp(2k+2|2k)} = & \\ & \mathcal{R}_{2k-1/2} \oplus \mathcal{R}_{2k-1} \oplus \mathcal{R}_{2k-5/2} \oplus \mathcal{R}_{2k-3} \oplus \dots \oplus \mathcal{R}_{3/2} \oplus \mathcal{R}_1 \\ & \oplus (2m - 2k - 1)\mathcal{R}_k \oplus 2(n - k)\mathcal{R}'_k \oplus 2(2m - 2k - 1)(n - k)\mathcal{R}'_0 \\ & \oplus [(2m - 2k - 1)(m - k - 1) + (2n - 2k + 1)(n - k)]\mathcal{R}_0 \end{aligned}$$

$$\begin{aligned} \frac{\text{ad } osp(2m|2n)}{sl(2k+1|2k)} = & \\ & \mathcal{R}_{2k} \oplus 3\mathcal{R}_{2k-1} \oplus \mathcal{R}_{2k-2} \oplus \dots \oplus \mathcal{R}_2 \oplus 3\mathcal{R}_1 \oplus \mathcal{R}_0 \\ & \oplus 3\mathcal{R}_{2k-1/2} \oplus \mathcal{R}_{2k-3/2} \oplus 3\mathcal{R}_{2k-5/2} \oplus \dots \oplus 3\mathcal{R}_{3/2} \oplus \mathcal{R}_{1/2} \\ & \oplus 4(m - 2k - 1)\mathcal{R}_k \oplus 4(n - 2k)\mathcal{R}'_k \oplus 4(m - 2k - 1)(n - 2k)\mathcal{R}'_0 \\ & \oplus [(2m - 4k - 3)(m - 2k - 1) + (2n - 4k + 1)(n - 2k)]\mathcal{R}_0 \end{aligned}$$

$$\begin{aligned} \frac{\text{ad } osp(2m|2n)}{sl(2k-1|2k)} = & \\ & 3\mathcal{R}_{2k-1} \oplus \mathcal{R}_{2k-2} \oplus 3\mathcal{R}_{2k-3} \oplus \dots \oplus \mathcal{R}_2 \oplus 3\mathcal{R}_1 \oplus \mathcal{R}_0 \\ & \oplus \mathcal{R}_{2k-3/2} \oplus 3\mathcal{R}_{2k-5/2} \oplus \mathcal{R}_{2k-7/2} \oplus \dots \oplus 3\mathcal{R}_{3/2} \oplus \mathcal{R}_{1/2} \\ & \oplus 4(m - 2k + 1)\mathcal{R}_{k-1/2} \oplus 4(n - 2k)\mathcal{R}'_{k-1/2} \oplus 4(m - 2k + 1)(n - 2k)\mathcal{R}'_0 \\ & \oplus [(2m - 4k + 1)(m - 2k + 1) + (2n - 4k + 1)(n - 2k)]\mathcal{R}_0 \end{aligned}$$

$$\begin{aligned} \frac{\text{ad } osp(2m|2n)}{sl(2k|2k+1)} = & \\ & 3\mathcal{R}_{2k} \oplus \mathcal{R}_{2k-1} \oplus 3\mathcal{R}_{2k-2} \oplus \dots \oplus 3\mathcal{R}_2 \oplus \mathcal{R}_1 \oplus 3\mathcal{R}_0 \\ & \oplus \mathcal{R}_{2k-1/2} \oplus 3\mathcal{R}_{2k-3/2} \oplus \mathcal{R}_{2k-5/2} \oplus \dots \oplus \mathcal{R}_{3/2} \oplus 3\mathcal{R}_{1/2} \\ & \oplus 4(m - 2k)\mathcal{R}'_k \oplus 4(n - 2k - 1)\mathcal{R}_k \oplus 4(m - 2k)(n - 2k - 1)\mathcal{R}'_0 \\ & \oplus [(2m - 4k - 1)(m - 2k) + (2n - 4k - 1)(n - 2k - 1)]\mathcal{R}_0 \end{aligned}$$

$$\begin{aligned}
\frac{\text{ad } osp(2m|2n)}{sl(2k|2k-1)} = & \\
& \mathcal{R}_{2k-1} \oplus 3\mathcal{R}_{2k-2} \oplus \mathcal{R}_{2k-3} \oplus \dots \oplus 3\mathcal{R}_2 \oplus \mathcal{R}_1 \oplus 3\mathcal{R}_0 \\
& \oplus 3\mathcal{R}_{2k-3/2} \oplus \mathcal{R}_{2k-5/2} \oplus 3\mathcal{R}_{2k-7/2} \oplus \dots \oplus \mathcal{R}_{3/2} \oplus 3\mathcal{R}_{1/2} \\
& \oplus 4(m-2k)\mathcal{R}'_{k-1/2} \oplus 4(n-2k+1)\mathcal{R}_{k-1/2} \oplus 4(m-2k)(n-2k+1)\mathcal{R}'_0 \\
& \oplus [(2m-4k-1)(m-2k) + (2n-4k+3)(n-2k+1)]\mathcal{R}_0
\end{aligned}$$

$$\begin{aligned}
\frac{\text{ad } osp(2m+1|2n)}{osp(2k|2k)} = \frac{\text{ad } osp(2m+1|2n)}{osp(2k-1|2k)} = & \\
& \mathcal{R}_{2k-1} \oplus \mathcal{R}_{2k-5/2} \oplus \mathcal{R}_{2k-3} \oplus \mathcal{R}_{2k-9/2} \oplus \dots \oplus \mathcal{R}_{3/2} \oplus \mathcal{R}_1 \\
& \oplus 2(m-k+1)\mathcal{R}_{k-1/2} \oplus 2(n-k)\mathcal{R}'_{k-1/2} \oplus 4(m-k+1)(n-k)\mathcal{R}'_0 \\
& \oplus [(2m-2k+1)(m-k+1) + (2n-2k+1)(n-k)]\mathcal{R}_0
\end{aligned}$$

$$\begin{aligned}
\frac{\text{ad } osp(2m+1|2n)}{osp(2k+2|2k)} = \frac{\text{ad } osp(2m+1|2n)}{osp(2k+1|2k)} = & \\
& \mathcal{R}_{2k-1/2} \oplus \mathcal{R}_{2k-1} \oplus \mathcal{R}_{2k-5/2} \oplus \mathcal{R}_{2k-3} \oplus \dots \oplus \mathcal{R}_{3/2} \oplus \mathcal{R}_1 \\
& \oplus 2(n-k)\mathcal{R}'_k \oplus 2(m-k)\mathcal{R}_k \oplus 4(m-k)(n-k)\mathcal{R}'_0 \\
& \oplus [(2m-2k-1)(m-k) + (2n-2k+1)(n-k)]\mathcal{R}_0
\end{aligned}$$

$$\frac{\text{ad } osp(2|2n)}{osp(2|2)} = \mathcal{R}_1 \oplus \mathcal{R}_{1/2} \oplus (2n-2)\mathcal{R}'_{1/2} \oplus (2n^2-3n+1)\mathcal{R}_0 \oplus (2n-2)\mathcal{R}'_0$$

$$\frac{\text{ad } osp(2|2n)}{sl(1|2)} = 3\mathcal{R}_1 \oplus \mathcal{R}_{1/2} \oplus (4n-8)\mathcal{R}'_{1/2} \oplus (2n^2-7n+7)\mathcal{R}_0$$

→ $osp(1|2)$ decompositions

Table 20: $osp(1|2)$ decompositions of the adjoint representations of the basic Lie superalgebras (singular cases).

$$\frac{\text{ad } osp(2n+2|2n)}{osp(2k+1|2k) \oplus osp(2n-2k+1|2n-2k)} =$$

$$\begin{aligned} & \mathcal{R}_{2n-2k-1} \oplus \mathcal{R}_{2n-2k-3} \oplus \dots \oplus \mathcal{R}_1 \oplus \mathcal{R}_{2n-2k-1/2} \oplus \mathcal{R}_{2n-2k-3/2} \oplus \dots \\ & \oplus \mathcal{R}_{3/2} \oplus \mathcal{R}_{2k-1} \oplus \mathcal{R}_{2k-3} \oplus \dots \oplus \mathcal{R}_1 \oplus \mathcal{R}_{2k-1/2} \oplus \mathcal{R}_{2k-3/2} \\ & \oplus \dots \oplus \mathcal{R}_{3/2} \oplus \mathcal{R}_n \oplus \mathcal{R}_{n-1} \oplus \dots \oplus \mathcal{R}_{n-2k} \\ & \oplus \mathcal{R}_{n-1/2} \oplus \mathcal{R}_{n-3/2} \oplus \dots \oplus \mathcal{R}_{n-2k+1/2} \end{aligned}$$

$$\frac{\text{ad } [osp(2n-2|2n)]}{osp(2k-1|2k) \oplus osp(2n-2k-1|2n-2k)} =$$

$$\begin{aligned} & \mathcal{R}_{2n-2k-1} \oplus \mathcal{R}_{2n-2k-3} \oplus \dots \oplus \mathcal{R}_1 \oplus \mathcal{R}_{2n-2k-5/2} \oplus \mathcal{R}_{2n-2k-7/2} \oplus \dots \\ & \oplus \mathcal{R}_{3/2} \oplus \mathcal{R}_{2k-1} \oplus \mathcal{R}_{2k-3} \oplus \dots \oplus \mathcal{R}_1 \oplus \mathcal{R}_{2k-5/2} \oplus \mathcal{R}_{2k-7/2} \\ & \oplus \dots \oplus \mathcal{R}_{3/2} \oplus \mathcal{R}_{n-1} \oplus \mathcal{R}_{n-2} \oplus \dots \oplus \mathcal{R}_{n-2k} \\ & \oplus \mathcal{R}_{n-3/2} \oplus \mathcal{R}_{n-5/2} \oplus \dots \oplus \mathcal{R}_{n-2k+1/2} \end{aligned}$$

$$\frac{\text{ad } [osp(2n|2n)]}{osp(2k+1|2k) \oplus osp(2n-2k-1|2n-2k)} =$$

$$\begin{aligned} & \mathcal{R}_{2n-2k-1} \oplus \mathcal{R}_{2n-2k-3} \oplus \dots \oplus \mathcal{R}_1 \oplus \mathcal{R}_{2n-2k-5/2} \oplus \mathcal{R}_{2n-2k-7/2} \oplus \dots \\ & \oplus \mathcal{R}_{3/2} \oplus \mathcal{R}_{2k-1} \oplus \mathcal{R}_{2k-3} \oplus \dots \oplus \mathcal{R}_1 \oplus \mathcal{R}_{2k-1/2} \oplus \mathcal{R}_{2k-3/2} \\ & \oplus \dots \oplus \mathcal{R}_{3/2} \oplus \mathcal{R}_{n-1} \oplus \mathcal{R}_{n-2} \oplus \dots \oplus \mathcal{R}_{n-2k} \\ & \oplus \mathcal{R}_{n-1/2} \oplus \mathcal{R}_{n-3/2} \oplus \dots \oplus \mathcal{R}_{n-2k-1/2} \end{aligned}$$

$$\frac{\text{ad } [osp(2n|2n)]}{osp(2k-1|2k) \oplus osp(2n-2k+1|2n-2k)} =$$

$$\begin{aligned} & \mathcal{R}_{2n-2k-1} \oplus \mathcal{R}_{2n-2k-3} \oplus \dots \oplus \mathcal{R}_1 \oplus \mathcal{R}_{2n-2k-1/2} \oplus \mathcal{R}_{2n-2k-3/2} \oplus \dots \\ & \oplus \mathcal{R}_{3/2} \oplus \mathcal{R}_{2k-1} \oplus \mathcal{R}_{2k-3} \oplus \dots \oplus \mathcal{R}_1 \oplus \mathcal{R}_{2k-5/2} \oplus \mathcal{R}_{2k-7/2} \\ & \oplus \dots \oplus \mathcal{R}_{3/2} \oplus \mathcal{R}_{n-1} \oplus \mathcal{R}_{n-2} \oplus \dots \oplus \mathcal{R}_{n-2k+1} \\ & \oplus \mathcal{R}_{n-1/2} \oplus \mathcal{R}_{n-3/2} \oplus \dots \oplus \mathcal{R}_{n-2k+1/2} \end{aligned}$$

→ $osp(1|2)$ decompositions

| \mathcal{G} | SSA in \mathcal{G} | Decomposition of the fundamental of \mathcal{G} | Decomposition of the adjoint of \mathcal{G} |
|---------------|-------------------------------------|---|--|
| $A(0, 1)$ | $A(0, 1)$ | $\mathcal{R}''_{1/2}$ | $\mathcal{R}_1 \oplus \mathcal{R}_{1/2}$ |
| $A(0, 2)$ | $A(0, 1)$ | $\mathcal{R}''_{1/2} \oplus \mathcal{R}''_0$ | $\mathcal{R}_1 \oplus \mathcal{R}_{1/2} \oplus 2\mathcal{R}'_{1/2} \oplus \mathcal{R}_0$ |
| $A(1, 1)$ | $A(0, 1)$ | $\mathcal{R}''_{1/2} \oplus \mathcal{R}_0$ | $\mathcal{R}_1 \oplus 3\mathcal{R}_{1/2}$ |
| $A(0, 3)$ | $A(0, 1)$ | $\mathcal{R}''_{1/2} \oplus 2\mathcal{R}''_0$ | $\mathcal{R}_1 \oplus \mathcal{R}_{1/2} \oplus 4\mathcal{R}'_{1/2} \oplus 4\mathcal{R}_0$ |
| $A(1, 2)$ | $A(1, 2)$ $A(0, 1)$ $A(1, 0)$ | \mathcal{R}''_1 $\mathcal{R}''_{1/2} \oplus \mathcal{R}_0 \oplus \mathcal{R}''_0$ $\mathcal{R}_{1/2} \oplus 2\mathcal{R}''_0$ | $\mathcal{R}_2 \oplus \mathcal{R}_{3/2} \oplus \mathcal{R}_1 \oplus \mathcal{R}_{1/2}$ $\mathcal{R}_1 \oplus 3\mathcal{R}_{1/2} \oplus 2\mathcal{R}'_{1/2} \oplus 2\mathcal{R}_0 \oplus 2\mathcal{R}'_0$ $\mathcal{R}_1 \oplus 5\mathcal{R}_{1/2} \oplus 4\mathcal{R}_0$ |

Table 21: $osp(1|2)$ decompositions of the $A(m, n)$ superalgebras up to rank 4.

| \mathcal{G} | SSA in \mathcal{G} | Decomposition of the fundamental of \mathcal{G} | Decomposition of the adjoint of \mathcal{G} |
|---------------|---|--|--|
| $B(0, 2)$ | $B(0, 1)$ | $\mathcal{R}''_{1/2} \oplus 2\mathcal{R}''_0$ | $\mathcal{R}_1 \oplus 2\mathcal{R}'_{1/2} \oplus 3\mathcal{R}_0$ |
| $B(1, 1)$ | $B(1, 1)$ $C(2), B(0, 1)$ | \mathcal{R}_1 $\mathcal{R}''_{1/2} \oplus 2\mathcal{R}_0$ | $\mathcal{R}_{3/2} \oplus \mathcal{R}_1$ $\mathcal{R}_1 \oplus 2\mathcal{R}_{1/2} \oplus \mathcal{R}_0$ |
| $B(0, 3)$ | $B(0, 1)$ | $\mathcal{R}''_{1/2} \oplus 4\mathcal{R}''_0$ | $\mathcal{R}_1 \oplus 4\mathcal{R}'_{1/2} \oplus 10\mathcal{R}_0$ |
| $B(1, 2)$ | $B(1, 2)$ $B(1, 1)$ $C(2), B(0, 1)$ $C(2) \oplus B(0, 1), A(0, 1)$ | $\mathcal{R}''_{3/2}$ $\mathcal{R}_1 \oplus 2\mathcal{R}''_0$ $\mathcal{R}''_{1/2} \oplus 2\mathcal{R}_0 \oplus 2\mathcal{R}''_0$ $2\mathcal{R}''_{1/2} \oplus \mathcal{R}_0$ | $\mathcal{R}_3 \oplus \mathcal{R}_{3/2} \oplus \mathcal{R}_1$ $\mathcal{R}_{3/2} \oplus \mathcal{R}_1 \oplus 2\mathcal{R}'_1 \oplus 3\mathcal{R}_0$ $\mathcal{R}_1 \oplus 2\mathcal{R}_{1/2} \oplus 2\mathcal{R}'_{1/2} \oplus 4\mathcal{R}_0 \oplus 4\mathcal{R}'_0$ $3\mathcal{R}_1 \oplus 3\mathcal{R}_{1/2} \oplus \mathcal{R}_0$ |
| $B(2, 1)$ | $D(2, 1), B(1, 1)$ $C(2), B(0, 1)$ $A(1, 0)$ | $\mathcal{R}_1 \oplus 2\mathcal{R}_0$ $\mathcal{R}''_{1/2} \oplus 4\mathcal{R}_0$ $2\mathcal{R}_{1/2} \oplus \mathcal{R}_0$ | $\mathcal{R}_{3/2} \oplus 3\mathcal{R}_1 \oplus \mathcal{R}_0$ $\mathcal{R}_1 \oplus 4\mathcal{R}_{1/2} \oplus 6\mathcal{R}_0$ $\mathcal{R}_1 \oplus 3\mathcal{R}_{1/2} \oplus 2\mathcal{R}'_{1/2} \oplus 3\mathcal{R}_0$ |

Table 22: $osp(1|2)$ decompositions of the $B(m, n)$ superalgebras of rank 2 and 3.

| \mathcal{G} | SSA in \mathcal{G} | Decomposition of the fundamental of \mathcal{G} | Decomposition of the adjoint of \mathcal{G} |
|---------------|--|--|--|
| $B(0,4)$ | $B(0,1)$ | $\mathcal{R}''_{1/2} \oplus 6\mathcal{R}''_0$ | $\mathcal{R}_1 \oplus 6\mathcal{R}'_{1/2} \oplus 21\mathcal{R}_0$ |
| $B(1,3)$ | $B(1,2)$ $B(1,1)$ $C(2) \oplus B(0,1), A(0,1)$ $C(2), B(0,1)$ | $\mathcal{R}''_{3/2} \oplus 2\mathcal{R}''_0$ $\mathcal{R}_1 \oplus 4\mathcal{R}''_0$ $2\mathcal{R}''_{1/2} \oplus \mathcal{R}_0 \oplus 2\mathcal{R}''_0$ $\mathcal{R}''_{1/2} \oplus 4\mathcal{R}''_0 \oplus 2\mathcal{R}_0$ | $\mathcal{R}_3 \oplus \mathcal{R}_{3/2} \oplus 2\mathcal{R}'_{3/2} \oplus \mathcal{R}_1 \oplus 3\mathcal{R}_0$ $\mathcal{R}_{3/2} \oplus \mathcal{R}_1 \oplus 4\mathcal{R}'_1 \oplus 10\mathcal{R}_0$ $3\mathcal{R}_1 \oplus 3\mathcal{R}_{1/2} \oplus 4\mathcal{R}'_{1/2} \oplus 4\mathcal{R}_0 \oplus 2\mathcal{R}'_0$ $\mathcal{R}_1 \oplus 2\mathcal{R}_{1/2} \oplus 4\mathcal{R}'_{1/2} \oplus 11\mathcal{R}_0 \oplus 9\mathcal{R}'_0$ |
| $B(2,2)$ | $B(2,2)$ $D(2,2), B(1,2)$ $D(2,1), B(1,1)$ $D(2,1) \oplus B(0,1)$ $B(1,1) \oplus C(2)$ $C(2) \oplus C(2), A(0,1)$ $C(2), B(0,1)$ $A(1,0)$ | \mathcal{R}_2 $\mathcal{R}''_{3/2} \oplus 2\mathcal{R}_0$ $\mathcal{R}_1 \oplus 2\mathcal{R}''_0 \oplus 2\mathcal{R}_0$ $\mathcal{R}_1 \oplus \mathcal{R}''_{1/2} \oplus \mathcal{R}_0$ $2\mathcal{R}''_{1/2} \oplus 3\mathcal{R}_0$ $\mathcal{R}''_{1/2} \oplus 4\mathcal{R}_0 \oplus 2\mathcal{R}''_0$ $2\mathcal{R}_{1/2} \oplus \mathcal{R}_0 \oplus 2\mathcal{R}''_0$ | $\mathcal{R}_{7/2} \oplus \mathcal{R}_3 \oplus \mathcal{R}_{3/2} \oplus \mathcal{R}_1$ $\mathcal{R}_3 \oplus 3\mathcal{R}_{3/2} \oplus \mathcal{R}_1 \oplus \mathcal{R}_0$ $\mathcal{R}_{3/2} \oplus 3\mathcal{R}_1 \oplus 2\mathcal{R}'_1 \oplus 4\mathcal{R}_0 \oplus 4\mathcal{R}'_0$ $2\mathcal{R}_{3/2} \oplus 4\mathcal{R}_1 \oplus 2\mathcal{R}_{1/2}$ $3\mathcal{R}_1 \oplus 7\mathcal{R}_{1/2} \oplus 4\mathcal{R}_0$ $\mathcal{R}_1 \oplus 4\mathcal{R}_{1/2} \oplus 2\mathcal{R}'_{1/2} \oplus 9\mathcal{R}_0 \oplus 8\mathcal{R}'_0$ $\mathcal{R}_1 \oplus 7\mathcal{R}_{1/2} \oplus 2\mathcal{R}'_{1/2} \oplus 6\mathcal{R}_0 \oplus 2\mathcal{R}'_0$ |
| $B(3,1)$ | $D(2,1), B(1,1)$ $C(2), B(0,1)$ $A(1,0)$ | $\mathcal{R}_1 \oplus 4\mathcal{R}_0$ $\mathcal{R}''_{1/2} \oplus 6\mathcal{R}_0$ $2\mathcal{R}_{1/2} \oplus 3\mathcal{R}_0$ | $\mathcal{R}_{3/2} \oplus 5\mathcal{R}_1 \oplus 6\mathcal{R}_0$ $\mathcal{R}_1 \oplus 6\mathcal{R}_{1/2} \oplus 15\mathcal{R}_0$ $\mathcal{R}_1 \oplus 3\mathcal{R}_{1/2} \oplus 6\mathcal{R}'_{1/2} \oplus 6\mathcal{R}_0$ |

Table 23: $osp(1|2)$ decompositions of the $B(m, n)$ superalgebras of rank 4.

| \mathcal{G} | SSA in \mathcal{G} | Decomposition of the fundamental of \mathcal{G} | Decomposition of the adjoint of \mathcal{G} |
|---------------|-------------------------|--|---|
| $C(3)$ | $A(0, 1)$ $C(2)$ | $2\mathcal{R}''_{1/2}$ $\mathcal{R}''_{1/2} \oplus \mathcal{R}_0 \oplus 2\mathcal{R}''_0$ | $3\mathcal{R}_1 \oplus \mathcal{R}_{1/2} \oplus \mathcal{R}_0$ $\mathcal{R}_1 \oplus \mathcal{R}_{1/2} \oplus 2\mathcal{R}'_{1/2} \oplus 3\mathcal{R}_0 \oplus 2\mathcal{R}'_0$ |
| $C(4)$ | $A(0, 1)$ $C(2)$ | $2\mathcal{R}''_{1/2} \oplus 2\mathcal{R}''_0$ $\mathcal{R}''_{1/2} \oplus \mathcal{R}_0 \oplus 4\mathcal{R}''_0$ | $3\mathcal{R}_1 \oplus \mathcal{R}_{1/2} \oplus 4\mathcal{R}'_{1/2} \oplus 4\mathcal{R}_0$ $\mathcal{R}_1 \oplus \mathcal{R}_{1/2} \oplus 4\mathcal{R}'_{1/2} \oplus 10\mathcal{R}_0 \oplus 4\mathcal{R}'_0$ |

Table 24: $osp(1|2)$ decompositions of the $C(n+1)$ superalgebras up to rank 4.

| \mathcal{G} | SSA in \mathcal{G} | Decomposition of the fundamental of \mathcal{G} | Decomposition of the adjoint of \mathcal{G} |
|---------------|--|--|---|
| $D(2, 1)$ | $D(2, 1)$ $C(2)$ $A(1, 0)$ | $\mathcal{R}_1 \oplus \mathcal{R}_0$ $\mathcal{R}''_{1/2} \oplus 3\mathcal{R}_0$ $2\mathcal{R}_{1/2}$ | $\mathcal{R}_{3/2} \oplus 2\mathcal{R}_1$ $\mathcal{R}_1 \oplus 3\mathcal{R}_{1/2} \oplus 3\mathcal{R}_0$ $\mathcal{R}_1 \oplus 3\mathcal{R}_{1/2} \oplus 3\mathcal{R}_0$ |
| $D(2, 2)$ | $D(2, 2)$ $D(2, 1)$ $C(2)$ $C(2) \oplus C(2), A(0, 1)$ $B(1, 1) \oplus B(0, 1)$ $A(1, 0)$ | $\mathcal{R}''_{3/2} \oplus \mathcal{R}_0$ $\mathcal{R}_1 \oplus \mathcal{R}_0 \oplus 2\mathcal{R}''_0$ $\mathcal{R}''_{1/2} \oplus 3\mathcal{R}_0 \oplus 2\mathcal{R}''_0$ $\mathcal{R}''_{1/2} \oplus 2\mathcal{R}_0$ $\mathcal{R}_1 \oplus \mathcal{R}''_{1/2}$ $2\mathcal{R}_{1/2} \oplus 2\mathcal{R}''_0$ | $\mathcal{R}_3 \oplus 2\mathcal{R}_{3/2} \oplus \mathcal{R}_1$ $\mathcal{R}_{3/2} \oplus 2\mathcal{R}_1 \oplus 2\mathcal{R}'_1 \oplus 5\mathcal{R}_0$ $\mathcal{R}_1 \oplus 3\mathcal{R}_{1/2} \oplus 2\mathcal{R}'_{1/2} \oplus 6\mathcal{R}_0 \oplus 6\mathcal{R}'_0$ $3\mathcal{R}_1 \oplus 5\mathcal{R}_{1/2} \oplus 2\mathcal{R}_0$ $2\mathcal{R}_{3/2} \oplus 3\mathcal{R}_1 \oplus \mathcal{R}_{1/2}$ $\mathcal{R}_1 \oplus 7\mathcal{R}_{1/2} \oplus 6\mathcal{R}_0$ |
| $D(3, 1)$ | $D(2, 1)$ $C(2)$ $A(1, 0)$ | $\mathcal{R}_1 \oplus 3\mathcal{R}_0$ $\mathcal{R}''_{1/2} \oplus 5\mathcal{R}_0$ $2\mathcal{R}_{1/2} \oplus 2\mathcal{R}_0$ | $\mathcal{R}_{3/2} \oplus 4\mathcal{R}_1 \oplus 3\mathcal{R}_0$ $\mathcal{R}_1 \oplus 5\mathcal{R}_{1/2} \oplus 10\mathcal{R}_0$ $\mathcal{R}_1 \oplus 3\mathcal{R}_{1/2} \oplus 4\mathcal{R}'_{1/2} \oplus 4\mathcal{R}_0$ |

Table 25: $osp(1|2)$ decompositions of the $D(m, n)$ superalgebras up to rank 4.

| SSA in \mathcal{G} | Decomposition of the adjoint of \mathcal{G} |
|-------------------------|---|
| $A(1, 0)$ | $\mathcal{R}_1 \oplus 7\mathcal{R}_{1/2} \oplus 14\mathcal{R}_0$ |
| $A(0, 1)$ | $\mathcal{R}_1 \oplus 3\mathcal{R}_{1/2} \oplus 6\mathcal{R}'_{1/2} \oplus 6\mathcal{R}_0 \oplus 2\mathcal{R}'_0$ |
| $C(2)$ | $5\mathcal{R}_1 \oplus 3\mathcal{R}_{1/2} \oplus 6\mathcal{R}_0$ |
| $D(2, 1; 2)$ | $\mathcal{R}_{3/2} \oplus 2\mathcal{R}'_{3/2} \oplus 2\mathcal{R}_1 \oplus 2\mathcal{R}'_{1/2} \oplus 3\mathcal{R}_0$ |

Table 26: $osp(1|2)$ decompositions of the superalgebra $F(4)$.

| SSA in \mathcal{G} | Decomposition of the adjoint of \mathcal{G} |
|-------------------------|---|
| $A(1, 0)$ | $\mathcal{R}_1 \oplus 3\mathcal{R}_{1/2} \oplus 4\mathcal{R}'_{1/2} \oplus 3\mathcal{R}_0 \oplus 2\mathcal{R}'_0$ |
| $A(1, 0)'$ | $2\mathcal{R}'_{3/2} \oplus \mathcal{R}_1 \oplus 3\mathcal{R}_{1/2} \oplus 3\mathcal{R}_0$ |
| $B(0, 1)$ | $\mathcal{R}_1 \oplus 6\mathcal{R}_{1/2} \oplus 8\mathcal{R}_0$ |
| $B(1, 1)$ | $\mathcal{R}_{3/2} \oplus 2\mathcal{R}'_{3/2} \oplus \mathcal{R}_1 \oplus 3\mathcal{R}_0 \oplus 2\mathcal{R}'_0$ |
| $D(2, 1; 3)$ | $\mathcal{R}_2 \oplus \mathcal{R}_{3/2} \oplus 3\mathcal{R}_1$ |

Table 27: $osp(1|2)$ decompositions of the superalgebra $G(3)$.

| SSA in \mathcal{G} | Decomposition of the fundamental of \mathcal{G} | Decomposition of the adjoint of \mathcal{G} |
|-------------------------|--|---|
| $D(2, 1)$ | $\mathcal{R}_1 \oplus \mathcal{R}_0$ | $\mathcal{R}_{3/2} \oplus 2\mathcal{R}_1$ |
| $C(2)$ | $\mathcal{R}''_{1/2} \oplus 3\mathcal{R}_0$ | $\mathcal{R}_1 \oplus 3\mathcal{R}_{1/2} \oplus 3\mathcal{R}_0$ |
| $A(1, 0)$ | $2\mathcal{R}_{1/2}$ | $\mathcal{R}_1 \oplus 3\mathcal{R}_{1/2} \oplus 3\mathcal{R}_0$ |

Table 28: $osp(1|2)$ decompositions of the superalgebra $D(2, 1; \alpha)$.

| \mathcal{G} | SSA in \mathcal{G} | Decomposition of the fundamental of \mathcal{G} | Decomposition of the adjoint of \mathcal{G} |
|---------------|-------------------------|---|---|
| $A(0, 1)$ | $A(0, 1)$ | $\pi''(\frac{1}{2}, \frac{1}{2})$ | $\pi(0, 1)$ |
| $A(0, 2)$ | $A(0, 1)$ | $\pi''(\frac{1}{2}, \frac{1}{2}) \oplus \pi''(0, 0)$ | $\pi(0, 1) \oplus \pi'(\frac{1}{2}, \frac{1}{2}) \oplus \pi'(-\frac{1}{2}, \frac{1}{2}) \oplus \pi(0, 0)$ |
| $A(1, 1)$ | $A(0, 1)$ | $\pi''(\frac{1}{2}, \frac{1}{2}) \oplus \pi(0, 0)$ | $\pi(0, 1) \oplus \pi(\frac{1}{2}, \frac{1}{2}) \oplus \pi(-\frac{1}{2}, \frac{1}{2})$ |
| $A(0, 3)$ | $A(0, 1)$ | $\pi''(\frac{1}{2}, \frac{1}{2}) \oplus 2\pi''(0, 0)$ | $\pi(0, 1) \oplus 2\pi'(\frac{1}{2}, \frac{1}{2}) \oplus 2\pi'(-\frac{1}{2}, \frac{1}{2}) \oplus 4\pi(0, 0)$ |
| $A(1, 2)$ | $A(1, 2)$ | $\pi''(1, 1)$ | $\pi(0, 2) \oplus \pi(0, 1)$ |
| | $A(0, 1)$ | $\pi''(\frac{1}{2}, \frac{1}{2}) \oplus \pi(0, 0) \oplus \pi''(0, 0)$ | $\pi(0, 1) \oplus \pi(\frac{1}{2}, \frac{1}{2}) \oplus \pi(-\frac{1}{2}, \frac{1}{2})$ $\oplus \pi'(\frac{1}{2}, \frac{1}{2}) \oplus \pi'(-\frac{1}{2}, \frac{1}{2}) \oplus 2\pi(0, 0) \oplus 2\pi'(0, 0)$ |
| | $A(1, 0)$ | $\pi(\frac{1}{2}, \frac{1}{2}) \oplus 2\pi''(0, 0)$ | $\pi(0, 1) \oplus 2\pi(\frac{1}{2}, \frac{1}{2}) \oplus 2\pi(-\frac{1}{2}, \frac{1}{2}) \oplus 4\pi(0, 0)$ |

Table 29: $sl(1|2)$ decompositions of the $A(m, n)$ superalgebras up to rank 4.

| \mathcal{G} | SSA in \mathcal{G} | Decomposition of the fundamental of \mathcal{G} | Decomposition of the adjoint of \mathcal{G} |
|---------------|-------------------------|--|---|
| $B(1, 1)$ | $C(2)$ | $\pi''(0, \frac{1}{2}) \oplus \pi(0, 0)$ | $\pi(0, 1) \oplus \pi(0, \frac{1}{2})$ |
| $B(1, 2)$ | $C(2)$ | $\pi''(0, \frac{1}{2}) \oplus \pi(0, 0) \oplus 2\pi''(0, 0)$ | $\pi(0, 1) \oplus \pi(0, \frac{1}{2}) \oplus 2\pi'(0, \frac{1}{2})$ $\oplus 3\pi(0, 0) \oplus 2\pi'(0, 0)$ |
| | $A(0, 1)$ | $\pi''(\frac{1}{2}, \frac{1}{2}) \oplus \pi''(-\frac{1}{2}, \frac{1}{2}) \oplus \pi(0, 0)$ | $\pi(0, 1) \oplus \pi(1, 1) \oplus \pi(-1, 1)$ $\oplus \pi(\frac{1}{2}, \frac{1}{2}) \oplus \pi(-\frac{1}{2}, \frac{1}{2}) \oplus \pi(0, 0)$ |
| $B(2, 1)$ | $C(2)$ | $\pi''(0, \frac{1}{2}) \oplus 3\pi(0, 0)$ | $\pi(0, 1) \oplus 3\pi(0, \frac{1}{2}) \oplus 3\pi(0, 0)$ |
| | $A(1, 0)$ | $\pi(\frac{1}{2}, \frac{1}{2}) \oplus \pi(-\frac{1}{2}, \frac{1}{2}) \oplus \pi(0, 0)$ | $\pi(0, 1) \oplus \pi(\frac{3}{2}, \frac{1}{2}) \oplus \pi(-\frac{3}{2}, \frac{1}{2})$ $\oplus \pi'(\frac{1}{2}, \frac{1}{2}) \oplus \pi'(-\frac{1}{2}, \frac{1}{2}) \oplus \pi(0, 0)$ |

Table 30: $sl(1|2)$ decompositions of the $B(m, n)$ superalgebras of rank 2 and 3.

| \mathcal{G} | SSA in \mathcal{G} | Decomposition of the fundamental of \mathcal{G} | Decomposition of the adjoint of \mathcal{G} |
|---------------|-------------------------|---|---|
| $B(1, 3)$ | $A(0, 1)$ | $\pi''(\frac{1}{2}, \frac{1}{2}) \oplus \pi''(-\frac{1}{2}, \frac{1}{2})$ $\oplus \pi(0, 0) \oplus 2\pi''(0, 0)$ | $\pi(0, 1) \oplus \pi(1, 1) \oplus \pi(-1, 1)$ $\oplus \pi(\frac{1}{2}, \frac{1}{2}) \oplus \pi(-\frac{1}{2}, \frac{1}{2}) \oplus 2\pi'(\frac{1}{2}, \frac{1}{2})$ $\oplus 2\pi'(-\frac{1}{2}, \frac{1}{2}) \oplus 4\pi(0, 0) \oplus 2\pi'(0, 0)$ |
| | $C(2)$ | $\pi''(0, \frac{1}{2}) \oplus 4\pi''(0, 0) \oplus \pi(0, 0)$ | $\pi(0, 1) \oplus \pi(0, \frac{1}{2}) \oplus 4\pi'(0, \frac{1}{2})$ $\oplus 10\pi(0, 0) \oplus 4\pi'(0, 0)$ |
| $B(2, 2)$ | $2 C(2)$ | $2\pi''(0, \frac{1}{2}) \oplus \pi(0, 0)$ | $3\pi(0, 1) \oplus 2\pi(0, \frac{1}{2}) \oplus \pi(0; -\frac{1}{2}, \frac{1}{2}; 0)$ |
| | $A(0, 1)$ | $\pi''(\frac{1}{2}, \frac{1}{2}) \oplus \pi''(-\frac{1}{2}, \frac{1}{2}) \oplus 3\pi(0, 0)$ | $\pi(0, 1) \oplus \pi(1, 1) \oplus \pi(-1, 1)$ $\oplus 3\pi'(\frac{1}{2}, \frac{1}{2}) \oplus 3\pi'(-\frac{1}{2}, \frac{1}{2}) \oplus 4\pi(0, 0)$ |
| | $C(2)$ | $\pi''(0, \frac{1}{2}) \oplus 3\pi(0, 0) \oplus 2\pi''(0, 0)$ | $\pi(0, 1) \oplus 3\pi(0, \frac{1}{2}) \oplus 2\pi'(0, \frac{1}{2})$ $\oplus 6\pi(0, 0) \oplus 6\pi'(0, 0)$ |
| $B(3, 1)$ | $A(1, 0)$ | $\pi(\frac{1}{2}, \frac{1}{2}) \oplus \pi(-\frac{1}{2}, \frac{1}{2})$ $\oplus \pi(0, 0) \oplus 2\pi''(0, 0)$ | $\pi(0, 1) \oplus \pi(\frac{3}{2}, \frac{1}{2}) \oplus \pi(-\frac{3}{2}, \frac{1}{2})$ $\oplus 2\pi(\frac{1}{2}, \frac{1}{2}) \oplus 2\pi(-\frac{1}{2}, \frac{1}{2}) \oplus \pi'(\frac{1}{2}, \frac{1}{2})$ $\oplus \pi'(-\frac{1}{2}, \frac{1}{2}) \oplus 4\pi(0, 0) \oplus 2\pi'(0, 0)$ |
| | $C(2)$ | $\pi''(0, \frac{1}{2}) \oplus 5\pi(0, 0)$ | $\pi(0, 1) \oplus 5\pi(0, \frac{1}{2}) \oplus 10\pi(0, 0)$ |
| | $A(1, 0)$ | $\pi(\frac{1}{2}, \frac{1}{2}) \oplus \pi(-\frac{1}{2}, \frac{1}{2}) \oplus 3\pi(0, 0)$ | $\pi(0, 1) \oplus \pi(\frac{3}{2}, \frac{1}{2}) \oplus \pi(-\frac{3}{2}, \frac{1}{2})$ $\oplus 3\pi'(\frac{1}{2}, \frac{1}{2}) \oplus 3\pi'(-\frac{1}{2}, \frac{1}{2}) \oplus 4\pi(0, 0)$ |

Table 31: $sl(1|2)$ decompositions of the $B(m, n)$ superalgebras of rank 4.

| \mathcal{G} | SSA in \mathcal{G} | Decomposition of the fundamental of \mathcal{G} | Decomposition of the adjoint of \mathcal{G} |
|---------------|-------------------------|--|---|
| $C(3)$ | $A(0, 1)$ $C(2)$ | $\pi''(\frac{1}{2}, \frac{1}{2}) \oplus \pi''(-\frac{1}{2}, \frac{1}{2})$ $\pi''(0, \frac{1}{2}) \oplus 2\pi''(0, 0)$ | $\pi(0, 1) \oplus \pi(1, 1) \oplus \pi(-1, 1) \oplus \pi(0, 0)$ $\pi(0, 1) \oplus 2\pi'(0, \frac{1}{2}) \oplus 3\pi(0, 0)$ |
| $C(4)$ | $A(0, 1)$ $C(2)$ | $\pi''(\frac{1}{2}, \frac{1}{2}) \oplus \pi''(-\frac{1}{2}, \frac{1}{2}) \oplus 2\pi''(0, 0)$ $\pi''(0, \frac{1}{2}) \oplus 4\pi''(0, 0)$ | $\pi(0, 1) \oplus \pi(1, 1) \oplus \pi(-1, 1)$ $\oplus 2\pi'(\frac{1}{2}, \frac{1}{2}) \oplus 2\pi'(-\frac{1}{2}, \frac{1}{2}) \oplus 4\pi(0, 0)$ $\pi(0, 1) \oplus 4\pi'(0, \frac{1}{2}) \oplus 10\pi(0, 0)$ |

Table 32: $sl(1|2)$ decompositions of the $C(n+1)$ superalgebras up to rank 4.

| \mathcal{G} | SSA in \mathcal{G} | Decomposition of the fundamental of \mathcal{G} | Decomposition of the adjoint of \mathcal{G} |
|---------------|-------------------------|--|---|
| $D(2, 1)$ | $C(2)$ $A(1, 0)$ | $\pi''(0, \frac{1}{2}) \oplus 2\pi(0, 0)$ $\pi(\frac{1}{2}, \frac{1}{2}) \oplus \pi(-\frac{1}{2}, \frac{1}{2})$ | $\pi(0, 1) \oplus 2\pi(0, \frac{1}{2}) \oplus \pi(0, 0)$ $\pi(0, 1) \oplus \pi(\frac{3}{2}, \frac{1}{2}) \oplus \pi(-\frac{3}{2}, \frac{1}{2}) \oplus \pi(0, 0)$ |
| $D(2, 2)$ | $C(2)$ $2 C(2)$ | $\pi''(0, \frac{1}{2}) \oplus 2\pi(0, 0) \oplus 2\pi''(0, 0)$ $2\pi''(0, \frac{1}{2})$ | $\pi(0, 1) \oplus 2\pi(0, \frac{1}{2}) \oplus 2\pi'(0, \frac{1}{2})$ $\oplus 4\pi(0, 0) \oplus 4\pi'(0, 0)$ $3\pi(0, 1) \oplus \pi(0; -\frac{1}{2}, \frac{1}{2}; 0)$ |
| | $A(0, 1)$ | $\pi''(\frac{1}{2}, \frac{1}{2}) \oplus \pi''(-\frac{1}{2}, \frac{1}{2}) \oplus 2\pi(0, 0)$ | $\pi(0, 1) \oplus \pi(1, 1) \oplus \pi(-1, 1)$ $\oplus 2\pi(\frac{1}{2}, \frac{1}{2}) \oplus 2\pi(-\frac{1}{2}, \frac{1}{2}) \oplus 2\pi(0, 0)$ |
| | $A(1, 0)$ | $\pi(\frac{1}{2}, \frac{1}{2}) \oplus \pi(-\frac{1}{2}, \frac{1}{2}) \oplus 2\pi''(0, 0)$ | $\pi(0, 1) \oplus \pi(\frac{3}{2}, \frac{1}{2}) \oplus \pi(-\frac{3}{2}, \frac{1}{2})$ $\oplus 2\pi(\frac{1}{2}, \frac{1}{2}) \oplus 2\pi(-\frac{1}{2}, \frac{1}{2}) \oplus 4\pi(0, 0)$ |
| $D(3, 1)$ | $C(2)$ $A(1, 0)$ | $\pi''(0, \frac{1}{2}) \oplus 4\pi(0, 0)$ $\pi(\frac{1}{2}, \frac{1}{2}) \oplus \pi(-\frac{1}{2}, \frac{1}{2}) \oplus 2\pi(0, 0)$ | $\pi(0, 1) \oplus 4\pi(0, \frac{1}{2}) \oplus 6\pi(0, 0)$ $\pi(0, 1) \oplus \pi(\frac{3}{2}, \frac{1}{2}) \oplus \pi(-\frac{3}{2}, \frac{1}{2})$ $\oplus 2\pi'(\frac{1}{2}, \frac{1}{2}) \oplus 2\pi'(-\frac{1}{2}, \frac{1}{2}) \oplus 2\pi(0, 0)$ |

Table 33: $sl(1|2)$ decompositions of the $D(m, n)$ superalgebras up to rank 4.

| \mathcal{G} | SSA in \mathcal{G} | Decomposition of the adjoint of \mathcal{G} |
|-----------------|-------------------------|--|
| $F(4)$ | $A(1,0)$ | $(0,1) \oplus 3\pi(\frac{1}{6}, \frac{1}{2}) \oplus 3\pi(-\frac{1}{6}, \frac{1}{2}) \oplus 8\pi(0,0)$ |
| | $A(0,1)$ | $\pi(0,1) \oplus \pi(1, \frac{1}{2}) \oplus \pi(-1, \frac{1}{2}) \oplus 4\pi(0,0)$ $\oplus 2\pi'(\frac{1}{2}, \frac{1}{2}) \oplus 2\pi'(-\frac{1}{2}, \frac{1}{2}) \oplus 2\pi'(0, \frac{1}{2})$ |
| | $C(2)$ | $\pi(0,1) \oplus 2\pi(1,1) \oplus 2\pi(-1,1)$ $\oplus \pi(\frac{5}{2}, \frac{1}{2}) \oplus \pi(-\frac{5}{2}, \frac{1}{2}) \oplus 4\pi(0,0)$ |
| $G(3)$ | $A(1,0)$ | $\pi(0,1) \oplus \pi(\frac{5}{6}, \frac{1}{2}) \oplus \pi(-\frac{5}{6}, \frac{1}{2}) \oplus \pi'(\frac{1}{6}, \frac{1}{2})$ $\oplus \pi'(-\frac{1}{6}, \frac{1}{2}) \oplus \pi'(\frac{1}{2}, \frac{1}{2}) \oplus \pi'(-\frac{1}{2}, \frac{1}{2}) \oplus \pi(0,0)$ |
| | $A(1,0)'$ | $\pi(0,1) \oplus \pi(\frac{7}{2}, \frac{1}{2}) \oplus \pi(-\frac{7}{2}, \frac{1}{2})$ $\oplus \pi'(\frac{3}{2}, \frac{3}{2}) \oplus \pi'(-\frac{3}{2}, \frac{3}{2}) \oplus \pi(0,0)$ |
| | $C(2)$ | $\pi(0,1) \oplus 2\pi(\frac{1}{4}, \frac{1}{2}) \oplus 2\pi(-\frac{1}{4}, \frac{1}{2}) \oplus \pi(0, \frac{1}{2})$ |
| $D(2,1;\alpha)$ | $A(1,0)$ | $\pi(0,1) \oplus \pi(\frac{1}{2}(2\alpha+1), \frac{1}{2}) \oplus \pi(-\frac{1}{2}(2\alpha+1), \frac{1}{2}) \oplus \pi(0,0)$ |
| | $A(1,0)'$ | $\pi(0,1) \oplus \pi(\frac{1}{2}(\frac{1-\alpha}{1+\alpha}), \frac{1}{2}) \oplus \pi(-\frac{1}{2}(\frac{1-\alpha}{1+\alpha}), \frac{1}{2}) \oplus \pi(0,0)$ |
| | $C(2)$ | $\pi(0,1) \oplus \pi(\frac{1}{2}(\frac{2+\alpha}{\alpha}), \frac{1}{2}) \oplus \pi(-\frac{1}{2}(\frac{2+\alpha}{\alpha}), \frac{1}{2}) \oplus \pi(0,0)$ |

Table 34: $sl(1|2)$ decompositions of the exceptional superalgebras.

Let us remark that for $D(2,1;\alpha)$ from any $sl(1|2)$ decomposition one gets the two others by replacing α by one of the values α^{-1} , $-1-\alpha$, $\frac{-\alpha}{1+\alpha}$. This corresponds to isomorphic versions of the exceptional superalgebra $D(2,1;\alpha)$ (\rightarrow). One can check this triality-like property, which certainly deserves some developments, by the studying the completely odd Dynkin diagram of $D(2,1;\alpha)$.

References

- [1] D. Arnaudon, M. Bauer, L. Frappat, *On Casimir's ghost*, preprint ENSLAPP-A-587/96, q-alg/9605021.
- [2] J. Bagger, J. Wess, *Supersymmetry and supergravity*, Princeton Series in Physics, Princeton (1983).
- [3] A.B. Balantekin, I. Bars, *Dimension and character formulas for Lie supergroups*, J. Math. Phys. **22** (1981) 1149 and *Representations of supergroups*, J. Math. Phys. **22** (1981) 1810.
- [4] A.B. Balantekin, I. Bars, F. Iachello, *$U(6|4)$ dynamical supersymmetry in nuclei*, Phys. Rev. Lett. **47** (1981) 19.
- [5] F.A. Berezin, V.N. Tolstoy, *The group with Grassmann structure $UOSP(1|2)$* , Commun. Math. Phys. **78** (1981) 409.
- [6] A. Della Selva, A. Sciarrino, *Realization of exceptional superalgebras in terms of fermion-boson creation-annihilation operators*, J. Math. Phys. **33** (1992) 1538.
- [7] B.S. DeWitt, P. van Nieuwenhuizen, *Explicit construction of the exceptional superalgebras $F(4)$ and $G(3)$* , J. Math. Phys. **23** (1982) 1953.
- [8] R. Floreanini, D. Leites, L. Vinet, *On the defining relations of quantum superalgebras*, Lett. Math. Phys. **23** (1991) 127.
- [9] L. Frappat, E. Ragoucy, P. Sorba, *\mathcal{W} -algebras and superalgebras from constrained WZNW models: a group-theoretical classification*, Commun. Math. Phys. **157** (1993) 499.
- [10] L. Frappat, A. Sciarrino, P. Sorba, *Structure of basic Lie superalgebras and of their affine extensions*, Commun. Math. Phys. **121** (1989) 457.
- [11] L. Frappat, A. Sciarrino, P. Sorba, *Dynkin-like diagrams and representations of the strange superalgebra $P(n)$* , J. Math. Phys. **32** (1991) 3268 and *Oscillator realization of the strange superalgebras $P(n)$ and $Q(n)$* , J. Math. Phys. **33** (1992) 3911.
- [12] P.G.O. Freund, I. Kaplansky, *Simple supersymmetries*, J. Math. Phys. **17** (1976) 228.
- [13] H.S. Green, P.D. Jarvis, *Casimir invariants and characteristic identities for generators of the general linear, special linear and orthosymplectic graded Lie algebras*, J. Math. Phys. **20** (1979) 2115.

- [14] J.P. Hurni, *Young supertableaux of the basic Lie superalgebras*, J. Phys. A: Math. Gen. **20** (1987) 5755.
- [15] J.P. Hurni, B. Morel, *Irreducible representations of superalgebras of type II*, J. Math. Phys. **23** (1982) 2286.
- [16] J.P. Hurni, B. Morel, *Irreducible representations of $su(m|n)$* , J. Math. Phys. **24** (1983) 157.
- [17] F. Iachello, *Dynamical supersymmetries in nuclei*, Phys. Rev. Lett. **44** (1980) 772.
- [18] I.F. Istomina, Yu.F. Smirnov, V.N. Tolstoi, *The Gelfand-Zetlin basis for the Lie superalgebra $gl(n|m)$* , in Yurmala 1985, Proceedings, Group theoretical methods in physics, vol. 1, p. 337.
- [19] P.D. Jarvis, M.K. Murray, *Casimir invariants, characteristic identities and tensor operators for strange superalgebras*, J. Math. Phys. **24** (1983) 1705.
- [20] V.G. Kac, *Classification of Lie Superalgebras*, Funct. Anal. Appl. **9** (1975) 263.
- [21] V.G. Kac, *Lie Superalgebras*, Adv. Math. **26** (1977) 8.
- [22] V.G. Kac, *A sketch of Lie superalgebra theory*, Commun. Math. Phys. **53** (1977) 31.
- [23] V.G. Kac, *Characters of typical representations of classical Lie superalgebras*, Commun. Algebra **5** (1977) 889.
- [24] V.G. Kac, *Representations of classical Lie superalgebras*, Lectures Notes in Mathematics **676** (1978) 597; Springer-Verlag, Berlin.
- [25] D.A. Leites, M.V. Saveliev, V.V. Serganova, *Embeddings of Lie superalgebra $osp(1|2)$ and the associated nonlinear supersymmetric equations*, in "Group Theoretical Methods in Physics", Markov M.A., Man'ko V.I. and Dodonov V.V. eds., p.255, VUN Science Press, Utrecht, The Netherlands (1986).
- [26] D.A. Leites, V.V. Serganova, *Defining relations for classical Lie superalgebras*, Proceedings of the Euler IMI conference on quantum groups, Leningrad (1990).
- [27] M. Marcu, *The representations of $spl(2|1)$: an example of representations of basic superalgebras*, J. Math. Phys. **21** (1980) 1277 and *The tensor product of two irreducible representations of the $spl(2|1)$ superalgebra*, J. Math. Phys. **21** (1980) 1284.

- [28] B. Morel, A. Sciarrino, P. Sorba, *Representations of $osp(M|2n)$ and Young supertableaux*, J. Phys. A: Math. Gen. **18** (1985) 1597.
- [29] W. Nahm, V. Rittenberg, M. Scheunert, *Classification of all simple graded Lie algebras whose Lie algebra is reductive. 1*, J. Math. Phys. **17** (1976) 1626 and *Classification of all simple graded Lie algebras whose Lie algebra is reductive. 2 (construction of the exceptional algebras)*, J. Math. Phys. **17** (1976) 1640.
- [30] W. Nahm, V. Rittenberg, M. Scheunert, *Graded Lie algebras: generalization of hermitian representations*, J. Math. Phys. **18** (1977) 146 and *Irreducible representations of the $osp(1, 2)$ and $spl(1, 2)$ graded Lie algebras*, J. Math. Phys. **18** (1977) 155.
- [31] A. Pais, V. Rittenberg, *Semi-simple graded Lie algebras*, J. Math. Phys. **16** (1975) 2062, Erratum ibid. **17** (1976) 598.
- [32] M. Parker, *Classification of real simple Lie superalgebras of classical type*, J. Math. Phys. **21** (1980) 689.
- [33] E. Ragoucy, A. Sevrin, P. Sorba, *Strings from $N = 2$ gauged Wess-Zumino-Witten models*, Commun. Math. Phys. **XXX** (1996).
- [34] V. Rittenberg, *A guide to Lie superalgebras*, Proceedings of the VIth ICGTMP, Tübingen (1977), Lecture Notes in Physics **79**; Springer-Verlag, Heidelberg (1978).
- [35] V. Rittenberg, M. Scheunert, *Elementary construction of graded Lie groups*, J. Math. Phys. **19** (1978) 709.
- [36] V. Rittenberg, M. Scheunert, *A remarkable connection between the representations of the Lie superalgebras $osp(1|2N)$ and the Lie algebras $o(2N + 1)$* , Commun. Math. Phys. **83** (1982) 1.
- [37] M. Scheunert, *The theory of Lie superalgebras: an introduction*, Lectures Notes in Mathematics **716** (1979) 271; Springer-Verlag, Berlin.
- [38] M. Scheunert, *Casimir elements of ϵ Lie algebras*, J. Math. Phys. **24** (1983) 2671 and *Eigenvalues of Casimir operators for the general linear, the special linear and the orthosymplectic Lie superalgebras*, J. Math. Phys. **24** (1983) 2681.
- [39] M. Scheunert, *The presentation and q -deformation of special linear Lie superalgebras*, J. Math. Phys. **34** (1993) 3780.

- [40] A. Sciarrino, P. Sorba, *Lie algebras for physicists*, in "Formulae and methods in experimental data evaluation", vol. 1, European Physical Society, 1984.
- [41] A. Sciarrino, P. Sorba, *Representations of the superalgebra F_4 and Young super tableaux*, J. Phys. A: Math. Gen. **19** (1986) 2241.
- [42] A. Sciarrino, P. Sorba, *Representations of the Lie superalgebra G_3* , Proceedings of the XVth ICGTMP, Philadelphie (1986); World Scientific, Singapore (1987).
- [43] V.V. Serganova, *Automorphisms of simple Lie superalgebras*, Math. USSR Izvest. **24** (1985) 539.
- [44] M. Sohnius, *Introducing supersymmetry*, Phys. Rep. **128** (1985) 39.
- [45] D.S. Tang, *Formal relations between classical superalgebras and fermion-boson creation and annihilation operators*, J. Math. Phys. **25** (1984) 2966.
- [46] J. Thierry-Mieg, *Table des représentations irréductibles des superalgèbres de Lie*, (1983) unpublished.
- [47] J. Van der Jeugt, *Irreducible representations of the exceptional Lie superalgebra $D(2, 1; \alpha)$* , J. Math. Phys. **26** (1985) 913.
- [48] J. Van der Jeugt, *Regular subalgebras of Lie superalgebras and extended Dynkin diagrams*, J. Math. Phys. **28** (1987) 292.
- [49] J. Van der Jeugt, J.W.B. Hughes, R.C. King, J. Thierry-Mieg, *A character formula for singly atypical modules of the Lie superalgebras $sl(m|n)$* , Journ. Alg. (1990) and *Character formulae for irreducible modules of the Lie superalgebras $sl(m|n)$* , J. Math. Phys. **31** (1990) 2278.
- [50] J.W. Van der Leur, *Contragredient Lie superalgebras of finite growth*, Utrecht thesis (1985).
- [51] P. West, *Introduction to supersymmetry and supergravity*, World Scientific, Singapore (1986).
- [52] H. Yamane, *Quantized enveloping algebras associated to simple and affine Lie superalgebras*, Proceedings of the XXth ICGTMP, Toyonaka (1994); World Scientific, Singapore (1995).